

DEPARTMENT OF MINES WESTERN AUSTRALIA 1972

MINES
ANNUAL REPORT
1972

R E P O R T O F T H E
DEPARTMENT *of* MINES
W E S T E R N A U S T R A L I A
F O R T H E Y E A R 1 9 7 2

Presented to both Houses of Parliament by His Excellency's Command

006287 MD11B U



By Authority:
1973

19903/8/73

To Hon. Minister for Mines.

Sir,

I have the honour to submit the Annual Report of the Department of Mines of the State of Western Australia for the year 1972, together with the reports from the officers controlling Sub-Departments, and Comparative Tables furnishing statistics relative to the Mining Industry.

*G. H. COOPER,
Under Secretary for Mines.*

Perth, 1973.

TABLE OF CONTENTS

DIVISION I.

	Page
Part 1.—General Remarks	7
Iron Ore	7
Petroleum	7
Gold	7
Coal	8
Alumina	8
Nickel	8
Other Minerals	8
Part 2.—Comparative Statistics, 1971 and 1972	
Table 1.—Summary of Mineral Production	9
Table 1 (a).—Quantity and Value of Minerals produced other than Gold and Silver	10
Table 1 (b).—Quantity and Value of Gold and Silver exported and minted	10
Table 2.—Royalties	11
Table 3.—Amount of Gold reported from each Goldfield	11
Diagram of Gold output, value and tonnage, 1915–1972	Facing 12
Table 4.—Output of Gold from the Commonwealth of Australia	12
Table 5.—Coal output, value, men employed, output per man	12
Graph of Coal output, value and tonnage, 1943–1972	Facing 12
Graph of Coal output of deep and open-cut tonnages, 1955–1972	Facing 12
Table 6.—Mining Tenements applied for and in force under the Mining Act	13
Table 6 (a).—Mining Leases applied for and in force under Special Acts	13
Table 6 (b).—Permits, Licences and Leases applied for and in force under the Petroleum Act	14
Table 6 (c).—Leases under the Mining Act in force in each Goldfield, Mineral field or District	14
Table 6 (d).—Claims and Authorised Holdings under the Mining Act in force in each Goldfield, Mineral field or District	15
Table 7.—Average number of men engaged in mining	16
Part 3.—State Aid to Mining—	
State Batteries	17
Prospecting Scheme	17
Geological Survey	17
Part 4.—Government Chemical Laboratories	17
Part 5.—Explosives Branch	17
Part 6.—Mine Workers' Relief Act and Miners' Phthisis Act	17
Part 7.—Surveys and Mapping Branch	17
Part 8.—Staff	17

DIVISION II.

Report of the State Mining Engineer	19
-------------------------------------------	----

DIVISION III.

Report of the Superintendent of State Batteries	41
Return of Parcels treated and Tons crushed at State Batteries for year 1972	43
Tailings Treatment, 1972	43
Statement of Revenue and Expenditure for year (Milling)	44
Statement of Revenue and Expenditure for year (Tailings Treatment)	45

DIVISION IV.

Report of the Director, Geological Survey	47
-------------------------------------------------	----

DIVISION V.

Report of the Superintendent, Surveys and Mapping	141
---------------------------------------------------------	-----

DIVISION VI.

Report of the Director, Government Chemical Laboratories	149
----------------------------------------------------------------	-----

DIVISION VII.

Report of the Chief Inspector of Explosives	185
---------------------------------------------------	-----

DIVISION VIII.

Report of the Chairman, Miners' Phthisis Board and Superintendent, Mines Workers' Relief Act	189
----------------------------------------------------------------------------------------------------	-----

STATISTICS.

Mining Statistics	193
-------------------------	-----

WESTERN AUSTRALIA

Report of the Department of Mines for the Year 1972

DIVISION I

PART 1—GENERAL REMARKS

The Honourable Minister for Mines:

I have the honour to submit for your information a report on the Mining Industry for the year 1972.

The estimated value of the mineral output of the State (including gold, coal and petroleum) for the year was \$648,544,244 an increase of \$2,025,181 compared with that for the preceding year. Though this value was an all-time record the increase was not significant due in the main to the devaluation of the American dollar in which the State's major mineral export contracts are written.

Royalty revenue was similarly affected and increased only marginally from \$24.5 million in 1971 to \$24.8 million in 1972.

To the end of 1972 the progressive value of the whole mineral production of the State amounted to \$3,984,955,649 of which gold accounted for \$1,122,416,975.

IRON ORE

Iron ore is the State's leading mineral, a position it attained in 1967 by displacing gold which had held that distinction for 75 years.

There are now six companies in Western Australia producing iron ore products, the last mine to come on stream being the Robe River project established under the Iron Ore (Cleveland-Cliffs) Agreement which commenced export from its new port at Cape Lambert in October, 1972.

Iron ore production for export and local use continued to grow, rising from 51.2 million tons in 1971 to 54.5 million tons in 1972; however the value fell from \$385 million in 1971 to \$384 million in 1972 due mainly, as mentioned previously, to the devaluation of the American dollar.

PETROLEUM

(Crude Oil)

Sales of oil from Barrow Island during 1972 were down slightly from 16.4 million barrels valued at \$36.5 million in 1971 to 15.4 million barrels valued at \$34.3 million in 1972.

(Natural Gas)

The natural gas production from the Dongara and Mondarra gas fields increased from a rate of 33 million cubic feet per day in January, 1972, to 81 million cubic feet per day at the end of the year. Further increases in production rate will depend on the discovery and development of additional natural gas reserves.

Offshore exploration drilling activity continued with an average of three rigs in operation throughout the year. Activity was mainly centred on the North West Shelf. A new discovery of natural gas/condensate was made at the Angel No. 1 well and an oil discovery at the Eagle Hawk No. 1 well. Appraisal drilling and testing of these structures is required to evaluate their commercial significance.

On land promising shows of natural gas were obtained during the drilling of the Barrow Island Deep Test well.

GOLD

The estimated value of gold received at the Perth Mint was \$16,042,688, an increase of \$4,121,118 compared with the figure for 1971. This increase was due almost entirely to the very high premiums obtained on the free market. The quantity of gold advised as being received at the Mint was 348,851.74 fine ounces, an increase of only 842 fine ounces over the previous year's production.

Details of gold production for the year reported directly to the Department, as distinct from that received at the Mint, are set out in Table 1. The total tonnage of gold ore treated was 1,645,000 being 30,000 tons less than for 1971.

West Australian gold included in sales on overseas premium markets by the Gold Producers' Association Ltd for the period September, 1971, to September, 1972, (both months inclusive) amounted to 367,539 fine ounces. The premium received in excess of the Mint value amounted to \$5,159,246, an overall average of \$14.0354 per fine ounce as compared with an average of \$3.7868 per fine ounce for the period from September, 1970, to August, 1971.

Subsidy payments by the Commonwealth Government during the year under the Gold-Mining Industry Assistance Act totalled \$1,083,369, a decrease of \$740,407 compared with the previous year. This decrease in subsidy payments is the result of higher prices obtained for gold sold on the free market. Where a producer receives an amount in excess of the official price (\$29.80 per fine ounce as from 23rd December, 1972, and previously \$31.25) as a result of sales on overseas premium markets or otherwise, the subsidy payable is, with effect from 1st January, 1972, reduced by fifty per cent of the amount of the excess. Prior to that date the subsidy was reduced by seventy-five per cent of the excess. Of the subsidy paid, \$1,061,115 went to large producers and \$22,254 went to small producers.

COAL

Coal production from Collie during the year showed a decrease of 22,523 tons against that for 1971 and the overall average value per ton rose by 2.39 cents.

Figures for the last three years were:—

	1970	1971	1972
Tons	1,197,734	1,171,624	1,149,101
Total Value	\$5,827,291	\$5,734,353	\$5,907,162
Average value per ton	\$4.8653	\$4.8943	\$5.1333
Average Effective Workers	635	623	617
Proportion of Deep Mined Coal	39.02%	34.86%	36.19%

ALUMINA

(from Bauxite)

Production of alumina continued to increase with the commencement of operation of the new refinery at Pinjarra in the second quarter of 1972. Alcoa of Australia (W.A.) N.L. increased its output for 1972 to 1.4 million tons of calcined alumina having an estimated value of about \$90 million. Tonnage increase over that for 1971 was 158,000.

NICKEL

The total value of nickel in concentrates and nickel briquettes and powder amounted to an estimated \$34.4 million as against \$95 million in 1971. This decrease in value was due very largely to the devaluation of the US dollar although a small drop

in the quantity of ore and concentrates treated also had some effect. The average number of men employed in nickel mining decreased by 57 from 1,861 in 1971 to 1,804 in 1972.

OTHER MINERALS

Other minerals to yield over a million dollars for the year were: Salt \$6.2 million, Ilmenite \$5.9 million, Tin Concentrates \$4.3 million, Zircon \$1.6 million, Manganese \$1.5 million, Tanto/Columbite Concentrates \$1.2 million and Limestone \$1.2 million, whilst Pig Iron valued at \$4 million was recovered by the Charcoal Iron and Steel Industry at Wundowie.

OUTLOOK

The year 1972 saw a recession in iron ore exports to Japan, deliveries hampered by a prolonged shipping strike, a devaluation of the American dollar and depressed metal prices generally on world markets with the result that the value of the State's mineral production showed only a marginal increase of \$2 million above the figure of \$646.5 million for the previous year. However, the substantial increase in assistance to the gold-mining industry granted by the Commonwealth Government as from 1st January, 1972, the rising price of gold on the free markets throughout the world, and, by the end of the year, clear indications of reinvigorated world trade generally—in particular the iron and steel industry—all augur well for the continued development and prosperity of the State's mineral industry.

PART 2—COMPARATIVE STATISTICS

**TABLE 1
SUMMARY**

Mineral Production : Quantity, Value, Persons Engaged

	1971	1972	Variation	
IRON ORE—				
<i>Reported to Department—</i>				
Tons	51,297,774	54,861,768	+	3,363,994
Value (\$A)	\$388,706,948	\$387,998,067	—	\$708,881
Persons Engaged	2,754	2,826	+	72
PETROLEUM—CRUDE OIL—				
<i>Reported to Department—</i>				
Barrels	16,352,920	15,402,695	—	950,225
† Value (\$A)	\$36,466,886	\$34,346,900	—	\$2,119,986
Persons Engaged—				
Effective Workers (excluding absentees)	106	133	+	27
GOLD—				
<i>Reported to Department (Mine Production)—</i>				
Ore Tons	1,675,109	1,644,877	—	30,232
Gold (fine ounces)	344,757	336,871	—	7,886
Average Grade (dwts. per ton)	4.116	4.117	+	.001
Persons Engaged—				
(a) Effective Workers (excluding absentees)	1,775	1,982	+	207
(b) Total Pay Roll	1,962	2,165	+	203
<i>Mint and Export (Realised Production)—</i>				
Gold (fine ounces)	348,009	348,852	+	843
Estimated Value (\$A) (including Overseas Gold Sales Premium)	\$11,921,570	\$16,042,688	+	\$4,121,118
COAL—				
<i>Reported to Department (Mine Production)—</i>				
Tons	1,171,624	1,167,540	—	22,885
Value (\$A)	\$5,734,353	\$5,907,162	+	\$172,809
Persons Engaged—				
Effective Workers (excluding absentees)	623	617	—	6
OTHER MINERALS—				
<i>Reported to Department—</i>				
Value (\$A)	\$203,689,306	\$204,249,427	+	\$560,121
Persons Engaged—				
Effective Workers (excluding absentees)	4,244	4,389	+	145
TOTAL ALL MINERALS—				
Value (\$A)	\$646,519,063	\$648,544,244	+	\$2,025,181
Persons Engaged—				
Effective Workers	9,502	9,947	+	445

† Based on the price assessed from time to time by the Tariff Board for Barrow Island crude oil at Kwinana.

TABLE 1 (a)
Quantity and Value of Minerals, other than Gold and Silver, produced during Years 1971 and 1972
Western Australia

Mineral	1971		1972		Increase or Decrease for Year Compared with 1971	
	Quantity	Value	Quantity	Value	Quantity	Value
Alumina (from Bauxite)	Tons 1,255,209.00	\$A 80,333,200	tons 1,413,182.00	\$A 90,443,400	tons + 157,973.00	\$A + 10,110,200
Asbestos (Chrysotile)	50.60	2,125	50.60	2,125
Beryl	63.42	17,703	61.49	12,870	1.93	4,833
Building Stone (Quartzite)	1,269.00	5,490	1,091.00	4,410	178.00	1,080
(Quartz)	9,838.00	117,077	3,781.00	37,810	6,057.00	79,267
(Granite—Facing Stone)	638.00	18,016	60.00	5,400	578.00	12,616
(Sandstone)	30.00	180	30.00	180
(Spongolite)	145.00	1,965	90.50	1,267	54.50	698
(Quartz Crystal)	210.00	3,192	210.00	3,192
Clays (Bentonite)	20.00	120	162.00	2,322	142.00	2,202
(Cement Clay)	7,731.23	11,022	32,260.95	89,903	24,529.72	78,881
(Fireclay)	91,040.00	66,123	169,341.00	107,180	78,301.00	41,057
(White Clay—Ball Clay)	656.00	7,432	901.00	10,812	245.00	3,380
(Brick Pipe and Tile Clay)	65,421.25	33,547	122,336.00	178,651	56,914.75	145,104
Coal	1,171,623.64	5,734,353	1,149,100.70	5,907,162	22,522.94	172,809
Cobalt (Metallic By-Product Nickel Mining)	202.43	801,560	190.48	629,500	11.95	172,060
Copper (Metallic By-Product Nickel Mining)	939.04	998,400	713.16	632,400	225.88	366,000
Copper Ore and Concentrates	1,990.92	283,322	999.69	254,990	991.23	28,332
Cupreous Ore and Concentrates	428.13	52,643	428.13	52,643
Felspar	414.50	6,217	560.50	8,408	146.00	2,191
Glass Sand	172,963.14	*82,927	162,762.15	*127,877	10,200.99	44,950
Gypsum	166,769.78	515,256	131,634.16	386,438	35,085.62	128,818
Iron Ore (Pig Iron Recovered)	59,245.00	3,697,908	60,829.00	3,987,937	1,584.00	290,029
(Exported)	48,920,181.71	361,587,134	51,986,329.38	358,677,945	3,066,147.67	2,909,189
(Pellets)	2,283,818.42	23,421,906	2,577,325.56	25,332,185	293,507.14	1,910,279
Lead Ore and Concentrates	40.16	3,899	40.16	3,899
*Limestone	1,284,680.05	1,373,218	1,129,720.18	1,182,229	154,959.87	190,989
Lithium Ores (Petalite)	1,647.50	26,190	1,053.50	16,771	594.00	9,419
Magnesite	60.00	900	30.00	450	30.00	450
Manganese (Metallurgical Grade)	128,308.00	2,138,974	97,934.00	1,541,332	30,374.00	597,642
Mineral Beach Sands (Ilmenite)	690,495.07	7,940,866	496,994.66	5,936,710	193,500.41	2,004,156
(Monazite)	3,090.28	447,876	2,322.03	301,756	768.25	146,120
(Rutile)	218.75	29,008	3,317.45	345,185	3,098.70	316,177
(Leucoxene)	10,936.30	1,012,004	14,893.60	720,986	3,957.30	291,018
(Zircon)	30,775.31	926,866	61,607.49	1,608,754	30,832.18	681,888
(Xenotime)	56.00	73,921	6.00	6,604	50.00	67,317
Nickel Concentrates	297,952.21	91,900,900	231,640.71	81,114,200	66,311.50	10,786,700
Nickel Ore	82,219.17	2,998,040	72,668.90	3,379,497	9,550.27	381,457
Ochre (Red)	542.50	9,122	542.50	9,122
Peat	1,490.00	29,031	1,490.00	29,031
Petroleum (Crude Oil)	bbls 16,352,920.00	36,466,886	bbls 15,402,695.00	34,346,900	bbls - 950,225.00	- 2,119,986
(Natural Gas)	m.c.f. 1,221,221.00	158,759	m.c.f. 23,466,978.00	3,176,203	m.c.f. + 22,245,757.00	+ 3,017,444
(Condensate)	bbls 43,269.00	N.A.	bbls + 43,269.00	N.A.
Salt	Tons 2,370,378.00	7,622,123	Tons 2,182,824.00	6,247,617	Tons - 187,554.00	- 1,374,506
Semi Precious Stones	lbs 275,300.50	91,560	lbs 194,536.00	47,074	lbs - 80,764.50	- 44,486
Talc	Tons 28,617.00	747,281	Tons 25,602.00	N.A.	Tons - 3,015.00	- 747,281
Tanto/Columbite Ores and Concentrates	73.85	383,650	265.52	1,201,689	191.67	818,039
Tin Concentrates	848.29	1,794,081	2,005.25	4,284,086	1,156.96	2,490,005
Vermiculite	54.10	325	374.36	2,266	320.26	1,941
Total	633,961,984	632,311,490	- 1,650,494

TABLE 1 (b)
Quantity and Value of Gold and Silver Exported and Minted during Years 1971 and 1972

Mineral	1971		1972		Increase or Decrease for Year Compared with 1971	
	Quantity	Value	Quantity	Value	Quantity	Value
Gold (Exported and Minted)	Fine oz. 348,009.32	\$A †11,921,570	Fine Oz. 348,851.74	\$A 16,042,688	Fine Oz. + 842.42	\$A + 4,121,118
Silver (Exported and Minted)	445,850.72	635,509	133,320.50	190,066	- 312,530.22	- 445,443
Total	12,557,079	16,232,754	+ 3,675,675
Grand Total	646,519,063	648,544,244	+ 2,025,181

* Incomplete. † Including Overseas Gold Sales Premium.

TABLE 2
ROYALTIES

Mineral	Royalty Collected		Increase or Decrease Compared with 1971
	1971	1972	
Alumina	\$ 339,045.90	\$ 388,480.41	+ 49,434.51
Amethyst	1.77	13.96	+ 12.19
Asbestos	7.59	- 7.59
Bentonite	1.00	.60	- .40
Beryl	115.00	22.40	- 92.60
Building Stone	1,087.69	528.23	- 559.46
Chalcedony	28.26	67.22	+ 38.96
Chrysoprase	329.88	75.79	- 254.09
Clay	5,376.34	9,755.30	+ 4,378.96
Coal	30,562.04	27,907.25	- 2,654.79
Cobalt	460.34	622.42	+ 162.08
Dravite	17.50	- 17.50
Felspar	19.25	24.36	+ 5.11
Glass Sand	8,774.59	5,651.30	- 3,123.29
Gypsum	7,027.92	7,296.56	+ 268.64
Ilmenite	45,760.36	53,982.50	+ 8,222.14
Iron Ore	21,497,907.05	21,984,724.69	+ 486,817.64
Leucosene	297.02	1,839.66	+ 1,542.64
Limestone	22,910.63	27,401.11	+ 4,490.48
Magnesite	3.00	16.50	+ 13.50
Manganese	22,992.22	17,030.70	- 5,961.52
Monazite	2,231.86	947.97	- 1,283.89
Moss Agate	18.00	+ 18.00
Moss Opal	63.75	40.86	- 22.89
Natural Gas	2,670.53	150,327.14	+ 147,656.61
Natural Gas Condensate	2,145.65	+ 2,145.65
Nickel	628,128.65	581,762.19	- 46,366.46
Ochre	27.12	+ 27.12
Oil (Crude)	1,784,216.59	1,452,401.99	- 331,814.60
Petalite	123.40	131.10	+ 7.70
Quartz Chrystal	15.96	+ 15.96
Rutile	32.74	167.62	+ 134.88
Salt	117,019.12	121,391.23	+ 4,372.11
Talc	2,499.29	2,774.35	+ 275.06
Tanto Columbite	2,564.73	5,469.27	+ 2,904.54
Tin	165.27	361.11	+ 195.84
Tourmaline	8.25	+ 8.25
Vermiculite	2.70	8.41	+ 5.71
Xenotime	167.05	- 167.05
Zircon	2,425.31	3,924.73	+ 1,499.42
	24,525,036.34	24,847,363.91	+ 322,327.57

TABLE 3

Showing for every Goldfield the amount of Gold reported to the Mines Department as required by the Regulations, also the percentage for the several Goldfields of the total reported (and the average value of the yield in pennyweights per ton of ore treated).

Goldfield	Reported Yield		Percentage for each Goldfield		† Average Yield per ton of ore treated	
	1971	1972	1971	1972	1971*	1972*
	Fine Ozs.	Fine Ozs.	Per cent.	Per cent.	Dwts.	Dwts.
1. Kimberley
2. West Kimberley
3. Pilbara	306	1,254	.089	.37	9.281	14.274
4. West Pilbara	45013
5. Ashburton
6. Gaseoyne	4401	4.335
7. Peak Hill	20	48	.006	.01
8. East Murchison	36	118	.010	.04	3.855	8.806
9. Murchison	14,610	25,557	4.233	7.59	4.568	6.517
10. Yalgoo	17	59	.005	.02	4.519	3.676
11. Mt. Margaret	739	1,232	.214	.37	14.812	8.241
12. North Coolgardie	110	990	.032	.29	2.537	10.927
13. Broad Arrow	277	441	.080	.13	1.996	1.603
14. North-East Coolgardie	307	243	.089	.07	1.635	3.373
15. East Coolgardie	276,410	256,143	80.096	76.04	3.792	3.685
16. Coolgardie	451	2,172	.131	.64	14.679	6.552
17. Yilgarn	1,880	1,341	.545	.40	9.698	5.406
18. Dundas	49,160	47,148	14.245	14.00	6.977	6.470
19. Phillips River	730	81	.212	.02	17.419
20. South-West Mineral Field
21. State Generally
	345,098	336,871	100.00	100.00	4.116	4.096

* Gold at \$31.25 per fine oz. or \$1.5625 per pennyweight.
† Includes by-product of Copper Mining.
‡ Averages exclude alluvial and dollied gold.

TABLE 4

The Output of Gold from the Commonwealth of Australia during 1972

State	Output of Gold	Value*†	Percentage of Total
Western Australia	348,852	10,901,625	47.01
Northern Territory	257,803	8,056,344	34.74
Queensland	61,501	1,921,906	8.28
Tasmania	57,264	1,789,500	7.72
New South Wales	10,754	336,062	1.45
Victoria	5,925	185,156	.80
South Australia	N.A.	N.A.	N.A.
Total	742,099	23,190,593	100.00

* \$31.25 per fine ounce.

† Exclusive of Overseas Gold Sales Premium by Gold Producers' Association

TABLE 5

Total Coal output from Collie River Mineral Field, 1971 and 1972, estimated Value therefrom, Average Number of Men Employed and Output per Man.

Year	Total Output	Estimated Value	Men Employed			Output per Man Employed		
			Above Ground	Under Ground	Open Cuts	In Open Cuts	Under Ground	Above and Under Ground
Deep Mining—	Tons	\$A	No.	No.	No.	Tons	Tons	Tons
1971	408,380	2,874,291	97	317	1,288	986
1972	415,898	3,112,225	99	311	1,337	1,014
Open Cut Mining—								
1971	763,244	2,860,062	209	3,652
1972	733,203	2,794,937	207	3,542
Totals—								In all Mines
1971	1,171,624	5,734,353	97	317	209	1,881
1972	1,149,101	5,907,162	99	311	207	1,862

DIAGRAM OF GOLD OUTPUT

SHOWING TONNAGES TREATED AS REPORTED TO MINES DEPT. THE TOTAL OUTPUT OF GOLD BULLION CONCENTRATES ETC. ENTERED FOR EXPORT AND RECEIVED AT THE PERTH MINT AND THE ESTIMATED VALUE THEREOF IN AUSTRALIAN CURRENCY

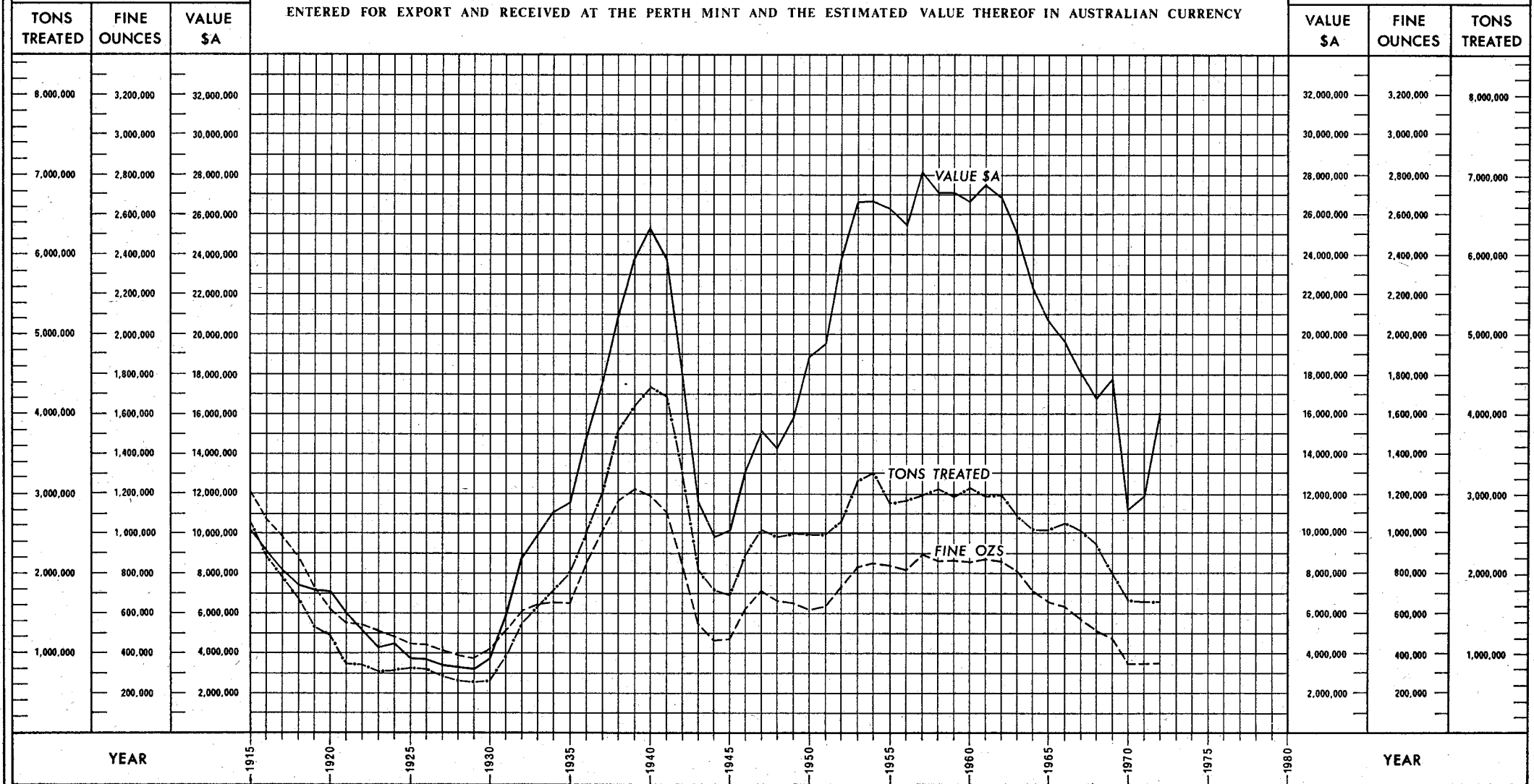

GRAPH OF COAL OUTPUT

SHOWING QUANTITIES AND VALUES AS REPORTED TO MINES DEPARTMENT

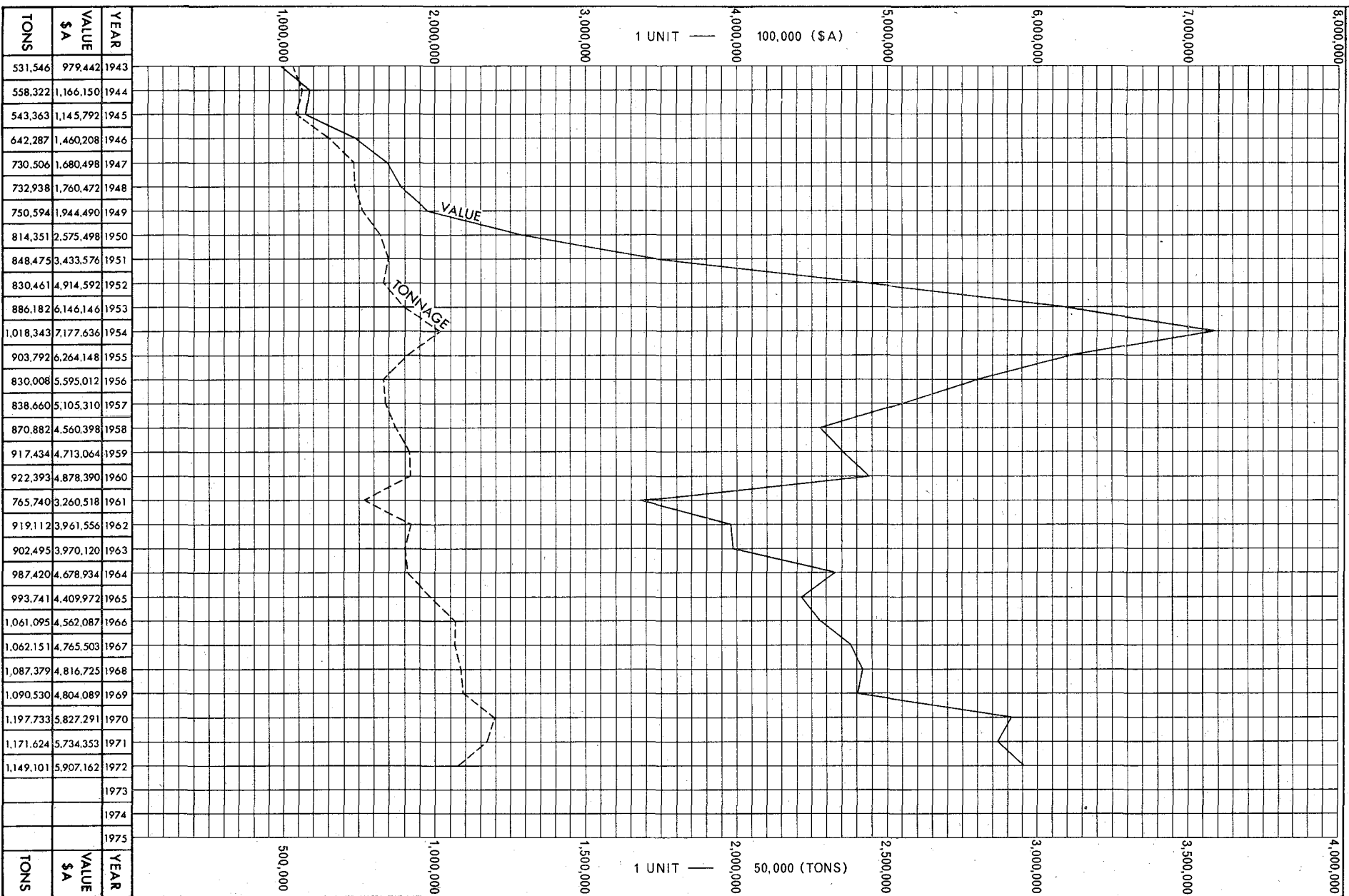

GRAPH OF TREND IN COAL OUTPUT
 SHOWING COMPARISON OF ANNUAL TONNAGE AND PERCENTAGES
 BETWEEN DEEP AND OPEN CUT MINING

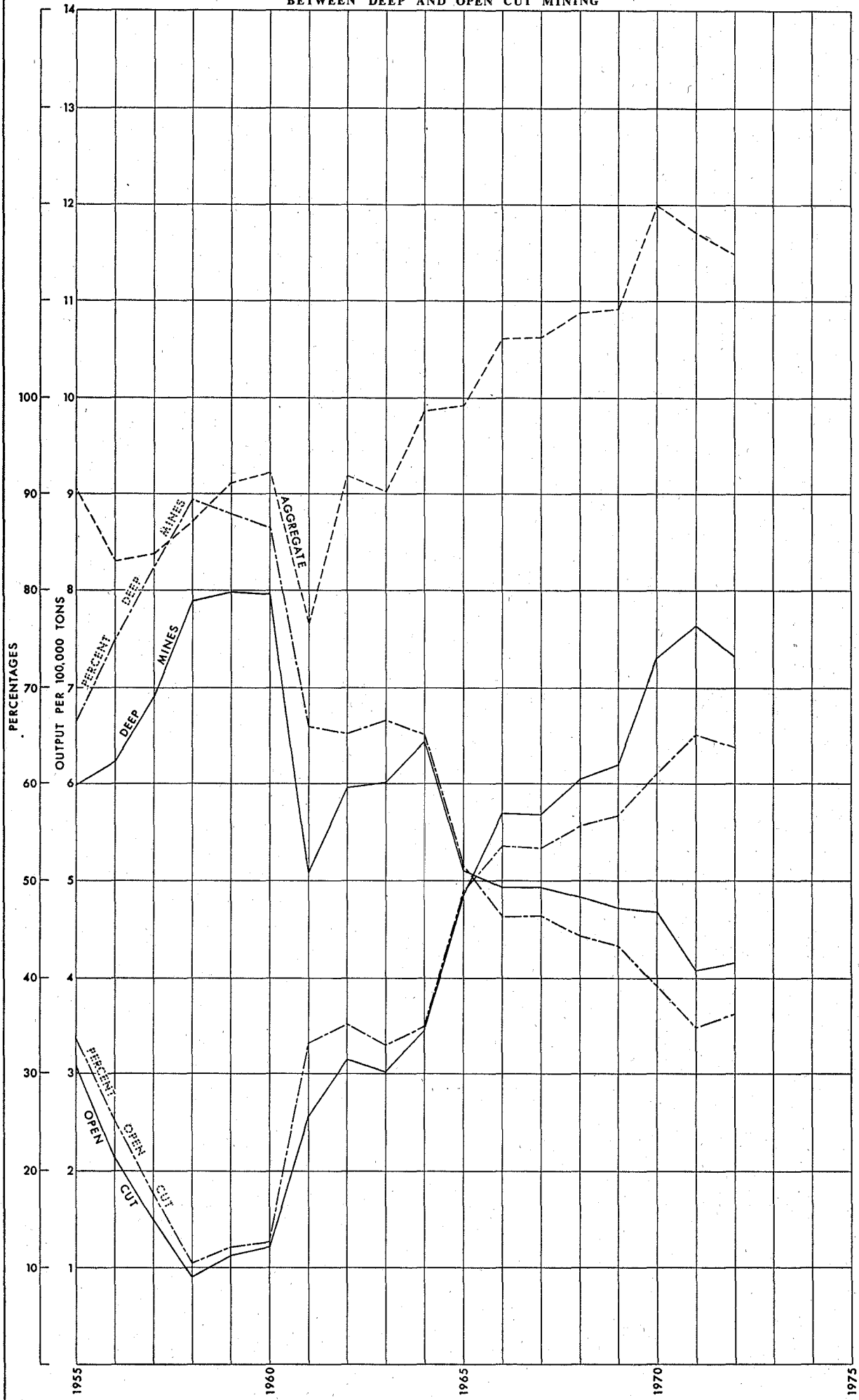

TABLE 6

MINING ACT, 1904.

LEASES AND OTHER HOLDINGS UNDER VARIOUS ACTS RELATING TO MINING.

Total Number and Acreage of Mining Tenements applied for during 1972 and in force as at 31st December, 1972 (compared with 1971)

	Applied for				In Force			
	1971		1972		1971		1972	
	No.	Acres	No.	Acres	No.	Acres	No.	Acres
Gold—								
Gold Mining Leases	130	5,411	707	15,148	1,370	26,022	1,410	27,154
Dredging Claims	9	2,203	2	600	10	1,878
Prospecting Areas	236	4,286	625	12,177	149	2,801	306	5,744
Temporary Reserves	42	11,083	1	188
Totals	366	9,697	1,341	29,528	1,563	40,506	1,727	34,964
Coal—								
Coal Mining Leases	1,254	363,767	168	53,456	52	15,016	62	17,325
Prospecting Areas	401	1,060,529	21	58,302	15	43,920
Temporary Reserves	8	550,592	1	49,421	2	4,320	3	53,741
Totals	1,663	1,974,888	190	161,179	69	63,256	65	71,066
Other Minerals—								
Mineral Leases	234	65,282	47	10,900	347	59,731	412	77,312
Dredging Claims	305	85,858	46	8,803	411	38,093	342	34,785
Mineral Claims	14,394	3,902,212	11,270	3,168,421	27,795	7,593,074	15,286	4,082,159
Prospecting Areas	44	958	55	1,750	34	751	32	697
Temporary Reserves	31	5,773,210	169	4,742,202	534	30,115,538	518	19,607,429
Totals	15,008	9,827,520	11,587	7,932,076	29,121	37,807,187	16,590	23,752,382
Other Holdings—								
Miner's Homestead Leases	2	29	334	33,373	324	32,631
Miscellaneous Leases	20	17,430	20	17,907	104	1,817	177	19,199
Residence Areas	2	2	62	51	58	48
Business Areas	5	5	28	24	26	22
Machinery Areas	21	57	21	56
Tailings Areas	24	89	21	79
Garden Areas	2	6	3	21	70	245	67	240
Quarrying Areas	58	1,170	38	674	87	1,701	125	2,524
Water Rights	7	1,489	7	158	125	2,781	105	2,054
Licenses to Treat Tailings	38	214	54	43
Totals	132	20,102	284	18,789	909	40,138	967	56,853
Grand Totals	17,169	11,832,207	13,402	8,141,572	31,662	37,951,087	19,349	23,915,265

TABLE 6 (a)

SPECIAL ACTS

Leases applied for during 1972 and in force at 31st December, 1972 (Compared with 1971)

Mineral	Applied for				In Force			
	1971		1972		1971		1972	
	No.	Acres	No.	Acres	No.	Acres	No.	Acres
Bauxite	7	3,137,280	7	3,137,280
Iron	1	161,426	2	43,245	5	451,106	6	612,478
Salt	1	3,410	2	593,430	3	596,430
Totals	1	161,426	3	46,655	14	4,181,816	16	4,346,188

TABLE 6 (b)
PETROLEUM ACTS

Permits, Licences and Leases applied for during 1972 and in force as at 31st December, 1972 (Compared with 1971)

Holding	Applied for				In Force			
	1971		1972		1971		1972	
	No.	Blocks	No.	Blocks	No.	Blocks	No.	Blocks
Onshore—								
Petroleum Act, 1967—								
Exploration Permits	5	393	11	2,164	53	6,510	63	8,036
Production Licences	3	14	3	14	3	14
Petroleum Lease (Barrow Island)	1	8	1	8
Totals	8	407	11	2,164	57	6,532	67	8,058
Petroleum Pipelines Act, 1969—								
Pipeline Licences	2	(44.26 miles)	2	(2.48 miles)	3	(272.38 miles)	5	(276.41 miles)
Totals	2	(44.26 miles)	2	(2.48 miles)	3	(272.38 miles)	5	(276.41 miles)
Offshore—								
Petroleum (Submerged Lands) Act, 1969:								
Exploration Permits	11	2,868	3	1,200	34	8,727	39	10,171
Production Licences
Petroleum Lease (Barrow Marine)	1	12	1	12
Totals	11	2,868	3	1,200	35	8,739	40	10,183
Grand Totals	19	3,275	14	3,364	92	15,271	107	18,241

(A block contains approximately 30 sq. miles and the numbers given above include part blocks.)

TABLE 6 (c)
MINING ACT, 1904

Leases in Force at 31st December, 1972 in each Goldfield, Mineral Field or District

Goldfield, Mineral Field, or District	Gold Mining Leases		Mineral Leases		Miner's Homestead Leases		Miscellaneous Leases	
	No.	Acres	No.	Acres	No.	Acres	No.	Acres
Ashburton	6	112
Black Range	5	71
Broad Arrow	30	478	2	562
Bulong	11	210
Collie	58	16,790
(Private Property)	2	520
Coolgardie	88	1,673	214	59,235	22	1,859	6	60
Cue	12	254	3	508	4	1,113
Day Dawn	20	386	8	1,247	1	20
Dundas	418	9,261	19	935
East Coolgardie	316	5,616	1	71	51	3,265	63	1,172
Gascoyne	10	218	6	287
Greenbushes	65	8,951	11	588
Kanowna	13	231	12	702
Kimberley	1	24
Kunanalling	7	131	2	520
Kurnalpi	2	48
Lawlers	17	326	5	1,110
Marble Bar	85	1,362	3	144	14	212
Meekeatharra	22	386	10	1,856	1	1
Menzies	28	582	7	740	1	10
Mount Magnet	78	1,283	4	38	1	10
Mount Malcolm	23	406	11	91
Mount Margaret	4	88	6	56
Mount Morgans	3	57
Niagara	2	29	1	120
Northampton	7	366
(Private Property)	2	33
Nullagine	27	452	2	22	2	48
Peak Hill	4	78	13	461	5	250	1	15
Phillips River	3	30	13	295	106	14,495
(Private Property)	1	297
South-West	3	72	2	63	3	16
(Private Property)	13	3,102
Ularring	25	482	1	20
West Kimberley	23	755	5	75
West Pilbara	16	368	16	322	3	35	11	215
Wiluna	4	92	6	334	17	3,879	3	11
Yalgoo	14	259	2	33	1	10
Yerilla	25	520	1	10
Yilgarn	81	1,435	2	96	25	925	6	51
(Private Property)	13	246
Outside Proclaimed
Totals	1,410	27,154	412	77,312	324	32,631	177	19,199

Gold Mining Leases on Crown Land	1,397	26,908 acres
Gold Mining Leases on Private Property	13	246 "
Mineral Leases on Crown Land	396	73,880 "
Mineral Leases on Private Property	16	3,432 "
Miner's Homestead Leases on Crown Land	324	32,631 "
Other Leases on Crown Land	175	18,679 "
Other Leases on Private Property	2	520 "

TABLE 6 (d)
MINING ACT, 1904

Claims and Authorised Holdings in Force at 31st December, 1972 in each Goldfield, Mineral Field or District

Goldfield, Mineral Field or District	Prospecting Areas		Dredging Claims		Mineral Claims		Residence Areas		Business Areas		Machinery Areas		Tailings Areas		Garden Areas		Quarrying Areas		Water Rights			
	Number	Acres	Number	Acres	Number	Acres	Number	Acres	Number	Acres	Number	Acres	Number	Acres	Number	Acres	Number	Acres	Number	Acres		
Ashburton	2	48			342	94,015												2	48			
Black Range	9	216			146	39,405	4	1														
Broad Arrow	26	474			357	93,522	1	1	1	1										3	8	
Bulong	18	336			275	79,831																
Collie																						
(Private Property)																						
Coolgardie	39	658			1,218	320,811	3	3			1	1			4	11	19	424	6	49		
Cue	14	251			504	131,426	2	1												1	3	
Day Dawn					39	10,344									4	20						
Dundas	18	356			532	132,446																
East Coolgardie	33	594			370	99,094	33	33			1	2	10	46	10	44	4	4	60	2	12	
Gascoyne	1	24	2	409	247	48,182														11	32	
Greenbushes					1	20	1	1												7		
Kanowna	16	297			404	112,841									9	37				2	34	
Kimberley	4	63			361	96,265														1	1	
Kunanalling	5	120			209	60,190									1	2	4	68				
Kurnalpi	5	108			310	88,618														2	24	
Lawlers	2	48			758	218,705					2	6	1	5								
Marble Bar	14	215	312	27,863	1,442	350,279			3	3	5	13			13	48	17	293	1	1		
Meekatharra	6	119			556	162,383														23	415	
Menzies	7	125			324	81,178														1	4	
Mount Magnet	9	188			216	59,437	1	1												4	10	
Mount Malcolm	11	228			253	74,256									8	7				3	4	
Mount Margaret	2	48			635	185,558									6	21				3	4	
Mount Morgans	4	82			658	191,658														3	3	
Niagara	4	72			75	22,042														3	6	
Northampton	5	100			49	8,897																
(Private Property)					8	451																
Nullagine	12	276	10	1,878	458	115,086					2	2	3	4	2	5				12	34	
Peak Hill	4	58			195	45,842			2	2	2	8	1	5						1	10	
Phillips River	4	69	16	4,721	174	32,214					1	2	1	2						6	144	
(Private Property)					73	20,365														2	2	
South West	1	24	8	1,517	255	31,184																
(Private Property)			1	223	290	55,101																
Ularring	9	180			130	38,292					1	1	2	4								
West Kimberley	1	24			64	16,418					2	10								18	280	
West Pilbara	7	168	3	52	854	226,334	4	4	13	13					5	33	40	954	9	39		
Wiluna	1	24			1,045	303,749					1	1	1	3						1	1,320	
Yalgoo	10	232			515	135,097			6	2	1	5	1	5						2	29	
Yerilla	9	156			220	60,956														1	10	
Yilgarn	30	511			572	146,197	9	3	1	1	2	5			4	9	1	24		5	12	
(Private Property)					83	23,022																
Outside Proclaimed					69	20,448																
Totals	342	6,492	352	36,663	15,286	4,032,159	58	48	26	22	21	56	21	79	67	240	125	2,524	105	2,054		

TABLE 7

MEN EMPLOYED

Average number of Men employed in Mining during 1971 and 1972

Goldfield	District	Gold		Other Minerals		Total	
		1971	1972	1971	1972	1971	1972
Kimberley							
West Kimberley				339	298	339	298
Pilbara	Marble Bar	3	18	540	530	543	548
	Nullagine	8	1	18	8	26	9
West Pilbara		2		977	1,178	979	1,178
Ashburton				305	306	305	306
Gascoyne			2	2	6	2	8
Peak Hill		2	2	867	826	869	828
East Murchison	Lawlers	6	2			6	2
	Wiluna						
Murchison	Black Range	2	2			2	2
	Cue	1				1	
	Meekatharra	2	13			2	13
	Day Dawn		2				2
Yalgoo	Mt. Magnet	116	113			116	113
		2	7	5	2	7	9
Mt. Margaret	Mt. Morgans	2				2	
	Mt. Malcolm	2	23			2	23
North Coolgardie	Mt. Margaret						
	Menzies	2	9			2	9
	Ularring	1	2			1	2
	Niagara		2				2
Broad Arrow	Yerilla	1	3			1	3
		5	20	412	331	417	351
North-East Coolgardie		4	9			4	9
East Coolgardie	Kanowna						
	Kurnalpi						
Coolgardie	East Coolgardie	1,372	1,421			1,372	1,421
	Bulong	2	2			2	2
Coolgardie	Coolgardie	4	45	1,475	1,484	1,479	1,529
	Kunanalling		11				11
Yilgarn		9	36	100	94	109	130
Dundas		227	230	4	4	231	234
Phillips River			2				2
South-West Mineral Field				1,945	2,160	1,945	2,160
Northampton Mineral Field				2		2	
Greenbushes Mineral Field				103	109	103	109
Outside Proclaimed Goldfield				10	12	10	12
Collie Coalfield				623	617	623	617
Total—All Minerals				1,775	1,982	7,727	7,965

	1971	1972
Minerals Other than Gold—		
Alumina (from Bauxite)	1,374	1,671
Beryl	2	2
Building Stone	12	7
Clays	12	11
Coal	623	617
Copper	20	22
Cupreous Ore (Fertiliser)	20	
Felspar	11	11
Glass Sand	7	8
Gypsum	5	5
Iron Ore	2,754	2,826
Lead	2	
Limestone	22	22
Manganese	24	8
Mineral Beach Sands	399	334
Nickel	1,861	1,804
Peat	2	
Petroleum (Crude Oil)	106	133
(Natural Gas)	14	8
Salt	259	290
Semi-precious Stones	16	20
Talc	13	10
Tanto Columbite	3	
Tin	164	154
Vermiculite	2	2
Total, Other Minerals	7,727	7,965

PART 3—STATE AID TO MINING

(a) State Batteries

At the end of the year there were 17 State Batteries including the Northampton Base Metal Plant.

From Inception to the end of 1972, gold, silver, tin, tungsten, lead, copper and tantalite ores to the value of \$41,901,611 have been treated at the State Batteries. Included in the above amount is \$16,579,509 gold premium and \$392,351 premium paid by sales of gold by the Gold Producers Association Ltd. \$39,866,146 came from 3,700,708½ tons of gold ore, \$473,934 from 84,019 tons of tin ore, \$40,266 from 4,196½ tons of tungsten ore, \$1,432,034 from 65,223 tons of lead ore, \$11,932 from 220½ tons of copper ore and \$73,121 from 2,158½ tons of tantalite ore, and silver valued at \$4,178 recovered as a by-product from the cyaniding of Gold Tailings.

During the year 44,135½ tons of gold ores were crushed for 13,434½ oz. bullion, estimated to contain 11,385½ oz. fine gold equal to 5 dwt. 4 grn. per ton. The average value of sands after amalgamation was 1 dwt. 21 grn. per ton, making the average head value 7 dwt. per ton. Cyanide plants produced 1,556½ oz. fine gold, giving a total estimated production for the year of 12,542½ oz. fine gold valued at \$586,032.

The working expenditure for the year for all plants was \$633,478 and the revenue was \$68,777 giving a working loss of \$564,700 which does not include depreciation, interest or superannuation. Since the inception of State Batteries, the Capital expenditure has been \$1,898,052 made up of \$1,471,570 from General Loan Funds; \$341,666 from Consolidated Revenue; \$57,244 from Assistance to Gold Mining Industry; and \$27,572 from Assistance to Metalliferous Mining.

Head Office expenditure including workers compensation insurance and pay roll tax was \$89,113 compared with \$27,668 for 1971.

The actual expenditure from inception to the end of 1972 exceeds revenue by \$7,599,005.

(b) Prospecting Scheme

At the end of the year 13 men were in receipt of prospecting assistance as compared with 19 at the end of 1971.

Total expenditure for 1972 was \$11,716.00 and refunds amounted to \$1,661.00.

Assisted prospectors crushed 761 tons of ore during the year for 159 oz. of gold.

Progressive total figures since the inception of the scheme are:—

Expenditure—\$1,038,632.

Refunds—\$202,075.

Ore crushed—126,454 tons.

Gold won—58,151 oz.

The rate of assistance remained at \$17.50 per man per week in the more remote localities and \$15.00 per man per week in the less isolated areas.

(c) Geological Survey of Western Australia

Once again great demands on the services of the Geological Survey were made in providing regional geology, specialists services and information from the Survey's library and other records.

The scope of the advice and information available from the Branch is well known and its officers provide advice to the mining and allied industries where required, and advise on exploration and development of mineral production and water supplies.

PART 4—GOVERNMENT CHEMICAL LABORATORIES

This Branch has wide functions serving both governmental and private sectors of the community as the names of the Divisions indicate:—

- (1) Agriculture Division.
- (2) Engineering Chemistry Division.
- (3) Foods, Drugs, Toxicology and Industrial Hygiene Division.

- (4) Industrial Chemistry Division.
- (5) Mineralogy, Mineral Technology and Geochemistry Division.
- (6) Water Division.
- (7) Kalgoorlie Metallurgical Laboratory.

Various members of the staff are members of fourteen Boards or Committees.

This Branch suffered a fire in its buildings on 8th January, 1972, and considerable damage was done to buildings and equipment. The loss, based on cost of rebuilding and the replacement of equipment, was estimated at \$500,000. Despite this severe handicap the Branch performed satisfactorily and dealt with 2,459 more samples in 1972 than in 1971.

PART 5—EXPLOSIVES BRANCH

The function of the Explosives Branch are to ensure that the quality of explosives and the modes of transport and storage of explosives and flammable liquids comply with State requirements.

During the year Inspectors found it necessary to confiscate and destroy a total of 4,190 lbs. of explosives and 1,400 detonators due to deterioration.

At the end of the year there were 533 licences current in respect of explosives and about 5000 in respect of flammable liquids.

PART 6—MINE WORKERS' RELIEF ACT AND MINERS' PHTHISIS ACT

Under arrangement with this Department the State Public Health Department continued the periodical X-Ray examination of mine workers throughout the year.

A total of 9,665 examinations were made of which 4,982 were made under the Mine Workers' Relief Act and 4,683 under the Mines Regulations Act. Of the latter, 4,272 were new applicants and 411 were re-examinees.

Compensation payments under the Miners' Phthisis Act amounted to \$7,988 compared with \$9,712 for the previous year.

PART 7—SURVEYS AND MAPPING BRANCH

During the year 3,730 surveys of mining tenements were completed compared with 4,129 in 1971 and 15,700 applications for mining titles were received for processing.

During the year the services of six draftsmen were obtained on loan from the Lands Department to assist in the examination of the large number of accumulated surveys.

The Regulations for the Guidance of Surveyors were amended during the year to make the use of metric units a statutory requirement with effect from 1st September, 1972.

PART 8—STAFF

The upsurge in work within the Department as a result of the mineral boom experienced in 1971 and the immediately preceding years levelled off during 1972. This levelling off factor together with the introduction of new methods has been responsible for the Department being able to cope satisfactorily with the work situation.

Members of the staff both in Perth and the outstations are to be congratulated on the manner in which they carried out their duties during the year under review.

In this Division I have referred only to the main items of the Department's activities. Detailed reports relating to the activities of each Branch are contained in Divisions II to VIII.

G. H. COOPER,
Under Secretary for Mines.

Department of Mines,

Perth.

DIVISION II

Report of the State Mining Engineer for the Year 1972

Under Secretary for Mines:

I hereby submit the 1972 Annual Report for the State Mining Engineer's Branch, which is divided into the following sections—

Mineral and Metal Production—

by J. F. Haddow, Mining Engineer—District Inspector of Mines.

Mine Inspection and Accident Statistics—

by J. M. Faichney, Mining Engineer—Senior Inspector of Mines (Perth).

Petroleum Exploration and Production—

by A. J. Sharp, Senior Petroleum Engineer.

Coal Mining—

by R. S. Ferguson, Mining Engineer—Senior Inspector of Coal Mines.

Drilling Operations—

by D. A. Macpherson, Drilling Engineer.

Board of Examiners—

by W. J. Cahill, Secretary, Board of Examiners.

MINERALS METALS AND OIL

In Western Australia's mineral, metal and oil production the value of iron ore production was again the highest for the 1972 year at \$384,010,130 followed by alumina at \$90,443,400, nickel ore and concentrates at \$84,493,697 and crude oil at \$34,346,900.

Of the main iron ore companies, Hamersley Iron Pty. Ltd. reported exports of approximately 21.4 million tons at a grade of 64.46 per cent Fe; Mt. Newman Mining Co. Pty. Ltd. 18.96 million tons at approximately 63 per cent Fe and Goldsworthy Mining Ltd. 6.15 million tons at a grade of 63.87 per cent Fe.

Barrow Island oilfield production throughout the year was slightly lower at 42,000 bbls per day compared with the average rate of 44,000 bbls per day in 1971.

Natural gas production from the Dongara and Mondarra gas fields increased from 33 million cubic feet per day in January 1972 to 81 million cubic feet per day in December, 1972.

Land exploration drilling activity increased from 23 rig months in 1971 to nearly 26 rig months in 1972. Offshore exploration drilling activity at 37 rig months remained at about the same level as in 1971.

DRILLING

During 1972 the Drilling Section was responsible for the drilling of 9,857 metres (32,331 feet) in 298 bores and the testing by pumping of five bores.

Drilling to provide information on foundation conditions was completed in the Bunbury Harbour, and programmes for the purpose of testing the suitability of several damsites for Pilbara water supply purposes, were carried out at Cooya Pooya on the Harding River, Kangan Pool on the Sherlock River and at Bullinarwa on the Fortescue River.

A lignite investigation drilling programme was carried out in the Fitzgerald River flora and fauna reserve. A programme was also carried out for the purpose of obtaining information on rock conditions at the portals and mid point of the Roleystone tunnel. This information was required by the Metropolitan Water Supply Board for reticulation purposes and was carried out by contractors supervised by Drilling Section operators.

The remainder of the drilling operations carried out by the Drilling Section formed part of the State wide ground water investigation and these were carried out at Watheroo, Eneabba, Gnangara and Joondalup in the South West, and at Millstream, Cooya Pooya, Port Hedland and the Canning Basin in the North West.

STAFF

Appointments—

A. W. Ibbotson, Mining Engineer— District Inspector of Mines	24/7/72
G. R. Guthrie, Mining Engineer— Special Inspector of Mines	6/11/72
B. J. D. Van der Hoek, Mining Engineer—District Inspector of Mines	10/7/72
D. E. Johnson, Ventilation Officer		7/2/72
A. N. Thompson—General Assistant		25/9/72

A. Y. WILSON,
State Mining Engineer.

TABLE 1
Mineral and Metal Output

Product	1971		1972	
	Tons	Value	Tons	Value
		\$A		\$A
Alumina	1,255,209.00	80,333,200	1,413,182.00	90,443,400
Asbestos	50.60	2,125
Bentonite	20.00	120	162.00	2,322
Beryl	63.42	17,703	61.49	12,870
Building Stone	11,920.00	142,728	5,232.50	52,079
Clays	164,848.48	118,124	324,838.95	386,546
Coal	1,171,623.64	5,734,353	1,149,100.70	5,907,162
Cobalt	202.43	801,560	190.48	629,500
Copper—				
Ore and Concentrates	1,990.92	283,322	999.69	254,990
Fertilizer Grade	428.13	52,643
Metal	939.04	998,400	713.16	632,400
Felspar	414.50	6,218	560.50	8,408
Glass Sand	172,963.14	82,927	162,762.15	127,877
Gold (fine ounces)	345,098.34	12,091,687	336,869.00	15,256,797
Gypsum	166,769.78	515,256	131,684.16	386,438
Ilmenite	690,495.07	7,940,866	496,994.66	5,936,710
Iron Ore	51,204,000.13	385,009,040	54,563,654.94	384,010,130
Iron Ore—Pig Iron	93,774.00	3,697,908	98,113.00	3,987,937
Lead Ore and Concentrates	40.16	3,899
Leucoxene	10,936.30	1,012,004	14,893.60	720,986
Limestone	1,284,680.05	1,373,218	1,129,720.18	1,182,229
Lithium Ore—Petalite	1,647.50	26,190	1,053.50	16,771
Magnesite	60.00	900	30.00	450
Manganese	128,308.00	2,138,974	97,934.00	1,541,332
Monazite	3,090.28	447,876	2,332.03	301,756
Nickel Ore and Concentrates	380,171.38	94,898,940	304,309.61	84,493,697
Ochre	542.50	9,122
Petroleum—				
Crude oil (barrels)	16,352,920.00	36,466,886	15,402,695.00	34,346,900
Natural Gas (1,000 cu. ft.)	1,221,221.00	158,759	23,466,978.00	3,176,203
Condensate (bbls.)	43,629.00	Not avail.
Rutile	218.75	29,008	3,317.45	345,185
Salt	2,370,378.00	7,622,123	2,182,824.00	6,247,617
Semi-precious Stones	123.79	91,560	86.85	47,074
Silver (fine ounces)	445,850.72	635,509	133,320.50	190,066
Talc	28,617.00	747,281	25,602.00	Not avail.
Tantalo-Columbite	73.85	383,650	265.52	1,201,689
Tin Concentrate	848.29	1,794,081	2,005.25	4,284,086
Vermiculite	54.10	325	374.36	2,266
Xenotime	56.00	73,921	6.00	6,604
Zircon	30,775.31	926,866	61,607.49	1,608,754
Totals	646,660,150	647,758,353

TABLE 2
Development Footages Reported by the Principal Mines

Gold or Mineral Field	Mine	Decline and Shaft Sinking	Driving	Cross Cutting	Rising and Winzing	Exploratory Drilling	Total
		feet	feet	feet	feet	feet	feet
Gold—							
Murchison	Hill 50 Gold Mine N.L.	159	196	141	4,684	5,180
Dundas	Central Norseman Gold Corpn. N.L.	198	527	1,053	16,155	17,933
East Coolgardie	Gold Mines of Kalgoorlie (Aust.) Ltd.	615	9,223	2,060	13,923	25,821
	Lake View and Star Ltd.	2,364	859	661	8,248	12,132
	North Kalgurli Mines Ltd.	1,708	155	367	5,781	8,011
	Totals in Gold Mines	615	13,652	1,737	4,282	48,791	69,077
Nickel—							
Coolgardie	Western Mining Corpn. Ltd.	10,570	25,144	8,841	241,312	285,867
	Metals Exploration N.L.	1,723	3,676	1,877	4,393	15,570	27,239
	International Nickel Aust. Ltd.	991	219	63	11,863	13,136
	Anaconda Australia Inc.	137	76	213
	Selcast	1,416	247	254	2,707	4,624
Broad Arrow	Scotia (Great Boulder-North Kalgurli)	181	1,576	676	592	2,336	5,361
North Coolgardie	Carr Boyd Rocks (Great Boulder-North Kalgurli)	216	14	23	19	138	410
Mt Margaret	Poseidon Ltd.	3,099	521	4,487	8,107
	Totals in Nickel Mines	17,342	31,401	3,042	14,759	278,413	344,957

MINERAL AND METAL PRODUCTION

J. F. Haddow—Mining Engineer—District Inspector of Mines

Mineral production for the year 1972 described in this report is based on information obtained from various sources including the Statistical and Mines Inspection Sections of the Mines Department.

Tonnage figures quoted represent production from companies during the year and not necessarily sales.

Statistics relating to the mining industry are tabulated as follows:—

- Table 1—Mineral and Metal Output.
- Table 2—Development Footages.
- Table 3—Principal Gold Producers.
- Table 4—Iron Ore Exported Overseas.

ALUMINA

The world marketing situation was cited as the reason for a deferment of further work by Amax Bauxite Corporation on the Mitchell Plateau Project, which was agreed to in 1972.

At Jarrahdale, Alcoa of Australia (W.A.) Limited produced 4,318,323 tons of bauxite which was railed to the Kwinana Alumina Refinery. Mining operations at Jarrahdale covered 120 acres with pit faces ranging from 10 to 20 feet.

Four new 100 tonne trucks were added to the haulage fleet, bringing to seven the number of these units on site. Further improvements were made to the land rehabilitation and reforestation of mined areas and a nursery was established at the old Jarrahdale No. 1 minesite. The company employed 1,342 personnel which included 165 at the minesite with the balance at the refinery.

Construction of the Pinjarra refinery and the Del Park mining complex was completed early in 1972. Mining at Del Park covered 30 acres with pit faces ranging from 10 to 20 feet. After commissioning, the mobile crusher, overland conveyors and stacker operated satisfactorily throughout the year. Alumina was first produced at the Pinjarra refinery in May 1972, with the produce being railed to Kwinana for shipping through the Kwinana refinery system. The company employed an average of 392 personnel, which includes 44 at the mine site.

BENTONITE

Production from deposits at Lake Marchagee was reported as 162 tons valued at \$2,322.00.

BERYL

Seleka Mining Investments Ltd. obtained 61.49 tons of Beryl containing 733.30 units of Be O from M.C. 874 in the Rothsay area. The beryl occurs in random pods throughout a pegmatite formation.

BUILDING STONE

Production from mining tenements, granted under the provisions of the Mining Act, was 5,232 tons valued at \$52,079.

The principal source of this production was at Mukinbudin where Snowstone Pty. Ltd. reported 3,781 tons of white quartz valued at \$37,810. Other building stone material produced included Toodyay stone, granite facing stone, and spongolite.

CLAYS

Reported clay production from pits within the Metropolitan area, Bullsbrook, Byford, and Armadale totalled approximately 325,000 tons at an estimated value of \$386,000.

COAL

Total output reported was 1,149,101 tons. This was 22,253 tons below last years figures.

COBALT

Production of cobalt, as a constituent mineral contained in nickel concentrates, was reported as being 145.48 tons valued at \$452,100, from Western Mining Corporation at Kambalda, and 45 tons valued at \$177,400 from Great Boulder Mines Limited and North Kalgurli Mines Limited operations at Scotia.

COPPER

Group Explorations Pty. Ltd. reported the production of 999.69 tons of copper concentrates containing 30,650.61 units of copper valued at \$254,990 from their operations at Ilgarari. The process utilised heavy media separation, with magnetite as the dense medium. Tailings from this plant were of the order of 12 per cent so a flotation plant was being installed to improve extraction.

W.M.C. Ltd. reported 713.16 tons of copper valued at \$632,400 contained in nickel concentrates produced at Kambalda.

No other cupreous ore production was reported during 1972 although several companies are actively engaged in field exploration for copper deposits.

FELSPAR

A.C.I. Raw Materials reported the production of 673 tons of Felspar from their quarry at Londonderry, south of Coolgardie.

GLASS SAND

Glass sand production totalled 162,762 tons valued at \$127,877 plus the value of sand exported by the Readymix Group (W.A.) which amounted to 1,031 tons but for which no valuation has been disclosed.

The principal suppliers of glass sand during 1972 were Silicon Quarries Pty. Ltd. at Jandakot with 142,117 tons and Australian Glass Manufacturers at Lake Gnangara with 12,861 tons.

TABLE 3
Principal Gold Producers

Mine	1971			1972		
	Tons Treated	Fine Ounces	Dwts. per ton	Tons Treated	Fine Ounces	Dwts. per ton
Gold Mines of Kalgoorlie	825,593	135,467	3.28	809,856	143,841	3.55
Lake View and Star Ltd.	387,244	92,299	4.77	397,496	81,600	4.10
North Kalgurli Mines Ltd.	234,701	44,227	3.77	158,753	26,475	3.33
Central Norseman Gold Corporation	140,634	48,959	6.96	145,484	47,082	6.47
Hill 50 Gold Mine N.L.	58,404	14,208	4.86	78,857	25,292	6.44
Minor Producers	28,533	9,938	6.96	54,431	11,779	4.26
State Total	1,675,109	345,098	4.12	1,644,877	336,869	4.10

GOLD

Gold Mines of Kalgoorlie (Aust) Ltd. headed the list of major gold producers during 1972 with a total of 809,856 tons treated from which 143,841 fine ounces of gold was recovered. 132,492 tons of ore containing 28,905 fine ounces of gold was mined from the Fimiston leases while 677,364 tons containing 114,936 fine ounces of gold came from the Mt. Charlotte leases.

Ore reserves at 20.672 were quoted as being:—

Fimiston Leases: 436,000 Tons at 4.4 dwt/ton.

Mt. Charlotte Leases: 1,861,000 Tons at 3.7 dwt/ton.

This company employed an average of 658 persons.

North Kalgurli Mines Ltd., had been preparing to cease gold mining at Fimiston but increases in the price of gold encouraged that company to re-commence active mine development. The year's production stands at 158,753 tons treated for a return of 26,475 fine ounces of gold.

An average of 280 persons were employed by this company.

Lake View and Star Ltd., produced 397,496 tons of ore from which 81,600 fine ounces of gold and 10,175 fine ounces of silver were recovered. This ore was mined from the Fimiston leases and 1,638 tons of tailings from Golden Ridge was also treated at Fimiston for an estimated additional recovery of 188 fine ounces of gold.

An average of 601 employees were engaged by Lake View and Star Ltd. during 1972.

Central Norseman Gold Corporation recovered 47,082 fine ounces of gold and 31,388 fine ounces of silver from the treatment of 145,484 tons of ore during 1972. All but 936 tons of the ore treated came from the Regent shaft area.

Ore reserves at June, 1972, were quoted at 161,280 tons of 7.55 dwt. ore.

An average of 237 persons were employed during 1972.

Hill 50 Gold Mine N.L. reported the production of 25,292 fine ounces of gold from the treatment of 78,857 tons of ore. The bulk of this ore came from the Hill 50 Main Shaft as the Morning Star shaft is limited to something like 1,000 tons per month output.

An average of 100 persons were employed by Hill 50 Gold Mine N.L.

The increased price being paid for gold has resulted in a renewal of underground development and exploratory drilling activities. Gold Mines of Kalgoorlie increased development footages from 7,834 feet in 1971 to 13,923 feet in 1972 and Diamond Drilling from 7,827 feet in 1971 to 13,923 feet in 1972.

North Kalgurli Mines Ltd., did no development during 1971 but completed 2,230 feet in 1972 and completed 5,781 feet of exploratory diamond drilling in 1972 compared with only 492 feet in 1971.

During 1972 Lake View and Star Limited reported 3,883 feet of underground development and 8,247 feet of diamond drilling.

At Norseman Central Norseman Gold Corporation reported a total of 1,778 feet of development as well as 11,166 feet of surface sited diamond drilling and 4,989 feet of underground diamond drilling.

Development at Hill 50 Gold Mine amounted to 496 feet plus 4,684 feet of completed exploratory Diamond Drilling.

Apart from the five principal gold producers there were numerous other gold producers around the State.

Amongst the more significant of these producers was the "Daisy" Gold Mine at Mt. Monger which reported the recovery of 1,180.55 fine ounces from 702 tons of ore. At the "Radio" Gold Mine—Bullfinch 2,367 tons of ore yielded 536 fine ounces of gold.

In the Meekatharra area some 3,700 tons of marginal material was carted to the State Battery from nearby open-cut operations. This operation utilised a bulldozer to excavate the material and took advantage of short haulage plus the availability of cheap crushing facilities at the otherwise idle State Battery. Gold recovered amounted to 225 fine ounces and was said to have covered all expenses incurred by the operator. The "Scheelite" Gold Mine at Barrambie treated 140 tons of ore at the Sandstone State Battery for a return of 117.45 fine ounces of gold.

At Marvel Loch the "Frances Firness" Gold Mine, 1,760 tons yielded 115 fine ounces of gold, while the "Mary Lena" Gold Mine produced 1,503 tons for a return of 184 fine ounces. The "Frasers" Gold Mine at Southern Cross was unwatered and a total of 1,290 tons of ore was taken to the battery at Marvel Loch for a return of 280 fine ounces plus 67 ounces of bullion.

GYPSUM

The reported production of Gypsum during 1972 was 131,684 tons valued at \$386,438.

Garrick Agnew Pty. Ltd. with 73,748 tons valued at \$258,118 from Shark Bay was the major producer.

Some 56,000 tons was obtained from Yellowdine and Lake Brown in the Yilgarn with something less than 2,000 tons being mined in the Yelbini and Nukarni areas of the south west.

ILMENITE, LEUCOXENE, MONAZITE, RUTILE, XENOTIME, ZIRCON

Sales of ilmenite totalled 496,995 tons at an estimated value of \$5,936,710. Minerals associated with ilmenite amounted to a further 82,147 tons which had an estimated value of \$2,983,285.

Western Titanium N.L., at Capel produced 271,582 tons of Ilmenite, 2,906 tons of Rutile, 942 tons of Leucoxene, 24,586 tons of Zircon and 4 tons of Xenotime. This production was obtained from the treatment of 1,827,025 tons of excavated material.

During 1972 Western Titanium N.L., carried out an intensive programme of rehabilitation and in addition to the seeding of mined areas with rye, couch and clover, planted several hundred trees and stocked permanent dams with Rainbow Trout fingerlings.

The company employed a total of 190 persons on this project at Capel.

Westralian Sands Ltd. Yoganup—During 1972 some 716,400 tons of material were treated at the Yoganup wet treatment plant, with the coarse mineral concentrates being road hauled to the Capel separation plant for further processing.

Yoganup Extended—A new operation was commenced on the north side of the Capel River on what would be the northern extension of the Yoganup mineral beds. Production during the last ten months of 1972 amounted to 925,142 tons of mineral bearing material which was treated at the Yoganup extended plant.

From the combined total of coarse concentrates brought into Capel from the two wet treatment plants the following quantities of minerals were recovered.

Ilmenite—140,565 tons

Zircon—22,827 tons

Leucoxene—6,032 tons

Monazite—649 tons

On the two mining operations 22 permanent and 14 contractors were employed while 54 persons were engaged in and around the separation plant with a further 29 persons comprising staff and laboratory technicians.

Western Minerals Sands Pty. Ltd. This company produced 179,378 tons of ilmenite and 29,492 tons of heavy mineral residues which were sold to Westralian Sands Ltd. The mineral recovered was reported to have been won from a total of 993,322 tons of mineral sands mined during 1972.

The company is planning to use a dredging type of operation in place of the mobile trommel/pump arrangement now in use. The deposit is quite suitable for dredging.

During 1972 an average of 36 employees were engaged with this company's operations.

Cable (1956) Ltd., in conjunction with Ilmenite Minerals Pty. Ltd., produced a total of 45,275 tons of ilmenite, 10,471 tons of leucosene, 3,529 tons of zircon and 413 tons of monazite from 734,800 yards of material mined at Stratham and Wonnerup.

The Stratham operations utilise a floating dredge and suction cutter extracting mineral bearing sands to depth of 14 feet with a labour force of 5 men.

The operation at Wonnerup is a simple dry mining process of digging and carting with a front-end loader, dumping into a hopper over a trommel and then sluicing the material into the trommel.

Coarse material goes to waste, while the sand and heavy minerals go into a sump from which they are pumped to a wet treatment plant for the recovery of the heavy mineral content.

The coarse concentrates are hauled to the north shore separation plant in Bunbury for final treatment.

Ten persons were employed in the mining operations while a further 25 persons were employed in the Bunbury separation plant. Twenty one people made up the staff and laboratory crews while four persons were employed full time in exploration activities.

During 1972 the companies mining the beach sands deposits did considerable rehabilitation work. Cable (1956) Ltd. completed some 15 acres of contouring, top-soiling and seeding. Western Titanium N.L. increased the acreage which that company has rehabilitated by 10 acres to a total of 67 acres. Western Mineral Sands Pty. Ltd. have rehabilitated mined out areas for many years and now possess some fine pastures.

IRON ORE

Total iron ore produced and sold in the year was 54,661,768 tons and includes ore used in the production of pig iron. This represents an increase of 3,359,655 tons on the previous year but there is a drop in value from \$388,706,948 in 1971 to \$387,988,067 this year. Revaluation of the Australian dollar relative to the United States dollar is the principal cause for the slump. The following table depicts the tonnages and grade of iron ore exported overseas this year.

TABLE 4
IRON ORE EXPORTED OVERSEAS

Mine	Tons	Average Assay % Fe.
Hamersley Iron Pty. Ltd.	21,422,509.94	64.46
Mt. Newman Mining Co. Pty. Ltd.	18,958,491.00	63.00
Goldsworthy Mining Ltd.	6,154,134.00	63.87
Dampier Mining Co. Ltd.	1,572,250.00	66.42
Cliffs W.A. Mining Co. Pty. Ltd.	1,368,758.00	58.99
Western Mining Corporation Ltd.	549,450.00	59.84
	50,025,592.94	63.695

Hamersley Iron Pty. Ltd. exported approximately 21.4 million tons of ore and pellets which average 64.46 per cent Fe. Production was comprised of 10.5 million tons of lump ore; 8.6 million tons of high grade ore; 10.2 million tons of low grade and 7.5 million tons of waste. From Paraburdoo the production was 1.3 million tons of high grade; 2.2 million tons of low grade and 0.7 million tons of waste.

During 1972, operations were resumed at Paraburdoo and the East Intercourse Island shipping facilities became operational. The first 150,000 ton capacity bulk carrier sailed from East Intercourse Island in July of this year.

This company has had an average labour force of 1,104 persons at Dampier; 1,110 persons at Tom Price; and 135 at Paraburdoo, with staff included throughout. The contractors labour force was reduced substantially during the year and was estimated to have averaged about 500 persons throughout all Hamersley's projects.

Mt. Newman Mining Co. Pty. Ltd. shipped 18.96 million dry tons of ore from Nelson Point while mining operations at Mt. Whaleback produced about 20.7 million dry tons for crushing. In its operations the company had to handle approximately 18.3 million dry tons of low grade ore and waste when excavating the high grade ore. The ore shipped averaged 63.00 per cent Fe.

At Mt. Whaleback, 7 new benches were developed including five in the West Pit and four new haul roads were built, three to serve the West Pit area.

A notable addition to the mine plant was the 200 ton capacity Haulpak Truck, which is being tested as a prototype for possible general use.

At Nelson Point an additional stockpile area was created and a new stacker and reclaimers were installed. Upgrading of the ore railroad was completed during 1972.

The company employed an average of 946 persons at the Newman area and 955 persons at Nelson Point.

Goldsworthy Mining Ltd. 6,154,134 tons of 63.87 per cent Fe ore was shipped from Finucane Island during 1972. The mine is now a true pit and requires a 2 : 1 ratio of waste/ore removal.

The company's expansion programme to include mining from Shay Gap and Sunrise Hill was substantially completed during 1972 with 29,140 tons of ore being mined at Shay Gap.

During 1973 the company plans to produce 8 million tons of ore with 4.5 million tons from Shay Gap, 1.5 million tons from Sunrise Hill and 2.0 million tons from Goldsworthy.

This company employs an average of 515 persons at Goldsworthy and 174 at Finucane Island. Contract personnel employed during 1972 averaged 350 persons.

Dampier Mining Co. Ltd. produced a total of 4,171,429 tons of high grade iron ore from Yampl and Koolyanobbing deposits. This ore had a nominal value of \$28,929,702.

From Koolan Island 1,572,250 tons of ore averaging 66.42 per cent Fe were shipped overseas and 66,923 tons averaging 65.70 per cent Fe were shipped to the Eastern States.

From Cockatoo Island 980,920 tons of 66 per cent Fe ore were shipped to the Eastern States.

Persons employed at Koolan Island averaged 173 while an average of 98 persons were employed at Cockatoo Island with 33 persons being engaged in administrative duties between both islands.

From Koolyanobbing, Dampier Mining Co. Ltd. railed 1,551,356 tons of 63 per cent Fe ore to Kwinana for blast furnace usage and overseas sales. This ore was nominally valued at \$11,612,943. An average of 79 persons were engaged at the Koolyanobbing operations of Dampier Mining Co. Ltd.

Cliffs Robe River Iron Associates completed the basic construction work during 1972, and by the end of the year had excavated an area measuring 1,145 feet by 415 feet to an average depth of 50 feet. Of 2.1 million tons of ore mined and railed to Cape Lambert 1.2 million tons of prepared sinter feed and 0.2 million tons of pellets were shipped.

Townsites at Pannawonica and Wickham were established during 1972 with 506 employees residing at Wickham and 116 people working at Pannawonica.

Production of 10 million tons of pellets and sinter feed per year is anticipated from this project.

Western Mining Corporation Ltd. produced 549,450 tons of 59.84 per cent Fe ore from the Koolanooka and Mungada deposits east of Morawa. This ore was valued at \$4,026,365.

During 1972 the work force was cut back to the extent that the average number of employees fell from 130 during the first half of the year to 97 during the second half of 1972.

The Charcoal Iron and Steel Industry at Wundowie obtained 98,113 tons of ore averaging 63 per cent Fe from the Koolyanobbing deposit. Pig iron produced amounted to 60,829 tons valued at \$3,987,937.

About 11 men were employed at the mine site.

Iron Ore Exploration

Armco—The Ores camp established at Kalgoonidi for the exploration of the Angela deposits was placed on a care and maintenance basis in July of this year when by formal allocation of T.R.s. it received a lesser area than was expected.

Packsaddle Areas—Goldsworthy Mining Ltd. sank two winzes to 250 feet each and have apparently fully evaluated the Packsaddle area.

Hancock-Wright—Work on the scree ore above and to the west of Wittenoom George appears to have been completed during 1972. Costeams were cut across the ore deposits as an alternative to the sinking of prospecting shafts.

At Rhodes Ridge a total of 1,130 feet of 7 ft x 7 ft adits were completed.

Between 20 and 30 persons were engaged in exploration work arranged by Hancock and Wright from their Wittenoom base.

McCamey Iron Associates Carpentaria Exploration Co. Pty. Ltd. continued with their exploration work at McCamey's Monster. During 1972 seven winzes (shafts) were commenced but poor ground conditions or water stopped all but two of them. Between 30 and 40 persons were engaged in this work.

LEAD

Mining was confined to the Northampton field where two companies were developing ore bodies for subsequent exploitation. 2,265 tons were treated for a production of 256 tons of concentrates.

LIMESTONE

Production statistics for this mineral are incomplete as much material is derived from land not held under the Mining Act. 1,129,720 tons valued at \$1,182,229 have been reported to the Department. The demand for limestone as a building stone has decreased markedly. The principal use is now for road base with other major uses being for industry, smelting flux, and the manufacture of Portland Cement. An innovation this year was the introduction by Cockburn Cement Company of a dredge which is excavating high grade limesand from beneath the waters of Cockburn Sound to a depth of forty-five feet.

LITHIUM

At their quarry at Londonderry south of Coolgardie Australian Consolidated Industries obtained 1,053.5 tons of Petalite which contained 4,424.70 units of Li₂O valued at \$16,771.25.

MAGNESITE

A production of 30 tons valued at \$450 was reported from a deposit East of Ravensthorpe. Further exploratory work on the body was continued during the year.

MANGANESE

The reported production of 97,934 tons of Manganese ore of an average assay of 42.60 per cent manganese was mined by Westralian Ores Pty. Ltd. from its claim at Mt. Sydney.

Testing of a deposit at Ripon Hills in the Pilbara Goldfield was continued.

NICKEL

Operations at the Nickel Refinery at Kwinana were maintained for the year. Apart from the production of nickel powder and briquettes at Kwinana the following by-products were recovered from the treatment of the nickel sulphides:—Ammonium sulphate 107,000 tons, copper sulphide 2,200 tons and mixed sulphides 570 tons. A new steam generating plant was commissioned during the year which utilises about 50 per cent West Australian natural gas as its fuel.

South of Boulder, commissioning trials of the Western Mining Smelter equipment were instituted late in the year, and the necessary adjustments and modifications were made to enable an early start at design capacity.

The total nickel ore concentrates produced during the year was 304,310 tons estimated to be worth \$84,493,697. This shows a decrease of 75,861 tons on production for 1971 and a drop in value of \$10,405,243. The ore treated by Western Mining Corporation was about the same so that the reduced production must be almost entirely attributable to a lower grade of ore passing through the mill with some of the decline in the value of production due to the devaluation of the American dollar.

At Kambalda Western Mining treated 1,111,849 tons including 71,219 tons purchased from Metals Exploration mine at Nepean. Ore reserves were reported as 22,319,383 tons at an average assay of 3.29 per cent Ni. This estimate shows an increase of two million tons on the 1971 figures together with 1 million tons treated for the year. The result indicates an extremely successful exploration programme. Footage of work completed for the period was shaft sinking 286 feet, decline drive 19,284 feet, driving and crosscutting 25,144 feet rising 1,432 feet and winzing 586 feet. In addition to the foregoing conventional development 6,823 feet of machine raise boring was completed.

Sinking of the Silver Lake Shaft continued and level development proceeded from the flats as they were opened up. Conversion of the stoping methods from slot mining to cut and fill was also maintained at this mine. On the Durkin Shaft, production continued from the upper levels while the No. 6 level was being driven. Sinking of the haulage shaft was advanced to 1,058 feet and a flat cut at the No. 9 level.

The decline adit servicing the Juan Shoot was advanced 2,500 feet to the elevation of the 9 level. Horizontal development was carried out on the 6, 7 and 8 levels of the mine. A Raise Bore was connected from the 7 level to the surface for ventilation purposes and a start made to continue the opening by identical methods to the No. 9 level below. Two 35 ton diesel trucks were introduced to transport the ore thus greatly increasing the efficiency of this operation.

In the McMahon decline adit the advance was 2,275 feet and level development was commenced on the Nos. 2 and 3 levels. Extremely bad ground conditions are a feature of this area making working methods difficult and entailing severe restrictions on the stoping methods used. Some decline adit footage was also done to the Gellately and Ken shoots.

Access to the Fisher Shoot was advanced a further 1,920 feet down the decline adit with another tunnel branching off to the "E" Zone. Level development was commenced on this shoot at the Nos. 2 and 3 levels.

Due to a recession in the world demand for nickel, operations at Carr Boyd were suspended for the last five months of the year and only a minor amount of development work was completed. Ore Reserves remained at the figure reported for 1971.

At the Scotia joint venture involving Great Boulder and North Kalgurli the Mitchell shaft was sunk to 1,100 feet and levels developed at the 830 foot and No. 10 level horizons. Reported production was 22,371.34 tons nickel concentrate assaying 12.16 per cent Ni and valued at \$7,494,200. This was won from 142,595 tons hoisted. Ore reserves declined to 1,218,640 tons averaged at 2.10 per cent Ni.

Development work during the year was 181½ feet of shaft sinking, 1,567½ feet of driving, 676 feet of crosscutting, 63 feet of winzing and 529 feet of rising. Development totalled 3,026 feet for the year.

Metals Exploration N.L. at Nepean reported a production of 71,274 tons averaging 2.70 per cent Ni and valued at \$3,298,563. This ore was treated at the Kambalda plant of Western Mining Corporation. A total of 11,699 feet of development was completed comprising 28 feet of shaft sinking 1,695 feet of decline driving, driving on lode 3,676 feet, crosscutting 1,877 feet, winzing 837 feet and 3,556 feet of rising. A programme of converting the stopping methods from resuing to rill stopping resulted in a loss of production for the year. Ore reserves were estimated at about 500,000 tons averaging 3.10 per cent Ni.

At their mine at Mt. Keith, Metals Exploration N.L. completed 2,225 feet of diamond drilling in two holes. Further feasibility studies on the economics of the work and metallurgical testing on the ore were continued during the year. Ore reserves are stated to be of the order of 300 million tons of 0.6 per cent Ni grade.

Poseidon Ltd. in the Mt. Margaret Goldfield continued to prepare the mine at Windarra for production. During 1972, 2,241 feet of decline adit was excavated, with 858 feet of crosscutting and 521 feet of rising. Bad ground encountered made the rate of progress less than expected. Exploratory drilling totalling 4,487 feet was completed and the ore reserves have been estimated to be in the order of 8.9 million tons of 1.87 per cent Ni grade. The South Windarra Nickel deposits previously owned by Union-Hanna Homestake have been taken over by Poseidon Ltd. and an open pit operation is being planned for this ore body.

Selcast Exploration Ltd. at Spargoville extended its vertical shaft 469 feet to 804 feet and was continuing to sink. Level development was commenced at the 406,602 and 805 feet horizons. On the 5B project 947 feet of decline adit was completed to 1,988 feet inclined distance, 247 feet of crosscutting and 254 feet of rising was done. Diamond drilling totalled 2,437 feet. No ore has yet been treated from the Selcast operations.

Anaconda Australia Inc. suspended sinking its Redross Shaft, at a depth of 840 feet in May of this year since when it has been on caretaker basis. Some bulk samples for metallurgical testing were extracted and 443 tons treated for an extraction of 82.72 tons of Nickel concentrate assaying 13.24 per cent Ni, 0.98 per cent Cu and 0.19 per cent Co. Reserves at this mine are estimated at 968,256 tons at 3.5 per cent Ni. From its Wannaway Shaft the company treated 443 tons for 76.95 tons of concentrates assaying 11.21 per cent Ni, 0.60 per cent Cu and 0.23 per cent Co. Reserves are given as 4,357,152 tons averaging 1.3 per cent Ni.

At Mt. Edwards work on the joint venture of B.H.P.-International Nickel was suspended in March of this year since when the mine has been on a caretaker basis. Work completed before the suspension became effective was driving 991 feet,

crosscutting 219 feet, rising 63 feet, surface diamond drilling 1,026 feet and underground diamond drilling 10,387 feet. No change in the ore reserves had been published. Some metallurgical testing of the ore was also done.

Western Selcast-Perseverance Project-Agnew. An extensive drilling programme was continued at this project where 75,866 feet of diamond drilling was completed from the surface and 367 feet underground. An exploration winze was sunk to 388 feet and 120 feet of crosscutting through ore completed. Reserves have been calculated to be 32,472,000 tons at a grade of 2.2 per cent nickel. A Pilot plant for the concentration of nickel ore from Agnew was built by the North Kalgurli Mines Ltd. at Kalgoorlie and put into commission.

PETROLEUM

The reported production was 15,402,695 barrels of crude oil valued at \$34,346,900.

Twenty three and a half million, million cubic feet of gas, nominal value of \$3,176,203 was also transmitted to industry in the metropolitan area. Associated with the production of gas 43,269 barrels of condensate were recovered for further refining. The report of the Petroleum Engineer deals in more detail with oil and gas.

SALT

Total production from the State reported to the Department was 2,182,824 tons valued at \$6,247,617.

This total was contributed to by Dampier Salt which exported 343,135 tons in its initial year; by Leslie Salt Co. at Port Hedland which shipped 271,958 tons; and by Texada Mines Pty. Ltd. which operates near Carnarvon, exporting 1,559,012 tons.

Near Widgiemooltha, Lefroy Salt Pty. Ltd. failed to make a sale of salt but efforts to produce an acceptable product free from contaminating magnesia are being pursued.

SEMI PRECIOUS STONE

The production of 194,536 lb. of material of a semi precious nature was reported in the year under review. The nominal value of this stone was \$47,074. Chalcedony, Moss Opal, Moss Agate, Chrysoprase, Amethyst, Variscite and Tourmaline are among gem stones sought. A deposit of precious opal was reported to have been opened up near Karonie. Production from this find has not yet been reported.

SILVER

For the year 133,320 fine ounces of silver valued at \$190,066 was produced as a by-product of gold mining and reported to the Department.

TALC

From its open cut mine near Three Springs, Three Springs Talc Pty. Ltd. extracted 25,602 tons of talc, which was marketed.

Westside Mines N.L. have opened up a talc deposit at Mt. Seabrook about 100 miles North West of Meekatharra. Stockpiles of about 6,000 tons of material have been built up on the surface. Planning and design for the erection of a treatment plant is well advanced.

TANTALO—COLUMBITE

All the production of this material for 1972 was derived as a by-product of tin mining operations. Concentrates separated totalled 265.52 tons containing 11,110 units of Ta₂O₅ and valued at \$1,201,689. Greenbushes Tin N.L. was the biggest producer, with 226 tons containing 9,786 units. Other producers were Vultan Minerals at Greenbushes and Pilbara Tin Pty. Ltd. at Moolyella.

TIN

The production and value of this mineral was more than double that of 1971. 2,005 tons of concentrates containing 1,410 tons of tin and valued at \$4,284,086 was reported as having been separated. Greenbushes was the source of 1,481 tons and the Pilbara yielded 524 tons.

The principal producer was Greenbushes Tin N.L. with an output of 1,376 tons of concentrate followed by Pilbara Tin Pty. Ltd. with an output of 319 tons. The next was J. A. Johnston and Sons Pty. Ltd. producing 132 tons from the Eleys centre in the Pilbara. Vultan Minerals Ltd. of Greenbushes produced 105 tons of concentrates. The balance of the output was derived from 4 to 5 small concerns in the Pilbara field.

URANIUM

For the first time in the history of the State the mineral uranium is commented on in the report of the State Mining Engineer.

Western Mining Corporation reported the discovery of the Yeelirrie deposit in January, 1972. Since this date 143,943 feet of drilling has been completed on the project. Ore reserves aggregating 45,756 tons containing 0.15 per cent U_3O_8 have been outlined and mine planning to allow early exploitation of the ore body is in progress.

VERMICULITE

A big increase in the tonnage of this mineral extracted from Mt. Palmer has been recorded for 1972. 206 tons valued at \$1,257 against 54 tons for 1971.

MINE INSPECTION AND ACCIDENT STATISTICS

J. M. Faichney—Mining Engineer and Acting Principal Senior Inspector of Mines

ACCIDENT STATISTICS

These statistics are for accidents reported to the Mines Department for the year, and include those occurring in all aspects of mining, construction work on mines, and in exploration and production of oil.

Where relevant the corresponding figures for the previous year are shown in brackets.

There were 18 (16) fatal and 479 (428) serious accidents.

The diagram of fatal accidents hereunder illustrates fatal mining accidents which have occurred yearly over the past 20 years and are classified according to the category of mining operation.

Table A gives the serious accidents classified according to the nature of the injury and to the mining district in which the accident occurred.

Table B shows the accidents (Fatal, Serious and Minor) segregated according to the mineral mined and processed, and also contains the number of men engaged in mining for each mineral. The employment figure includes those engaged in construction work.

Table C presents fatal and serious accidents segregated according to the accident cause and to the mining district.

WINDING MACHINERY ACCIDENTS

There were 12 accidents involving winding machinery and associated equipment. They consisted of one derailment, two involving the hanging up of a cage or skip in the shaft, two overwinds, a damaged winder drum and six miscellaneous accidents.

The derailment occurred in the underlay Regent Shaft of Central Norseman Gold Corporation N.L. due to a board on the rails but there was no damage to shaft or equipment.

The Cage/Skip hang ups were in vertical shafts and resulted in only minor damage to the shaft timber but in one case it was necessary to cut off 350 feet of the winding rope and recap it. The skip involved was removed from service.

The two overwinds were also in vertical shafts. One was due to winding in the wrong direction after tipping a skip, causing the rope to be detached, and the other was due to overshooting the level when lowering the cage and raising the counterweight to the sheave wheel. The counterweight was buckled.

A part of the flange of a winder drum at the Reward Shaft of Gold Mines of Kalgoorlie (Aust.) Ltd. broke away but this with five other sections on the flange which became suspect, were satisfactorily repaired.

The miscellaneous accidents included the failure of a rope at about the sheave position and was mainly attributed to mechanical damage from a loose weld fillet on the winder drum. Faulty signalling contributed to three accidents when equipment was being removed from cages resulting in damage to the cages and shaft timber. A winder rope was damaged by flying rock when a rise cut fired in an ore pass under construction broke through to the shaft. The cage was stationary. In the other accident pipes in a cage ascending to the surface moved and caught on the wall plates causing damage to the shaft and the gates of the cage.

In all cases repairs and replacement were carried out, and ropes were cut and recapped, to ensure compliance with safety requirements.

ADIT AND SHAFT ACCIDENTS

There were two accidents in the Juan Adit of W.M.C. Ltd. Kambalda Nickel Operations.

An unattended trackless rock loading vehicle got away from a parked position and ran down the adit and struck a Jumbo being used to drill at the bottom. A missing pin in the braking mechanism made the brakes ineffective. No one was injured.

A shiftboss's vehicle travelling down the adit collided with a rock haulage truck. The truck stopped before the collision. The brakes were in good condition and no reason can be advanced for the collision.

PROSECUTIONS

A miner who travelled on a kibble in a vertical shaft without wearing the safety belt provided was prosecuted. This was a breach of Regulation 77 of the Mines Regulation Act. The action was successful.

CERTIFICATES AND PERMITS ISSUED

The following were issued during the year:—

Sunday Labour Permits: Fourteen permits were issued. Five of these were required for mine safety and to avoid loss of time in subsequent working of the mine. Nine were issued in order to carry out work which was necessary to avoid loss of time to the subsequent work in the mine. Two applications for permits were refused as it was considered that the work could be done during normal working days.

Permits to Fire Outside Prescribed Times: Four of these were issued. All were subject to conditions to ensure safety in operation and maintain adequate ventilation.

Certificates of Exemption (Section 46 of the Mines Regulation Act): None were issued this year.

Permits to Rise: Permits for the construction of fifty rises totalling 5,200 feet were approved. A total of 5,577 feet were risen in sixty rises. Thirty-five rises (2,761 feet) were risen by conventional methods,

twenty-two rises (2,391 feet) were constructed using the Borehole and Gig method, and three rises (425 feet) in which a Raise Climber was used.

Underground Dam: Approval was given for the construction of an underground dam as a precautionary measure against flooding during drilling of a raiseborer hole which could intersect large aquifers.

Diesel Engine equipped units: Permits were issued for 36 of these units to be taken and used underground in mines.

AUTHORISED MINE SURVEYOR

The following persons were issued with Authorised Mine Surveyor Certificates by the Survey Board during the year:—

- D. A. Edelman—Certificate No. 176.
- P. King—Certificate No. 177.
- A. R. McGee—Certificate No. 178.
- G. A. Laffer—Certificate No. 179.
- R. J. Thomson—Certificate No. 180.
- T. W. Van Raven—Certificate No. 181.

VENTILATION

The ventilation of mine workings received constant attention.

The underground workings of all metalliferous mines throughout the State were inspected and dust counts and temperatures recorded. Many primary and secondary airflows were measured, and a general appreciation of ventilation conditions in each mine made. Assistance was also given at some mines in making airflow surveys and overcoming dust problems.

Inspections were made of crushing and screening sections of hard rock and iron ore quarries, the reduction section of metalliferous ore treatment plants, and the dry separation plants associated with mineral sands mining. Some assistance was given in overcoming dust collection problems associated with these operations.

The total number of dust samples taken in the year was 1,632. The table below gives the source of the samples and the average count. The figures shown in brackets are for 1971.

Dust Samples from	Samples Giving Over 1,000+ p.p.cc	Total Number of Samples	Average Count
Surface Plants	55 (57)	533 (433)	388 (406)
Assay Offices	(1)	(16)	(273)
Stopping	4 (6)	702 (379)	170 (230)
Levels	4 (7)	185 (133)	203 (282)
Development	3 (1)	212 (112)	185 (209)
	66 (72)	1,632 (1,073)	246 (306)

Counts of 1,000+ p.p.cc are included in the average count.

Undiluted Exhaust Gas

No. of Samples (Units)	Oxides of Nitrogen per cent	Carbon Monoxide per cent	Temperature Degree F.	Remarks
516	0.044	0.0146	127	Includes thirteen readings where the temperature exceeded 200°F.

Mine Atmosphere (Diluted)

No. of Samples (working places)	Oxides of Nitrogen per cent	Carbon Monoxide per cent	Carbon Dioxide per cent	Oxygen per cent	Temperature	
					Dry bulb degree F	Wet bulb degree F.
188	0.0004	0.0020	0.064	20+	71	65

GROUND VIBRATIONS

The Sprengnether Portable Seismograph was used to determine ground vibrations created by blasting in hard rock quarries, underground mining, a bauxite mining pit, harbour deepening and con-

struction programmes, and from earth moving equipment.

Dust Samples from	Samples Giving Over 4.0 mgms/m ₃	Total Number of Samples	Average mgms/m ₃
Surface Plants	42	138	3.84
Stopping	4	8	0.83
Level	4	12	3.74
Development	2	4	6.48
	48	157	3.84

Crushing plants on gold mines and at iron ore quarries were dusty but many operators (in iron ore plants particularly) work in air conditioned cabins which are thus pressurised and relatively free of dust.

There were no fatal fuming accidents from the fumes released in blasting with explosives but 18 minor accidents due to this cause were reported and investigated.

There was one major emission of methane which came from a diamond drill hole drilled to a depth of 3,000 feet from the surface on the Selcast Exploration Perseverance project near Agnew. The gas discharged to atmosphere for several days. Two minor occurrences of methane and hydrogen sulphide were encountered in the shaft on the Selcast Exploration Spargoville lease.

The sampling of the urine of men employed in gold assay offices to determine lead concentrations was continued in conjunction with the Department of Public Health. The gravimetric samplers were also used to test for total lead concentrations in the air in Assay Offices and the following results were obtained:

Number of samples—26.

Average—1.28 mgms/m³.

Number of samples exceeding threshold limit value of 0.20 mgms/m³—15.

There were ninety diesel engine equipped units in use underground, and regular sampling and analysing of the undiluted exhaust gas was maintained. A close check was kept on the mine atmosphere wherever diesel engine units were operated by sampling and analysing the air flows. The standards required for undiluted exhaust gases are 0.20 per cent by volume for oxides of nitrogen and 0.25 per cent by volume for carbon monoxide and the temperature not to exceed 170°. The concentration of any of the following constituents in the diluted exhaust gas is not to exceed 0.0025 per cent by volume of oxides of nitrogen, 0.01 per cent by volume of carbon monoxide, 0.25 per cent by volume of carbon dioxide and the oxygen content shall not be less than 20 per cent by volume.

The tables below show the average of the individual analysis made:

struction programmes, and from earth moving equipment.

The amplitude of vibrations set up in soils by a ten ton vibrating roller was measured at eight different localities in the Metropolitan Area for the Main Roads Department.

FATAL ACCIDENTS

Hereunder are brief descriptions of fatal accidents occurring during the year.

Name and Occupation	Date	Mine	Details and Remarks
Gabrielson, R. (Labourer)	12/1/72	W.A. Petroleum Pty. Ltd., Barrow Island	A front end loader that the deceased was driving slid over the edge of an embankment and rolled over.
De-Gois, J. F. (Labourer)	26/1/72	Hammersley Iron Pty. Ltd. Con- tractor—MKMO	He fell from a railway track maintenance car near the 224 mile peg on the Paraburdoo-Tom Price railway.
Hetherington, D. (Floorman)	28/1/72	W.A. Petroleum Pty. Ltd. Walvering No. 3 Well	Whilst working on the rig floor he was struck when the travelling block fell.
Caddy, D. C. (Contractor)	6/2/72	Hammersley Iron Pty. Ltd. Con- tractor—Dumez Aust. Ltd.	He lost control of a Scoopmobile on an access road to the Dampier-Tom Price railway and a wheel passed over him when he quit it.
Haliburton, J. (Welder)	14/2/72 Died	Cliffs Robe River Iron Asso- ciates. Contractor—Dravo	The deceased fell through an unsecured grid mesh floor and landed on his back
Fregnan, R. (Mechanical Fitter)	18/2/72 16/2/72	Pty. Ltd. Hammersley Iron Pty. Ltd. Con- tractor—EPT Pty. Ltd.	Electrocuted whilst preparing to use an electric appliance in the stockpile tunnel at Paraburdoo during construction.
Lassels, L. J. (Carpenter)	10/3/72	Cliffs Robe River Iron Asso- ciates. Contractor—Gerald- ton Bldg. Pty. Ltd.	Electrocuted when attempting to drink from a water cooler.
Roach, N. (Diesel loader driver)	13/3/72	Gold Mines of Kalgoorlie (Aust.) Ltd.—Mt. Charlotte Mine	A large slab of rock fell from the back of the drive and struck deceased on head and shoulders.
Southern, F. W. (Roustabout)	3/4/72	Burmah Oil Co. of Aust. Ltd. "Glomar Tasman" Angel No. 2 Well	He was asphyxiated when a fire broke out in a chain locker during oxy-acetylene cutting operations.
Kinderman, G. (Manager of Diving Co.)	8/4/72	Burmah Oil Co. of Aust. Ltd., "Big John" Goodwyn No. 2 Well	The shearing of a retaining pin of a loaded pulley wheel allowed the pulley to be projected from its support and it struck the deceased.
Chisholm, R. (Skipman)	11/6/72	Western Mining Corporation Ltd. (Kambalda Nickel Op- erations) Durkin Shaft	During shaft maintenance the deceased fell from the top of the skip.
Browne, G. J. (Truck driver)	20/6/72	Western Mining Corporation Ltd. (Kambalda Nickel Op- erations). McMahon Mine— Contractor—Shepherdson Pty. Ltd.	Whilst reversing to tip rock on dump the edge collapsed and he was crushed when thrown out of the cabin as the truck rolled over.
Perry, W. F. (Apprentice fitter)	25/6/72	Gold Mines of Kalgoorlie (Aust.) Ltd. Mt. Charlotte Mine	He was travelling alone in a cage and his head was struck by shaft timber at the 900 feet level as the cage ascended.
Poole, L. E. (Geologist)	25/7/72	Poseidon Ltd. Exploration at Mt. Weld	Drowned after being fumed by carbon monoxide from a petrol engine operated pump installed underground in a well.
Frost, D. W. (Leading Hand Plant Operator)	19/8/72	Goldsworthy Mining Ltd.	The dump truck he was driving collided with the rear of another dump truck during loading operations.
French, W. G. (Hydraulic fill operator)	7/9/72	Gold Mines of Kalgoorlie (Aust.) Ltd. Perseverance Mine	The deceased was asphyxiated when slime collapsed and buried him as he was attempting to consolidate it.
Van Uden, M. H. (Bulldozer driver)	7/10/72	Goldsworthy Mining Ltd.	The bulldozer he was operating overturned down an incline on the stockpile and crushed him.
Wilson, L. W. (Electrical Fore- man)	11/10/72	Alcoa of Aust. (W.A.) Ltd.— Kwinana	Electrocuted whilst lubricating thread on bolts preparatory to repairing an electrostatic precipitator.

DIAGRAM OF FATAL ACCIDENTS

SEGREGATED ACCORDING TO CLASS OF MINING

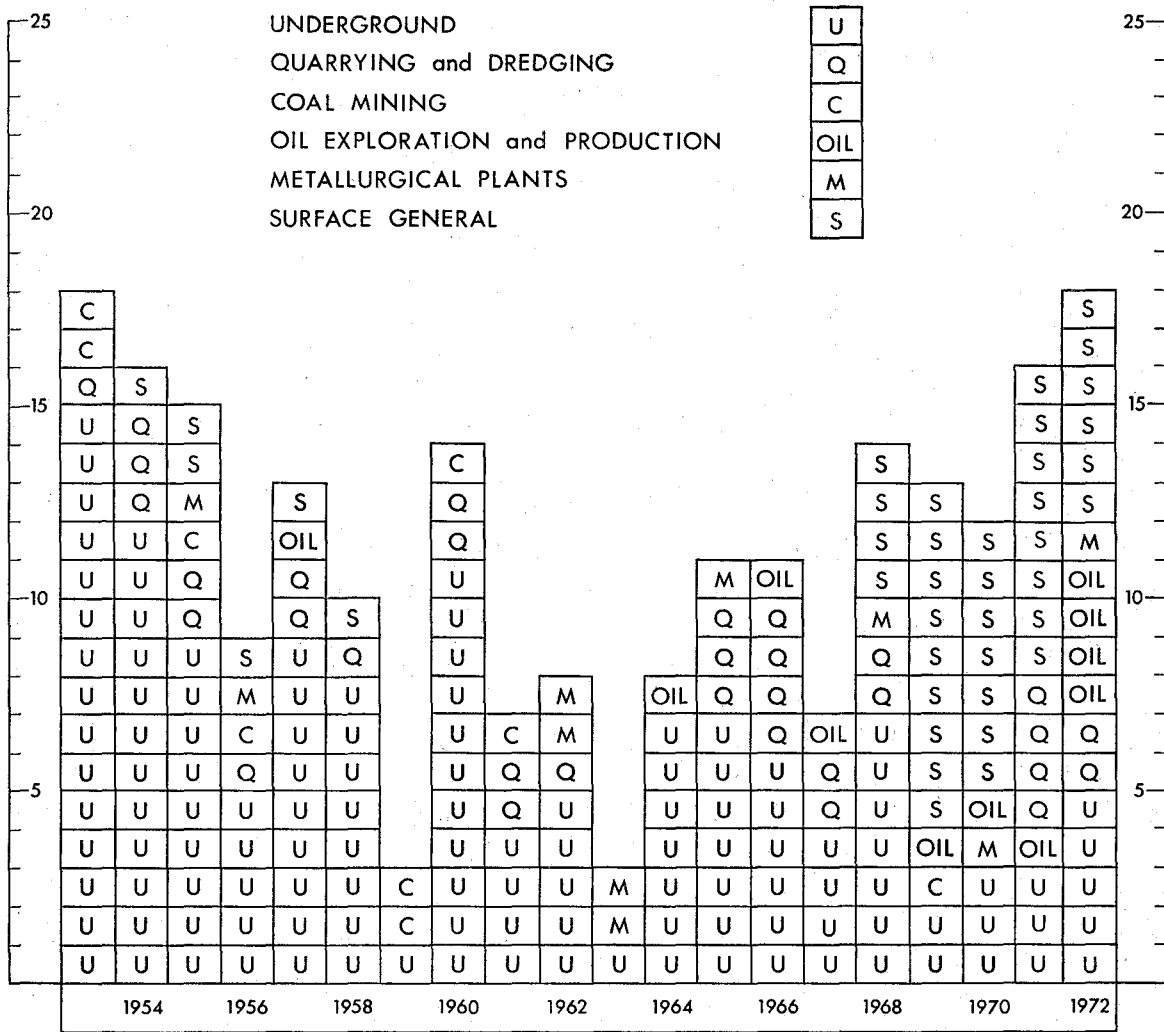

TABLE "A"
SERIOUS ACCIDENTS FOR 1972

Class of Accident	Kim-berley	West Kim-berley	Pil-bara	West Pil-bara	Ash-burton	Peak Hill	Gas-coyne	Murchi-son	East Murchi-son	North Cool-gardie	Broad Arrow	East Cool-gardie	Cool-gardie	Dun-das	Green-bushes	South-West	Collie	Total
<i>Major Injuries (exclusive of fatal)—</i>																		
<i>Fractures—</i>																		
Head			2	2		1												3
Shoulder			1								1							3
Arm				4		1						1				2	1	10
Hand				1								1						2
Spine				3														4
Rib			1	2							1	1						8
Pelvis				2												1		3
Thigh				2												1		3
Leg			1	4				1			1	1	1			4	1	14
Ankle			1	4		1							1			1	1	9
Foot		1	1	4									2			3	2	13
<i>Amputations—</i>																		
Arm																		
Hand																		
Finger				3							1	3	2	1			1	11
Leg												1						1
Foot																		
Toe																		
Loss of Eye				1														1
Serious Internal Hernia				1														4
Dislocations	1		1									2				1		4
Other Major			5	9		3						2	1				3	23
Total Major	1	1	13	42		6		1			4	12	7	1		13	14	115
<i>Minor Injuries—</i>																		
<i>Fractures—</i>																		
Finger				4			1					9	3			2		19
Toe			3	6								2				1		12
Head				1								11	3			2		17
Eye	1										2	7	2	2				17
Shoulder								1				3	3	2				7
Arm												12	3					17
Hand								4		1	1	20	6			1	3	36
Back			2	4	1			1	1	2	1	25	24		1	15	6	83
Rib	1																	1
Leg	1	1	1	2			1	3		1	3	32	14	1		12	6	78
Foot			1									8	7		1	7	1	25
Other Minor	1	2		7	2			2			1	13	14			4	6	52
Total Minor	4	3	7	24	3		2	11	1	4	8	142	79	3	2	49	22	364
Grand Total	5	4	20	66	3	6	2	12	1	4	12	154	86	4	2	62	36	479

There were no serious accidents reported in the following Goldfields :—Yalgoo, Northampton, Mount Margaret, Phillips River, North-East Coolgardie, Yilgarn, Warburton, Nabberu and Eucla.

Table 'B' shows the fatal, serious and minor accidents reported and the number of men employed, classified according to the mineral mined.

TABLE "B"
ACCIDENTS SEGREGATED ACCORDING TO MINERAL MINED AND PROCESSED

Mineral	Men Employed	Accidents		
		Fatal	Serious	Minor
Bauxite (Alumina)	1,734	1	25	90
Coal	619	36	168
Copper	32
Gold	2,031	3	160	400
Gypsum	44
Ilmenite etc	434	10	58
Iron	6,396	7	85	359
Lead	13
Manganese	36
Nickel	2,860	3	120	398
Oil (Production and Exploration)	655	4	29	86
Salt	353	4	3
Tin	176	2	11
Other Minerals	165	1	2
Rock Quarries	310	7	18
Totals	15,279	18	479	1,593

Table 'C' shows the fatal and serious accidents classified according to the accident causes and also shows the different Mining Districts in which the accidents occurred.

1972
TABLE "C"
FATAL AND SERIOUS ACCIDENTS SHOWING CAUSES AND DISTRICTS

District	Explosives		Falls		Shafts		Fumes		Miscellaneous Underground		Surface		Total	
	Fatal	Serious	Fatal	Serious	Fatal	Serious	Fatal	Serious	Fatal	Serious	Fatal	Serious	Fatal	Serious
Kimberley	5	5
West Kimberley	1	3	4
Pilbara	2	20	2	20
West Pilbara	1	7	65	7	66
Ashburton	1	3	1	3
Peak Hill	6	6
Gascoyne	2	2
Murchison	2	7	3	12
East Murchison.....	1	1
Yalgoo
Northampton
Mount Margaret	1	1
North Coolgardie	3	1	4
Broad Arrow	1	9	2	12
North-East Coolgardie.....
East Coolgardie	1	11	1	1	1	87	55	3	154
Coolgardie	7	1	1	3	53	1	22	2	86
Yilgarn
Dundas	1	3	4
Phillips River
Greenbushes	2	2
South West	2	62	2	62
Collie	23	13	36
Nabberu
Warburton
Eucla
Total for 1972	1	21	2	1	1	5	1	185	13	267	18	479
Total for 1971	1	4	16	1	6	1	126	13	276	16	428

PETROLEUM EXPLORATION AND PRODUCTION

A. J. Sharp—Petroleum Engineer

BARROW ISLAND OILFIELD

(Operators—West Australian Petroleum Pty. Ltd.)

During the year the Barrow Island oilfield produced 15.5 million barrels of crude oil. The average rate of crude oil production throughout the year was 42,000 bbls. per day compared with an average production rate in 1971 of 44,000 bbls. per day.

Low temperature separation plant for the recovery of L.P.G. from natural gas was installed and commenced operation in the latter part of the year. The L.T.S. plant is designed to process up to 10 million cubic feet per day of natural gas and recover about 400 barrels per day L.P.G. from the gas stream.

Preparations were made to test two of the Pasco wells in order to evaluate the reserves of the Pasco structure. Testing is expected to commence in early 1973.

The Barrow Island Deep Test Well was spudded in September, 1972. The well is being drilled for the purpose of evaluating the petroleum potential of the formations below the currently producing intervals to a depth of 15,000 feet. At the year end the well had reached a depth of 10,625 feet and action was being taken to control well pressure.

	No. of Wells December, 1971	No. of Wells December, 1972
Producing oil wells	328	320
Part-time producing oil wells
Non-producing oil wells	12	16
Water injection wells	153	157
Water source wells	9	9
Total number of wells	502	502

DONGARA/MONDARRA/GINGIN/WALYERING GAS FIELDS

(Operators—West Australian Petroleum Pty. Ltd.)

Natural gas production from the Dongara and Mondarra gas fields increased from 33 million cubic feet per day in January, 1972, to 81 million cubic feet per day in December, 1972. Production is expected to continue at about 80 million cubic feet per day until further natural gas reserves are discovered and developed.

During the year extended production tests were carried out on the Walying No. 1 well and the Gingin No. 1 well. In both cases the results of the testing confirmed that only minor natural gas reserves were present in the wells. Both wells are now shut in.

DONGARA TO PINJARRA NATURAL GAS PIPELINE

(Operators—West Australian Natural Gas Pty. Ltd.)

The pipeline operated continuously throughout the year. The highest monthly throughput occurred during October when gas transmission exceeded an average rate of 85 million cubic feet per day.

Lateral pipelines were constructed to the Western Mining Nickel Refinery and the Fremantle gasworks. The lateral pipeline which supplied the S.E.C. power station and the Alcoa plant at Kwinana was looped to allow demand to be met at reduced pipeline pressures. During the year the construction of four compressor stations was commenced and at the year end, three compressor stations were operational.

LAND EXPLORATION AND APPRAISAL DRILLING

Land exploration drilling activity increased from 23 rig months in 1971 to nearly 26 rig months in 1972.

Indications of natural gas with possible commercial significance occurred during the drilling of the Barrow Island Deep Well (Operators—West Australian Petroleum Pty. Ltd.). The well penetrated a high pressure gas interval at approximately 10,600 feet. Drilling and testing has been delayed by the occurrence of lost circulation into formations above the high pressure gas interval. The well is to be tested after being drilled to total depth.

Land exploration and appraisal drilling operations are summarised in the attached table.

OFFSHORE EXPLORATION AND APPRAISAL DRILLING

Offshore drilling activity remained at about the same level as in 1971 (approximately 37 rig months).

New petroleum discoveries of probable commercial significance were made at the Angel No. 1 (Operator—BOCAL) well and the Eagle Hawk No. 1 well (Operator—BOCAL). The Angel No. 1 well produced on test 13 million cubic feet gas per day on a $\frac{1}{2}$ in. surface choke together with 57 bbls. per million cubic feet condensate. The Eagle Hawk No. 1 well produced on test 1,645 bbls. per day oil on a $\frac{3}{8}$ in. surface choke.

Appraisal drilling was carried out by BOCAL on the North Rankin (2 wells), Angel (1 well) and Goodwyn (2 wells) structures in order to evaluate the petroleum reserves and feasibility of commercial production from these structures.

Towards the end of the year the West Tryal Rocks No. 1 well (Operators—West Australian Petroleum Pty. Ltd.) penetrated hydrocarbon zones of possible commercial significance and it is expected these zones will be tested during 1973.

Offshore exploration and appraisal drilling operations are summarised on the attached table.

AVERAGE DAILY CRUDE OIL AND NATURAL GAS PRODUCTION BY MONTHS

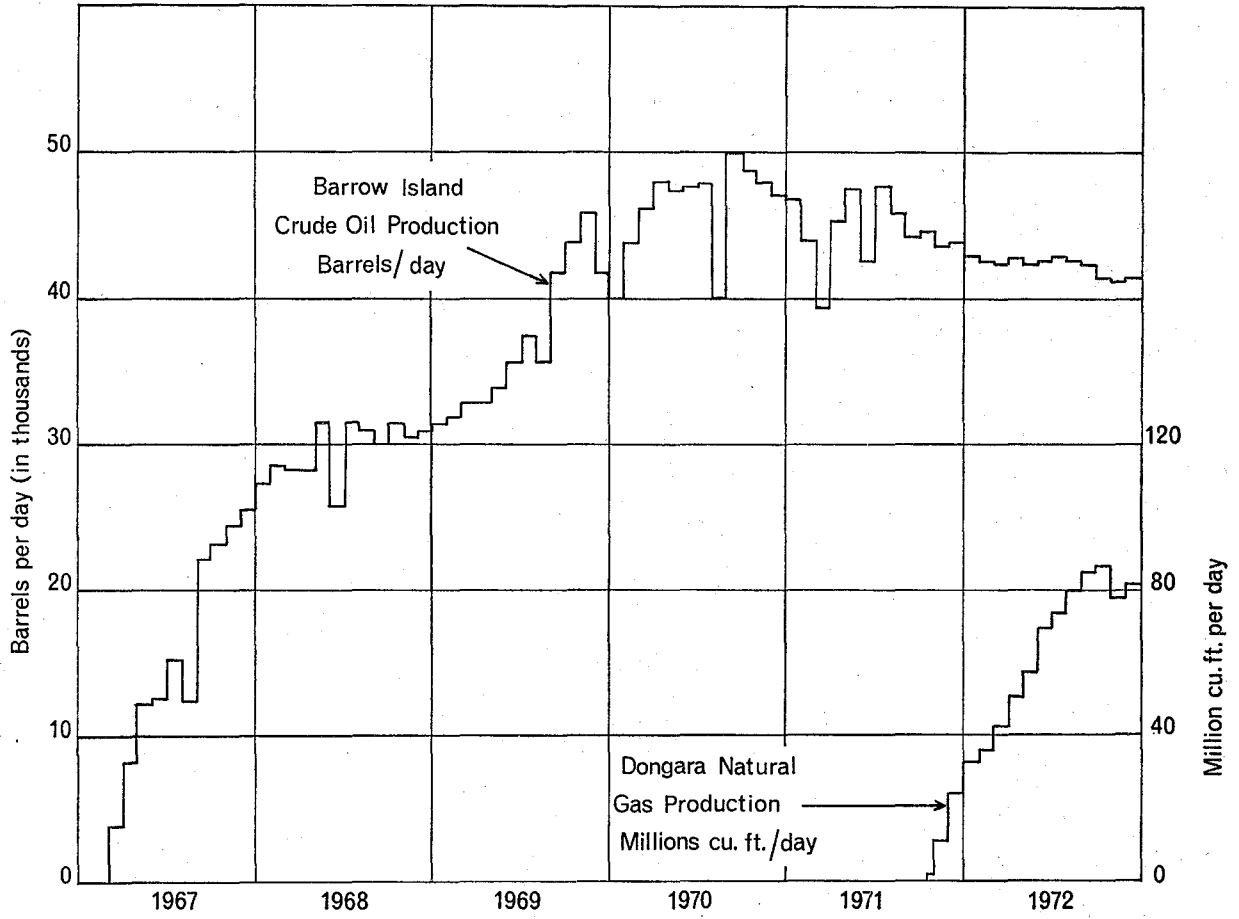

**OFFSHORE PETROLEUM EXPLORATION/APPRaisal.
DRILLING IN WESTERN AUSTRALIA.**

Operator	Contractor	Rig	January	February	March	April	May	June	July	August	September	October	November	December
B.O.C.A.L.	Global Marine	Glomar Tasman	Angel—1 11,190' Gas/Con- densate Suspended	Rob Roy —1 7,500' Pl. & abd.		Angel No. 2 14,425' Gas/Condensate Suspended				Picard No. 1 13,832' Pl. & abd.		Malus No. 1 12,000' Pl. & abd.		Rosemary No. 1 Drilling
B.O.C.A.L.	Odeco	Ocean Digger								North Rankin No. 3 Gas/Condensate 13,427' Suspended		North Rankin No. 4 Gas/Condensate 13,323' Suspended		Hauy —1 2,708' Pl & abd. Good- wyn No. 3 Dlg.
B.O.C.A.L.	Atwoods Oceanics	Big John				Goodwyn No. 3 12,303' Gas/Condensate Suspended		North Rankin No. 2 12,303' Gas/Condensate Suspended		Sable No. 1 13,030' Pl. & abd.		Cossigny No. 1 10,510' Pl. & abd.	Eagle Hawke—1 11,450' Oil Suspended	Eg- ret Dlg.
W.A.P.E.T.	Zapata	Navigator						North Tryal Rocks No. 1 12,000' Pl and abd.		West Muiron—1 1,053' Pl. & abd.		West Muiron No. 1A 1,133' Pl.&abd.		West Tryal Rocks No. 1 Drilling
A.R.C.O.	Sedco	135 G							Penguin—1 9,045' Pl. & abd.		Eider No. 1 9,300' Pl. & abd.			Plover—1 8,000' Pl. & abd.
Ocean Ventures	Odeco	Ocean Digger						Edel No. 1 9,018' Pl. & abd.						

In the above table "Pl and abd" means "plugged and abandoned". "Dlg" means "drilling".

**LAND PETROLEUM EXPLORATION/APPRaisal.
DRILLING IN WESTERN AUSTRALIA 1972.**

Operator	Contractor	Rig	January	February	March	April	May	June	July	August	September	October	November	December
W.A.P.E.T.	O.D. & E.	Ideco Super 7-11		Walyering No. 3 13,738' Plugged and abandoned					Munro —1 6,941' P. & A.		Logue No. 1 8,854' Pl. & abd.		Bullsbrook No. 1 13,996' Pl. & abd.	Lake Preston Dlg.
W.A.P.E.T.	Intairdriil	Ideco H-35				Cunalooc—1 2,616' P. & A.		East Marilla 2,094' P. & A.		Pen-der 2,991' P. & A.	Palm Springs—1 3,500' P. & A.			Barb-wire— 3,515' P. & A.
W.A.P.E.T.	Shelf	National 1320											Barrow Deep No. 1 Drilling	
Union/ W.A.P.E.T.	Shelf	National 1320							Wonnerup No. 1 15,510' Pl. & abd.					
Abrolhos/ W.A.P.E.T.	O.D. & E.	Ideco H-525				Narlingue No. 1 6,989' Pl. & abd.		Heaton No. 1 8,000' P. & A.						
Hematite/ W.A.P.E.T.	Intairdriil	Franks Rocket	Cane River Nos. 3, 4 & 5 P. & A.											
Hematite/ W.A.P.E.T.	Austral United	Mayhew 2000											Woorawa No. 1. 664'. Pl. & abd. Windoo No. 1. 718'. Pl. & abd. Surprise No. 1. 710'. Pl. & abd. Mardie West No. 1. 444'. Pl. & abd. Coonga No. 1. 579'. Pl. & abd.	
Hartogen	Glindeman Kitching	Diamond Drill											Moogooree—1. 420' Moogooree—2. 629' Bidgemia—1. 595' Pl. & abd.	
A.R.C.O.	O.D. & E.	Ideco H-40							Pelican Island No. 1 6,500' Pl. & abd.					

In the above table "P & A" or "Pl & abd" means "plugged and abandoned". "Dlg" means "drilling".

COAL MINING

R. S. Ferguson—Mining Engineer—Senior Inspector of Coal Mines

The aggregate output of coal produced on the Collie Coal Field during 1972 amounted to 1,149,100 tons, a decrease of 22,523 tons compared with the 1971 output of 1,171,623 tons. This represents a decrease of 1.92 per cent on the 1971 output.

The three collieries contributing to the output were Western No. 2 Underground mine, Western No. 5 Open Cut and Muja Open Cut.

The total value of the coal produced during 1972 was \$5,907,162 an increase of \$172,809 compared with the 1971 value of \$5,734,353.

The open cut component of the total output decreased by 1.34 per cent to 63.80 per cent.

Western Collieries Ltd.—Western No. 2 Mine

This colliery's output of 415,898 tons of coal was an increase of 7,518 tons compared with the 1971 output of 408,380 tons. The Wyvern seam coal which is approximately 13 feet thick is worked by bord and pillar system at a plan percentage of extraction of approximately 45 per cent on first working. The mine district vary greatly in size and shape as do the panels within them but generally, the panel lengths do not exceed twenty chains in any direction between the one chain wide barrier pillars.

The pillar sizes and working dimensions are practically similar throughout the range of depths of cover to over 500 feet as it is proposed to recover significantly more of the seam on a second working when pillars will be split and roof coal taken.

Coal is won from the faces by "grunching" or blasting off the solid followed by loading out onto scraper chain conveyors which in turn, deliver onto the belt conveyor system. Loading is effected with hand held scoops or by the application of diesel powered front-end-loaders. At present, approximately 60 per cent of the output is won by the scoop loading technique.

During the year, mining continued in the panel areas of the No. 1 west, No. 4 west, No. 6 west and No. 6 east districts and development drivages continued in the No. 2 west, No. 4 west dips, No. 3 east and Cullen Headings development areas.

The physical conditions of the floor, roof and sides were generally good throughout the mine, the only exception being local areas affected by soft floors in the No. 2 west headings and "vug" affected strata in No. 1 west district.

Western Collieries Ltd.—Western No. 5 Open Cut Mine

The output of this mine was 125,526 tons a decrease of 25,964 tons compared with the previous year when the output amounted to 151,490 tons.

Coal was won from two seams: 53,033 tons from the Cardiff or top seam which averages 13 ft. in thickness over the area worked out, and 72,493 tons from the North Seam which is approximately 30 feet below the Cardiff seam and is approximately 8 feet in the current working areas.

Good progress was made on opening out the current Cardiff Seam excavations which were, at the end of the year, approximately 16 chains long and approaching 3 chains wide. Work continued on advancing the Neath Seam high wall as part of the Stage 2 project on that seam and back-filling of overburden into mined out areas, was carried out satisfactorily.

A trackless diesel operated front-end-loader was used on coal loading and the possible application of an hydraulic excavator was being investigated.

Safe conditions were maintained in and around the excavations including the roads and dumping areas and good illumination was provided in all areas where work was carried on during the hours of darkness on afternoon shift.

The Griffin Coal Mining Company Limited—Muja Open Cut.

The largest individual mine output on the field was again produced at this colliery. The output of 607,677 tons was however, a reduction of 4,077 tons compared with the previous year's output of 611,754 tons.

A quantity of 2,824,723 cubic yards of overburden was removed to expose coal—an average of slightly more than 12,280 cubic yards per working day through the year. An additional 99,355 cubic yards of overburden was removed during pit preparation procedures which did not include coal exposure. The average ratio of overburden removed to coal mined was 4.65 to 1.

There was a total quantity of 320,000 tons of exposed coal reserves at the mine at the end of the year and it is evident that the very good progress being made on overburden removal would rapidly lead to greatly increased exposed reserves.

The systematically planned programme of development and back-filling at the mine is becoming evident in the workings, particularly now that the faces, benches and berms are gradually being straightened out to a position directly across the short axis of the Muja Formation Basin.

Drainage works to minimise the access of surface water into the workings and to handle and control water in the excavations have been a prominent feature of the forward planning. The lighting arrangements around the dumps, roads and excavations were extended as necessary and were maintained to the usual very high standards of illumination provided at this mine.

The workings of this multiple seam open cut colliery where ultimately nine seams will be worked are now in an impressive scale with the opened out workings over one mile in length, and at a depth ranging to over 230 feet from the surface. At present, five seams of an average aggregate thickness of sixty eight feet are being worked. As the top levels of the excavations advance into the basin, the four higher seams with an average aggregate thickness of twenty four feet will, when added to the present seams being worked, give a total average coal thickness of ninety two feet.

General

There were no fatal accidents during the year and the accident record in the coal mining industry continued to be good. There were 204 reported accidents of which, 168 were minor and 36 were classified as serious, mainly for statistical purposes where an employee was absent from work for 15 days or more.

Western Collieries and Peabody Pty. Ltd. continued the programme of exploration commenced in 1971 to define the status of the coal reserves contained within the 50 leases presently held or under application by the joint venture company and Western Collieries Ltd.

Open hole drilling accounted for 55,634 feet and 13,592 feet were core drilled.

Westcoll Research Laboratories continued analytical services to the exploration programme including the assaying of 149 coal cores. Increasing quantities of dried coal and char are being produced

through the pilot plant and research is continuing to improve the quality of these materials and the range of markets.

At the end of the year, the total number of personnel employed in the coal mining industry was 619. Approximately one third of this number was employed in open cut mining and two thirds in underground mining including surface operations.

DRILLING OPERATIONS

D. A. MacPherson—Drilling Engineer

During 1972, the Drilling Section was responsible for the drilling of 9,857 metres (32,331 feet) in 298 bores and the testing by pumping of five bores. The drilling of 9,582 metres (31,437 feet) and the testing of five bores was carried out by Departmental employees and equipment. The remaining 275 metres (904 feet) in six bores was carried out by contract.

This year, the metreage completed by the Drilling Section is the highest on record. In 1967, 8,718 metres (28,604 feet) were drilled.

A brief resume of each job follows and a table of the work carried out is given at the end of this report.

Comments on Staff and Plant matters are also given.

WATHEROO LINE

This drilling programme formed part of the State wide ground water investigation conducted by the Geological Survey of Western Australia and was financed by the Department of Mines. The Watheroo Line runs West from Watheroo to the coast. The drilling was required to provide information on stratigraphy and ground water conditions to a projected depth of 762 metres (2,500 feet) at selected sites on the line. This was generally affected by drilling one bore to target depth to provide strata samples, geophysical bore logs and side wall cores. The bore was then screened at a selected depth and air lifted to provide accurate water samples and water level measurement for the aquifer at the selected depth. Subsequent bores were drilled at the same sites to provide water quality and water level measurements for aquifers at different depths. The bores were left in suitable condition for continuous water level measurements.

At the beginning of the year, three sites remained to be completed on the line. These sites were drilled during the year and the job completed.

ENEABBA LINE

This drilling programme forms part of the State wide ground water investigation conducted by the Geological Survey of Western Australia and is financed by the Department of Mines. The Eneabba Line commences about 15 miles West of Winchester and runs West along the Carnamah/Eneabba Road and continues West past Eneabba to within 5 miles of the coast. The programme is required to provide information on stratigraphy and ground water conditions to a projected depth of 762 metres (2,500 feet) at selected sites on the line. This is generally effected by drilling one bore to target depth to provide strata samples, geophysical bore logs and side wall cores. This bore is then screened at a selected depth and air lifted to provide accurate water samples and water level measurements for the aquifer at the selected depth. Subsequent bores are drilled at the same sites to provide

water quality and water level measurement for aquifers at different depths. The bores are left in suitable condition for continuous water level measurements.

This job was commenced during the year and, by the end of the year, work at one site had been completed and drilling was in progress at a second site.

MILLSTREAM

This was a ground water investigation carried out for and financed by the Department of Public Works to locate if possible further ground water supplies for the Roebourne/Dampier area. The work was done on Millstream Station near the foot of the Hamersley Ranges. The drilling was required to provide information on stratigraphy and ground water conditions at three sites. The work was done by cable tool drilling the upper softer formations and diamond drilling the underlying harder formations and carrying out pumping tests on selected aquifers.

The operation was commenced and completed during the year.

GNANGARA SAND BEDS

This drilling programme was a continuation of an investigation of Perth's ground water resources, conducted on behalf of the Metropolitan Water Supply, Sewerage and Drainage Board and financed by that Department.

At the beginning of 1972, the only work remaining to be done, was the removal of casing and screens from 12 bores. This work was completed during the year and all plant and materials were removed from the job.

COOYA POOYA—ROEBOURNE

This was an investigation into the possibility of obtaining water for Roebourne and associated towns from ground water sources additional to those already being utilised. The work was carried out for and financed by the Public Works Department.

Late in 1971, the bore had been drilled by cable tool methods to a depth of 70 metres. Early in 1972, this bore was tested by pumping and subsequently, the bore was deepened to 244 metres by diamond core drilling. No further water was encountered in the diamond drilled section of the hole and the job was completed at that stage.

As this initial bore gave very encouraging results, a further stage of this job will be carried out in 1973.

BUNBURY HARBOUR

This drilling was carried out to provide information on foundation conditions in Bunbury Harbour, required for preparation of designs for a land backed berth. The work was carried out on behalf of and financed by the Public Works Department

The work involved obtaining samples by thin wall sample tube and diamond core drilling underlying harder strata.

The work was commenced late in 1971 and was carried out to completion during 1972. Some of the work was done with the plant on land and some with the plant mounted on a barge floating in the harbour.

JOONDALUP

This drilling programme forms part of the State wide ground water investigation conducted by the Geological Surveys of Western Australia and is financed by the Department of Mines. The Joondalup job lies in the area between Yanchep, Muchea, Perth and the West Coast. The work is required to provide information on stratigraphy and ground water conditions to a projected depth of about 76 metres (250 feet) at selected sites in the area. This is being done by drilling one bore to target depth to provide strata samples, geophysical bore logs and bottom hole core. This bore is then screened at a selected depth, developed and tested. Prior to testing, observation bores to observe movements in water levels are drilled near some of the pumping bores. One bore on each site is left in suitable condition for continuous water level measurements.

The work was commenced early in the year. All equipment had to be removed hurriedly from the first site to avoid having it burnt in a bush fire. After completion of one site, work was suspended until November when work was in progress at the end of the year. The job will be continued in 1973.

PORT HEDLAND INDUSTRIAL BORE

This was a ground water investigation carried out for and financed by the Public Works Department. Its purpose was to find out whether water of industrial quality (up to 10,000 parts per million total dissolved solids) existed in quantity at reasonable depths in the Port Hedland Town area. The job consisted of drilling through sediments to granitic bed rock and testing any promising aquifers.

Preliminary testing on completion of drilling showed that the water encountered was too salty for industrial use and the full scale testing was not carried out.

On completion of the work, all equipment and materials were removed from the site.

PILBARA DAMSITES

This was a damsite investigation carried out for and financed by the Public Works Department to obtain preliminary information on rock conditions at a number of possible damsites for Pilbara water supply purposes. The work involved diamond core drilling at each damsite on selected bore sites.

Drilling was carried out at Cooya Pooya damsite on the Harding River, at Kangan Pool Damsite on the Sherlock River and at Bullinarwa Damsite on the Fortescue River.

The work at Kangan Pool damsite was hampered by personnel troubles and at Bullinarwa by a thick layer of boulders overlying bed rock.

On completion of the work, all plant and materials were removed from the site.

CANNING BASIN

This drilling programme forms part of the State wide ground water investigation conducted by the Geological Survey of Western Australia and is financed by the Department of Mines. The Canning Basin is a large, sedimentary geological province extending from the DeGrey River along the Coast past Broome and East towards the Northern Territory Border. The drilling programme is required to provide information on stratigraphy and ground water conditions to bedrock over the whole basin. The work was commenced in the corner of the basin near the DeGrey River and the coast and will extend outwards from there.

The information is being obtained by drilling at each site one bore to bedrock to provide strata samples, geophysical bore logs and some cores. This bore is then screened at a selected depth, developed and tested. Subsequent bores are drilled at the same site to allow screening, developing and testing of aquifers at different depths. The bores are left in suitable condition for continuous water level measurements.

The work also involves drilling shallow shot holes for use in seismic surveys being carried out by G.S.W.A.

The work was commenced during the year and was suspended prior to the commencement of the wet season. It will be recommenced in 1973 on cessation of the wet season.

FITZGERALD RIVER

This was a lignite investigation carried out for and financed by the Department of Mines. The work was done in the Fitzgerald River Valley approximately 30 miles from Jerramungup. The work was required to provide information on the extent and quality of lignite deposits in the river valley as a basis for decision on whether to allow mining of the area which is part of a flora and fauna reserve. The work was done by auger drilling to a projected depth of 30 metres (100 ft.), obtaining samples of the lignite in the process by using wire line core barrel in the hollow augers.

The work was successfully completed in one month and all equipment and materials were removed from the site.

ROLEYSTONE TUNNEL

This was a tunnel investigation job carried out for and financed by the Metropolitan Water Supply Sewerage and Drainage Board to obtain information on rock conditions at the portals and mid point of a proposed tunnel for water reticulation to Perth.

The work involved diamond core drilling at each end of the proposed tunnel and at a site approximately half way along the tunnel. Selection of bore sites and geological supervision was carried out by the Snowy Mountains Engineering Corporation. The work was done by contract, administered and supervised by the Drilling Section.

The job was completed during the year and all equipment and materials removed from the site.

STAFF

During 1972 the only staff change was the resignation of Mr. R. Snaire, general assistant in the Carlisle Drill Store. His place was taken by Mr. N. Francis.

PLANT

During 1972 a truck mounted, medium capacity rotary drilling plant and a trailer mounted power swivel unit received towards the end of 1971, were placed in service.

A geophysical logging unit was received during the year and placed in service. This is used by the Geological Survey of Western Australia. A side wall coring unit was received and placed in service.

The sale of a Mindrill A2000 diamond drilling plant was finalised. This machine has been offered for sale during 1971 but the matter had not been finalised.

Various items of plant which had reached the end of their economic life were replaced.

TABLE SHOWING WORK CARRIED OUT DURING YEAR ENDED 31/12/72

Place	Purpose	Type of Work	Construction	No. of Bores	Footage
Watheroo Line	Groundwater Investigation	Rotary drilling	Dept. of Mines	9	4,137
Eneabba Line	Groundwater Investigation	Rotary drilling	Dept. of Mines	4	2,133
Millstream	Groundwater Investigation	Cable tool and diamond drilling. Bore testing	Dept. of Mines	4	728·25
Gnangara Sand Beds	Groundwater Investigation	Removing casing and screens	Dept. of Mines	3
Cooya Pooya	Groundwater Investigation	Diamond drilling	Dept. of Mines	1	173·5
Bunbury Harbour	Foundation Investigation	Bore testing	Dept. of Mines	1
Joondalup	Groundwater Investigation	Soft strata sampling and diamond drilling	Dept. of Mines	25	243·54
Pt. Hedland Indus- trial Bore	Groundwater Investigation	Rotary and cable tool drilling	Dept. of Mines	7	404·28
West Pilbara Dam- sites	Damsite Investigation	Bore testing	Dept. of Mines	1
Canning Basin	Groundwater Investigation	Rotary drilling	Dept. of Mines	2	130
Fitzgerald River	Lignite Investigation	Auger drilling	Dept. of Mines	6	316·1
Roleystone Tunnel	Tunnel Investigation	Diamond drilling	Contractor	6	275·52
Totals—					
Drilling				298	9,857·43 (32,331 feet)
Testing				5	

BOARD OF EXAMINERS

FOR MINE MANAGER'S AND UNDERGROUND SUPERVISOR'S CERTIFICATES

W. J. Cahill—Secretary

Herewith I submit the Annual Report on the activities of the Board of Examiners for the year, 1972.

Mining Law Examination

There was only one examination held on April 17, 1972, as there were insufficient applications to warrant an additional examination being held in October. Details of the examination held were:—

Entries	8
Admitted	8
Pass	7
Did not sit	1

The names of the successful candidates were:—

- R. G. T. Garnsey
- G. Meiklejohn
- P. R. Tyson
- R. A. C. Williams
- J. R. Grieves
- W. J. Holly
- M. L. Houston.

Underground Supervisor's Examination

The written examination was held on September 4, 1972 and applications were received from the following centres:—

Kalgoorlie	31
Norseman	1

The results were as follows:—

Passed	16
Fail	14
To repeat Mining Law in 1973	2

Certificates of Competency have been issued to the successful candidates as follows:—

Kalgoorlie:

- W. R. Bennett
- T. Bryndzej
- E. B. Compton
- R. Fletcher
- J. P. Glegghorn
- W. J. Griffiths
- G. J. Kennedy
- A. Laube-Muraszko
- R. J. Leggerini
- K. McVittie
- E. A. Norris
- H. A. Stirling
- R. J. Thomson
- A. Trevisiol
- E. J. Watson
- J. W. H. Weidyk

Mine Manager's Certificates

The following were successful applicants for Mine Manager's Certificates of Competency:—

First Class

- G. V. Parker
- A. C. Cruickshank
- M. Quick
- P. R. Coates
- T. Tennant
- J. R. McDougall
- R. A. C. Williams
- J. R. Grieves
- R. M. Smith
- M. L. Houston
- D. D. Mainwaring
- N. R. Hooker

General

Five meetings were held during the year on February 4 (special in Perth), March 21, May 10, July 25 and October 4.

During the year the Board of Examiners visited Kalgoorlie to examine candidates orally for the Underground Supervisors examination. The Norseman candidate was examined at Kalgoorlie.

DIVISION III

Report of the Superintendent of State Batteries—1972

Under Secretary for Mines:

For the information of the Hon. Minister for Mines, I submit my report on the operations of the State Batteries for the year ending 31st December, 1972.

Crushing Gold Ores

One 20 head, four 10 head, and nine 5 head mills crushed 44,135½ tons of ore made up of 302 separate parcels, an average of 146.14 tons per parcel. The bullion produced amounted to 13,434 oz. which is estimated to contain 11,386 oz. of fine gold equal to 5 dwt. 4 grn. of gold per ton of ore. The average value of the ore after amalgamation, but before cyanidation, was 1 dwt. 21 grn. Thus the average head value of the ore was 7 dwt. which is 15 grn. less than the previous year's average.

A total of 52½ tons of tungsten ore was also crushed at plants that crush mainly gold ores. The average cost for crushing the 44,188½ tons was \$11.56 per ton, compared with 1971 when 28,360½ tons were crushed at a cost of \$14.48 per ton.

Cyaniding

Four plants treated 12,757 tons of tailings from amalgamation for a production of 1556 fine oz. of gold. The average content was 3 dwt. 7 grn. before cyanidation, while the residue after treatment averaged 20 grn. The theoretical extraction was, therefore, 74.51%. The actual extraction was 74.09%. The cost of cyaniding was \$7.17 per ton, which was less than the previous year, when 12,241 tons were treated at a cost of \$8.56 per ton.

Silver recovered by the cyanidation of gold tailings amounted to 97.15 fine oz. valued at \$115.10.

TREATMENT OF ORES OTHER THAN GOLD

Lead Ores

During the year the Northampton State Battery crushed 2,486½ tons of lead ore with an average content of 8.84% lead and 1.61% zinc. There were 9 separate parcels giving an average of 276½ tons of ore per parcel.

A total of 239.25 tons of concentrates were produced. The concentrates averaged 68.6% lead and 2.33% zinc, giving an estimated content of 164.21 tons of lead and 5.58 tons of zinc in concentrates.

2,247 tons of tailings were discarded. These had an average content of 2.47% lead and 1.54% zinc, giving a total of 55.48 tons of lead and 34.53 tons of zinc discarded in tailings. The recovery in the concentrates was 74.7% of the lead and 13.9% of the zinc in the ore delivered to the plant.

The cost of operating the Northampton State Battery, including administration, was \$30,773.94, being \$12.38 per ton of ore crushed. Revenue received was \$5,009.86, being \$2.02 per ton. The corresponding figures for 1971 when 1160½ tons of ore were crushed, were operating cost \$35,866.29 being \$30.91 per ton, and revenue \$2,601.26 being \$2.24 per ton.

Tin Ore

No tin ore was crushed for the year but the Marble Bar magnetic separator plant treated 2.75 tons concentrates for a recovery of 3,516 lb of high grade tin concentrates valued at \$3,100.

Tantalite—Columbite Ores

The Marble Bar magnetic separator plant recovered 124 lb of high grade tantalite concentrates valued at \$400.

Tungsten Ore

The Boogardie State Battery treated 52½ tons of Wolfram ore from which 1,067 lb of Tungsten concentrates valued at \$900 were recovered.

Value of Production

The estimated value of production from the State Batteries since their inception, excluding the value of gold tax paid to the Commonwealth is:

	GOLD		Grand Total
	1972	\$	
Par Production—			
Crushing	96,729		18,377,789
Cyanidation	13,222		4,516,497
Gold Premium—			
Crushing	259,083		13,028,782
Cyanidation	35,350		3,550,727
Open Market Premium—			
Crushing	159,803		322,045
Cyanidation	21,845		70,306
Total Gold Production	\$586,032		\$39,866,146

OTHER ORES REALISED

	1972	Grand Total
	\$	\$
Silver	115	4,178
Tin—		
Ores and Concentrates	3,100	472,790
Residues		1,144
Tungsten Concentrates	900	40,266
Agricultural Copper Ore		11,932
Lead Concentrates	42,900	1,432,034
Tantalite-Columbite Concentrates	400	73,121
Total Other Ores	\$47,415	\$2,035,465
Grand Total	\$833,447	\$41,901,611

FINANCIAL

	Tons	Expenditure	Receipts	Loss
		\$	\$	\$
Crushing—Gold Mills	44,188.5	510,657	40,375	470,282
Magnetic Separator Plant—				
Marble Bar	2.75	625	160	465
Crushing Lead Mill—Northampton	2,486.25	30,774	5,010	25,764
Cyaniding	12,757	91,421	23,232	68,189
		633,477	68,777	564,700

The loss of \$564,700 is an increase of \$65,466 on the previous year. It does not include depreciation and interest on capital.

Capital expenditure all from Consolidated Revenue Fund, was incurred as follows:

		\$
Boogardie	Repair Ramp and Ore Bin	1,185
Coolgardie	Repair Stamp Mill and Mill Building	7,331
Kalgoorlie	Repair supports for Stamp Mills and Fine Ore Bins	3,799
Laverton	Repairs to Battery	235
Marble Bar	Changeover to A.C. Power	2,577
Yarri	Install Jaw Crusher, Conveyor and Bin	4,345
		\$19,472

Cartage Subsidies

	<i>Tons</i>	<i>Cost</i>
Ore carted to State Plants	23,304	\$32,713

Comparative Figures for the last three years are:

Year	State Plants				Private Plants		
	Tons Crushed	Tons Subsidised	% Subsidised	Cost	Tons Subsidised	Cost	Total Cost
1970...	23,264½	12,450½	44.05	\$22,815	Nil	Nil	\$22,815
1971...	23,547½	15,241½	51.58	22,321	Nil	Nil	22,321
1972...	46,677½	23,304	49.93	32,713	Nil	Nil	32,713

Administrative

Expenditure amounted to \$89,113.27 equivalent to \$1.50 per ton of ore crushed and cyanided, compared with an expenditure of \$87,668.47, \$2.10 per ton, for 1971.

	1971	1972
	\$	\$
Salaries	51,088.76	49,917.31
Pay Roll Tax	11,015.05	15,092.63
Workers Compensation	18,523.32	17,367.96
Travelling and Inspection	2,543.03	3,089.51
Sundries	4,493.31	3,645.86
	\$87,668.47	\$89,113.27

Staff

During February, Electrical Technical Officer R. Williams was electrocuted while working on a high tension power line between the Coolgardie town

and the Coolgardie State Battery. Robert Williams was a very capable and popular young man and his accidental death was a sad loss to his family, State Battery staff and his many other friends.

Manager R. Stevens was transferred from Norseman to Marble Bar, and Manager McPherson from Marble Bar to Laverton.

General

From the beginning of the year to December 23rd, the price of gold obtainable by Australian producers rose by close to \$16.00 per fine oz. This big rise caused a considerable revival of activity of small gold producers, resulting in a big increase in the amount of gold ore crushed at State Batteries, from 27,985½ tons in 1971 to 44,135½ tons in 1972. Most goldfields were affected, including some that had produced very little gold for many years. Late in the year it was decided to repair the Laverton State Battery which had been idle since 1959. This plant will be ready to operate in early 1973. The revaluation of the Australian dollar on December 23rd, caused some reduction in the Australian price of gold, but this price is still high and a further increase in the amount of gold ore crushed at State Batteries is expected next year.

Only four cyanide plants operated during 1972, the tonnage treated being only slightly higher than in the previous year. Most of the increased gold ore crushed was fairly low grade with low grade amalgamation tailings, but the amount of tailings requiring cyanide treatment is increasing at some Batteries, and it is probable that more cyanide plants will operate in 1973.

There was also an increase in the amount of lead ore crushed at the Northampton Battery. Most of this increase was in the last few months of the year, and it is likely that this plant will be fairly active next year.

There were very little minerals other than gold or lead recovered. A small parcel of tungsten ore was crushed at Boogardie and the Marble Bar magnetic plant treated only a small amount of alluvial tin concentrates.

The increased gold and lead ore crushed caused an increase in State Battery expenditure, but resulted in a big decrease in the cost per ton crushed, from \$15.20 in 1971 to \$11.61 in 1972.

K. M. PATERSON,
Superintendent State Batteries.

Schedule No. 1

NUMBER OF PARCELS TREATED, TONS CRUSHED, GOLD YIELD BY AMALGAMATION AND HEAD VALUE FOR THE YEAR ENDED 31st DECEMBER, 1972

Number of Parcels Treated	Battery	Tons Crushed	Yield by Amalgamation				Amalgamation Tailings Content		Contents of Ore-Fine Gold			
			Bullion		Fine Gold				Total		Per Ton	
			Oz	Dwt	Oz	Dwt	Oz	Dwt	Oz	Dwt	Dwt	Grn
6	Boogardie	295.75	48	12	41	4	77	17	119	1	8	1
44	Coolgardie	3,415.00	1,534	15	1,300	14	410	1	1,710	15	10	0
50	Kalgoorlie	15,170.00	5,203	19	4,410	7	832	6	5,242	13	6	22
10	Lake Darlot	1,116.00	119	17	101	11	149	0	250	11	4	12
30	Leonora	2,859.50	848	18	719	9	472	6	1,191	15	8	8
23	Marble Bar	1,757.00	1,160	10	991	3	588	9	1,529	12	17	10
34	Marvel Loch	5,014.50	1,369	9	1,160	12	513	18	1,674	10	6	16
24	Meekatharra	4,133.00	528	4½	447	14	363	12	811	6	3	22
10	Menzies	923.75	664	15	563	8	102	0	665	8	14	10
25	Norseman	1,292.00	838	12	710	14	218	16	929	10	14	9
24	Ora Banda	6,986.25	759	12	643	15	311	11	955	6	2	18
4	Paynes Find	317.00	67	4	56	19	25	12	82	11	5	5
5	Sandstone	268.00	125	8	106	5	47	7	153	12	11	11
13	Yarri	588.00	155	15	132	0	38	12	170	12	5	19
302		44,135.75	13,434	10½	11,385	15	4,101	7	15,487	2	7	0

Average Tons per Parcel 146.14
 Average Yield by Amalgamation per ton (Fine Gold) 5 dwts. 4 grn.
 Average Value of Tailings per ton (Fine Gold) 1 dwt. 21 grn.

Schedule No. 2

DETAILS OF EXTRACTION TAILINGS TREATMENT 1972

Battery	Tons Treated	Head Value		Tail Value		Calculated Recovery		Actual Recovery		
		Per Ton	Total content	Per Ton	Total content	Oz.	%	Oz.	%	
		Dwt.	Grn.	Dwt.	Grn.	Oz.	%	Oz.	%	
Kalgoorlie	3,450	2	16	0	16	112.90	346.30	75.41	334.13	72.76
Leonora	5,500	3	8	0	20	234.70	678.65	74.30	679.47	74.39
Marble Bar	1,127	5	3	1	9	77.40	212.45	73.29	214.42	73.98
Marvel Loch	2,680	3	7	0	20	110.60	327.85	74.77	328.40	74.90
	12,757	3	7	0	20	535.60	1,565.25	74.51	1,556.42	74.09

Schedule No. 3

DIRECT PURCHASE OF TAILINGS FOR THE YEAR ENDED 31st DECEMBER, 1972

Battery	Tons of Tailings Purchased	Initial Payment to \$28 per Fine oz.
Boogardie	3.25	\$ 115.45
Coolgardie	1,180.25	2,768.28
Kalgoorlie	1,371.75	4,417.32
Lake Darlot	163.75	432.99
Leonora	1,556.25	4,266.01
Marble Bar	1,529.25	6,385.40
Marvel Loch	2,019.00	2,778.90
Meekatharra	193.50	83.57
Menzies	271.25	134.91
Norseman	336.25	2,173.31
Ora Banda	27.75	140.83
Sandstone	54.00	219.70
Yarri	11.75	26.30
	8,718.00	\$23,942.97

Schedule No. 4

STATEMENT OF RECEIPTS AND EXPENDITURE FOR THE YEAR ENDED 31st DECEMBER, 1972

Milling

Battery	Tons Crushed	Management and Supervision	Wages	Stores	Total Working Expenditure	Cost per Ton	Repairs and Renewals	Sundries	Gross Expenditure	Cost per Ton	Receipts	Receipts per Ton	Profit	Loss
Boogardie	458.50	\$ 10,095.69	\$ 3,195.53	\$ 1,746.48	\$ 15,037.70	\$ 44.87	\$ 1,617.93	\$ 3,461.38	\$ 20,717.01	\$ 59.44	\$ 422.33	\$ 1.21	\$	\$ 20,294.68
Coolgardie	3,415.00	11,451.51	20,964.60	4,314.76	36,730.87	10.76	5,307.26	7,007.88	49,046.01	14.36	3,568.66	1.04		45,477.35
Cue								117.74	117.74		1,879.50		1,761.76	
Kalgoorlie	15,170.00	24,708.97	38,038.50	20,163.43	82,910.90	5.46	8,954.34	33,610.87	125,476.11	8.27	10,247.32	.67		115,228.79
Lake Darlot	1,116.00	5,659.71	8,431.93	2,834.42	17,126.06	15.35	1,002.14	1,772.01	19,900.21	17.83	1,417.80	1.27		18,482.41
Laverton			324.00		324.00				324.00		510.00		186.00	
Leonora	2,859.50	5,267.34	14,333.23	7,539.79	27,190.36	9.51	2,131.56	6,359.22	35,681.14	12.48	2,824.90	.99		32,856.24
Marble Bar	1,757.00	10,897.58	10,652.79	5,026.95	26,577.32	15.13	5,133.31	5,145.69	36,856.32	20.98	2,053.85	1.17		34,802.47
Marvel Loch	5,014.50	8,430.59	24,540.58	6,861.27	39,832.44	7.94	1,588.65	9,151.05	50,572.14	10.09	5,199.01	1.04		45,373.13
Meekatharra	4,133.00	8,325.72	22,780.46	6,679.16	37,785.34	9.14	5,605.51	9,760.61	53,151.46	12.86	3,231.03	.78		49,920.43
Menzies	923.75	6,675.34	7,446.53	2,801.99	16,923.86	18.32	5,132.19	3,526.51	25,582.56	27.69	1,070.81	1.16		24,511.75
Norseman	1,292.00	8,638.12	5,757.94	2,618.50	17,014.56	13.17	1,356.20	2,995.33	21,366.09	16.54	1,418.78	1.10		19,947.31
Nullagine			653.50	14.50	668.00				668.00					668.00
Ora Banda	6,986.25	8,182.17	17,159.59	4,919.93	30,261.69	4.33	4,317.58	9,870.00	44,449.27	6.36	4,949.66	.71		39,499.61
Paynes Find	317.00	1,108.75	2,492.59	215.53	3,816.87	12.04	125.38	391.65	4,333.90	13.67	342.35	1.08		3,991.55
Sandstone	268.00	1,089.93	2,302.15	877.22	3,769.30	14.06	401.81	624.36	4,795.47	17.89	309.08	1.15		4,486.39
Yarri	588.00	3,916.74	5,847.90	1,869.85	11,634.49	19.79	5,055.09	930.50	17,620.08	29.97	867.46	1.48		16,752.62
Head Office											62.92		62.92	
Sub-Total	44,188.50	115,248.16	184,921.82	68,033.78	368,203.76	8.33	47,728.95	94,724.80	510,657.51	11.56	40,375.46	.91	2,010.68	472,292.73
Marble Bar (Magnetic Plant)	2.75		604.36		604.36	219.77	19.66	.74	624.76	227.18	160.00	58.18		464.76
Northampton	2,486.25	13,541.86	5,054.42	4,930.65	23,576.93	9.43	2,895.85	4,301.16	30,773.94	12.38	5,009.86	2.02		25,764.08
Total	46,677.50	128,790.02	190,580.60	73,014.43	392,335.05	8.41	50,644.46	99,026.70	542,056.21	11.61	45,545.32	.98	2,010.68	498,521.57

OPERATING LOSS \$496,510.89

Schedule No. 5

STATEMENT OF RECEIPTS AND EXPENDITURE FOR THE YEAR ENDED 31st DECEMBER, 1972

Cyaniding

45

Battery	Tons Treated	Management and Supervision	Wages	Stores	Total Working Expenditure	Cost per Ton	Repairs and Renewals	Sundries	Gross Expenditure	Cost per Ton	Receipts	Receipts per Ton	Profit	Loss		
Kalgoorlie	3,450.00	\$ 5,327.65	\$ 14,679.36	\$ 3,502.02	\$ 23,509.03	\$ 6.81	\$ 415.55	\$ 11,897.24	\$ 35,821.82	\$ 10.38	\$ 6,844.07	\$ 1.98	\$	\$ 28,977.75		
Leonora	5,500.00	5,685.33	8,858.14	6,296.78	20,840.25	3.79	155.40	9,431.67	30,427.32	5.53	9,963.84	1.81		20,463.48		
Marble Bar	1,127.00	3,690.42	1,589.17	5,279.59	4.68	1,617.85	6,897.44	6.12	3,926.64	3.48		2,970.80		
Marvel Loch	2,680.00	10,069.86	3,141.16	13,211.02	4.93	731.39	3,904.17	17,846.58	6.66	6,817.55	2.54		11,029.03		
Norseman	147.06	180.96	65.94	393.96	34.21	428.17		428.17		
Total	12,757.00	11,160.04	37,478.74	14,595.07	63,233.85	4.96	1,302.34	26,885.14	91,421.33	7.17	27,552.10	2.16	63,869.23		
											Interest Paid to Treasury	4,320.00	4,320.00	
														<u>91,421.33</u>	<u>23,232.10</u>	63,189.23
															Operating Loss	<u>63,189.23</u>

STATE BATTERIES

TRADING AND PROFIT LOSS ACCOUNT FOR THE YEAR ENDED 31st DECEMBER, 1972

1971		1972
\$		\$
304,217	Trading Costs—	
63,137	Wages	368,009
90,507	Stores	87,610
100,419	Repairs, Renewals and Battery Spares	51,947
	General Expenses and Administration	130,231
<hr/>		
558,280		637,797
59,046	Earnings—	
	Milling and Cyaniding Charges	73,097
<hr/>		
499,234	Operating Loss for the Year	564,700
	Other Charges—	
61,696	Interest on Capital	61,901
29,494	Depreciation	27,206
18,233	Superannuation—Employers Share	15,498
<hr/>		
109,643		104,605
<hr/>		
608,877	Total Loss for the Year	669,305

BALANCE SHEET AS AT 31st DECEMBER, 1972

31st December, 1971	Funds Employed	31st December, 1972
\$		\$
1,471,920	Capital—	
322,195	Provided from General Loan Fund	1,471,570
	Provided from Consolidated Revenue Fund	341,666
<hr/>		
1,794,115		1,813,236
	Reserves—	
57,244	Commonwealth Grant—Assistance to Gold Mining Industry	57,244
27,572	Commonwealth Grant—Assistance to Metalliferous Mining	27,572
<hr/>		
84,816		84,816
2,575,308	Liability to Treasurer—	
	Interest on Capital	2,637,209
	Other Funds—	
7,034,396	Provided from Consolidated Revenue Fund (Excess of payment over collections)	7,599,005
<hr/>		
11,488,635		12,134,266
	Deduct—	
	Profit and Loss :	
10,602,764	Loss at Commencement of Year	11,211,641
608,877	Loss for Year	669,305
<hr/>		
11,211,641	Total Loss from Inception	11,880,946
<hr/>		
276,994		253,320

Employment of Funds

	Fixed Assets—	
1,782,932	Plant, Buildings and Equipment	1,802,053
1,540,892	Less Depreciation	1,568,098
<hr/>		
242,040		233,955
	Current Assets—	
17,372	Debtors	26,278
82,327	Stores	83,484
9,627	Battery Spares	11,368
	Purchase of Tailings :	
27,096	Treasury Trust Account	20,854
70,665	Tailings not treated	76,543
12,460	Estimated Gold Premium	8,708
<hr/>		
219,547		227,235
<hr/>		
461,587	Total Assets	461,190
	Deduct—	
	Current Liabilities :	
26,702	Creditors	38,598
143,669	Liability to Treasurer (Superannuation—Employers Share)	159,167
	Purchase of Tailings :	
1,762	Creditors	1,397
12,460	Estimated Premium Due	8,708
<hr/>		
184,593		207,870
<hr/>		
253,320		253,320

DIVISION IV

Annual Report of the Geological Survey Branch of the Mines Department for the Year 1972

CONTENTS

	Page
INTRODUCTION	51
STAFF	51
OPERATIONS	52
Hydrology and Engineering Geology Division	52
Sedimentary (Oil) Division	52
Regional Geology Division	53
Mineral Resources Division	54
Common Services Division	54
ACTIVITIES OF THE COMMONWEALTH BUREAU OF MINERAL RESOURCES	55
PROGRAMME FOR 1973	55
PUBLICATIONS AND RECORDS	56

REPORTS

HYDROLOGY

1. Exmouth water supply ; by J. R. Forth 57
2. Hydrogeology of a calcrete deposit on Paroo Station, Wiluna, and surrounding areas ; by C. C. Sanders 61

SEDIMENTARY GEOLOGY

3. Stratigraphic nomenclature of Cretaceous rocks in the Perth Basin ; by A. E. Cockbain and P. E. Playford 72
4. Petroleum exploration in Western Australia in 1972 ; by G. H. Low 77
5. Petroleum development and production in Western Australia in 1972 ; by R. N. Cope 86

MINERAL RESOURCES

6. Tests of a prototype 3MHz electromagnetic method ; by N. Watanabe and J. L. Baxter 90
7. Silica-rich pillow lavas near Soansville, Marble Bar 1 : 250,000 sheet ; by S. L. Lipple.... 98
8. The North Pole barite deposits, Pilbara Goldfield ; by A. H. Hickman 103

PETROLOGY

9. The petrology of an ultramafic lava near Murphy Well, Eastern Goldfields, Western Australia ; by J. D. Lewis and I. R. Williams 106

GEOCHEMISTRY

10. A guide to the geochemistry of nickeliferous gossans and related rocks from the Eastern Goldfields ; by R. H. A. Cochrane 115
11. A pilot study of phosphorus distribution in parts of the Brockman Iron Formation, Hamersley Group, Western Australia ; by R. C. Morris 121

ENVIRONMENTAL GEOLOGY

12. The geology of the Fitzgerald River lignite ; by A. E. Cockbain and W. J. E. van de Graaff 127

LIST OF FIGURES

Figure No.	Page
1. Index map showing areas and localities described in Annual Report for 1972	49
2. Progress of 1:250,000 or 4-mile geological mapping at the end of 1972	53
3. Exmouth water supply location and topographic map	58
4. Diagram of freshwater wedge with zone of diffusion and scale of TDS variation from Cape Range to the sea on section A-A ¹ , shown on Figure 3	59
5. Paroo Station project, Wiluna. Paroo and Yandil catchment areas	62
6. Paroo Station project, Wiluna. G.S.W.A. exploratory water bores, position and geological map	63
7. Relationship of rock units north-south through Paroo Sub-basin	65
8. Sketch maps of W.A. showing areal distribution of calcrete and Middle Proterozoic sediments	66
9. Paroo Station project, Wiluna. Diagrammatic cross sections, Paroo calcrete aquifer	68
10. Cretaceous stratigraphic nomenclature, Perth Basin	73
11. Wells drilled for petroleum exploration in W.A. during 1972	79
12. Wells drilled for petroleum exploration in the northern Carnarvon and southern Canning Basins to the end of 1972	80
13. Petroleum tenements at 31st December, 1972	81
14. Barrow Island area. Windalia reserves	87
15. Monthly gas production from the Dongara and Mondarra Fields, 25th October, 1971, to 31st December, 1972	88
16. Production licence No. 3, Walyering Gas Field	89
17. Monthly gas production from Walyering No. 1 and Gingin No. 1 during 1972	89
18. Northwest Shelf bathymetry and status of petroleum development	90
19. Block diagram of the prototype 3MHz prospecting equipment	91
20. Optimum operating characteristics of the 3MHz prospecting equipment	91
21. Propagating pattern of mixing wave	91
22. Examples of results	92
23. Area 1	93
24. Area 2	93
25. Area 3	94
26. Area 4	95
27. Area 5	96
28. Regional survey	97
29. Locality map of pillow lavas showing regional geology	98
30. Detailed geological map of the area surrounding the pillow lavas	99
31. Photographs of felsic pillow lavas	100
32. Photomicrographs of felsic pillow lavas in plain polarized light	101
33. Geological map of the area surrounding the North Pole barite deposits	103
34. Photographs of structures in the barite deposits	104
35. Strike frequency diagrams for T-chert in the area of the barite prospects	105
36. Locality map, Murphy Well ultramafic body	107
37. Geology of the Murphy Well area	108
38. Photomicrographs of amygdaloidal peridotite, Murphy Well	108
39. Photomicrographs of the Murphy Well peridotite lava	109
40. Electron probe scan across relict olivine grain in 26652	112
41. Western Australia—Eastern Goldfields with locations of nickel mineralization	116
42. Photographs of a gossan, a false gossan and a laterite	116
43. Reagent applicator for large scale stain printing of core	124
44. Phosphate distribution in parts of the Dales Gorge Member, Hole 47 at Wittenoom	124
45. Phosphate distribution in parts of the Dales Gorge Member, Hole 47 at Wittenoom	125
46. Photographs of Brockman Iron Formation drill core with stratigraphically equivalent phosphate stain prints	126
47. Photographs of Brockman Iron Formation drill core with stratigraphically equivalent phosphate stain prints	127
48. Phosphate distribution in stratigraphically equivalent samples of the Dales Gorge Member from widely separated areas	127
49. Fitzgerald River area—locality map	128
50. Fitzgerald River area—geological map	129
51. Stratigraphic correlation of drillholes and distribution of lignite	130
52. Fence diagram showing correlation of drill-holes	131
53. Areal extent of Werillup Formation beneath river-terrace alluvium	132
54. Diagram showing factors affecting distribution of lignite	133

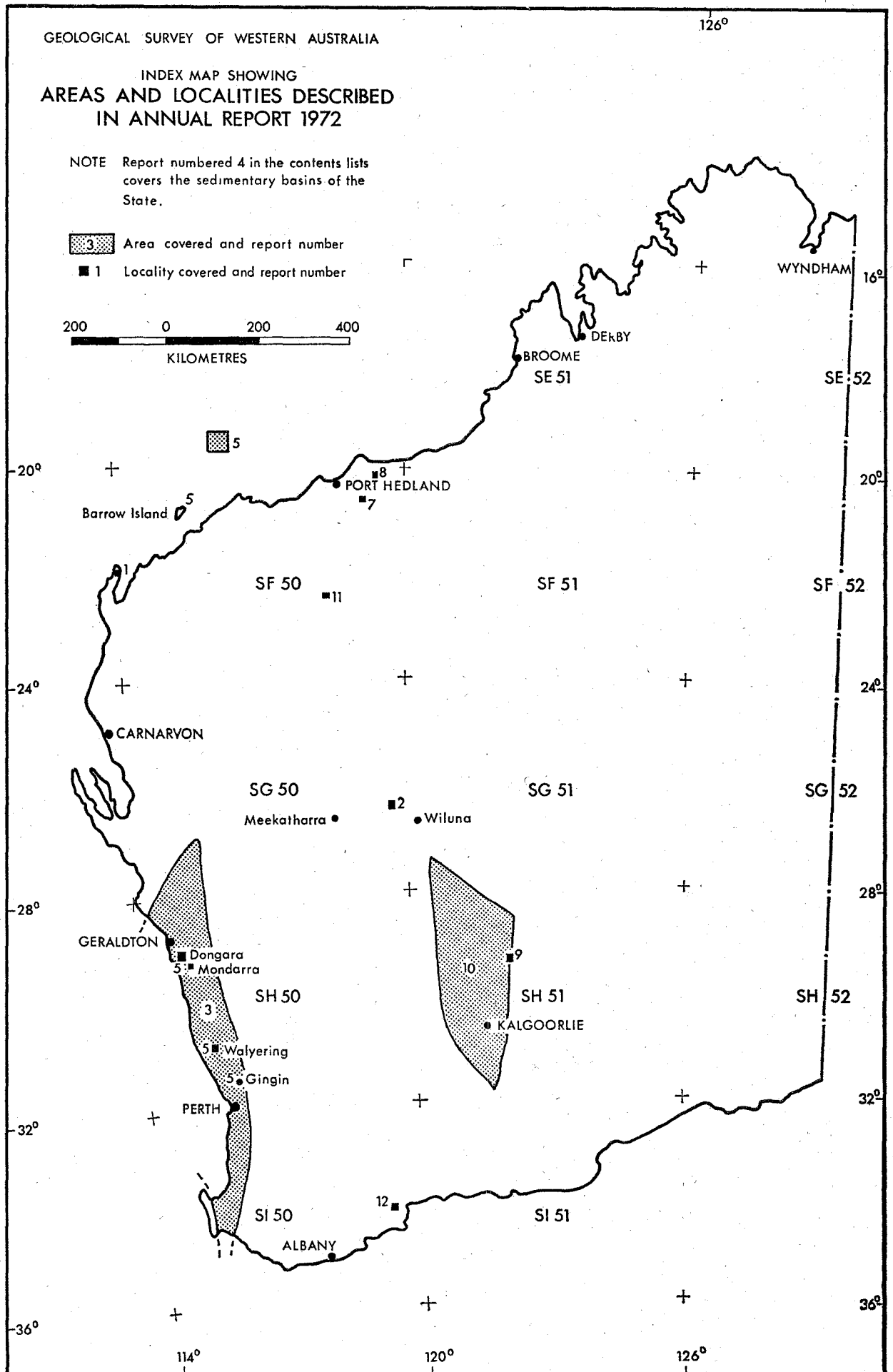

Figure 1. Index map showing areas and localities described in Annual Report for 1972.

DIVISION IV

Annual Report of the Geological Survey Branch of the Mines Department for the Year 1972

The Under Secretary for Mines

For the information of the Honourable Minister for Mines, I submit my report on the activities of the Geological Survey of Western Australia during 1972, together with some of the reports on investigations made for departmental purposes.

INTRODUCTION

During 1972 the decline in exploration activity ceased and stability returned to the scene. In fact, by the end of the year there was thought to be an improvement in activity, which will be assisted by a decision to allow Temporary Reserves for all minerals to be taken up again in areas where there is no intense exploration or prospecting activity.

The development of our major deposits of iron, bauxite and nickel are still delayed because of the depressed nature of metal prices and the over-supply position on the world markets. There is a hope that the position may improve during the next year.

Exploration for iron ore was stepped-up with the granting of new Temporary Reserves last May while the feasibility studies of such deposits as McCamey's Monster, Rhodes Ridge and others continued. Goldsworthy Mining Ltd. announced the proving of reserves of 510 million t of ore with a grade of 62.5 per cent Fe and 0.06 per cent phosphorus situated in their area C about 300 km south of Port Hedland.

Exploration for bauxite has almost ceased as there are three projects with proven reserves, namely Amax (Mitchell Plateau, North Kimberley), Pacminex (Chittering area north of Perth) and Alwest (northeast of Bunbury) waiting for a recovery in the demand for alumina.

Exploration for nickel continues although plans to open some mines such as Carr Boyd, Spargoville, Widgiemooltha, Redross and Wannaway have been suspended for the present. Exploration has outlined additional reserves on known deposits such as Kambalda with 22,770,000 t containing 3.29 per cent nickel and Agnew 34 million t containing 2.2 per cent nickel. A number of new occurrences have been reported which are still being examined. Two of promise are near Forrestania, 160 km south-southeast of Southern Cross and a low-grade occurrence near Roebourne.

The tempo of oil exploration continued to increase on the northwest shelf with further gas and oil discoveries. The Woodside-Burmah group announced a gas reserve of $566 \times 10^9 \text{ m}^3$ while one hole, Eaglehawk No. 1, produced an oil flow of 1,645 barrels per day. West Australian Petroleum Pty. Ltd. made two encouraging intersections near the end of the year in West Tryal Rocks well, where the presence of hydrocarbons was recorded over a total thickness of 46 m and a deep well on Barrow Island encountered high pressure gas at 3,218 m.

Both holes are yet to be tested and assessed. The prospects of this area are most encouraging and, although there remains a long and costly period of exploration before the extent of the gas and oil province is finally known, the final outcome will no doubt solve one of the State's major problems, that is the lack of a source of natural fuel and the resultant cheap power for industrial expansion.

There has been a keen interest in the search for uranium, particularly since Western Mining Corporation's find at Yeelirrie (80 km south of Wiluna) claimed to contain 32 million t averaging 0.15 per cent uranium oxide. The uranium occurs as secondary minerals in calcrete and is suitable for open-cut shallow mining. Another reported occurrence is at Mundong Well (290 km northeast of Carnarvon), where uranium mineralization in the form of kasolite occurs with copper and lead mineralization in a tension vein within a shear zone in a belt of metamorphic rocks which correlate with the Lower Proterozoic Wyloo Group. These two finds have given encouragement for further uranium search on which many companies are now engaged.

Exploration for coal has continued without any noticeable success. The Jurassic deposit of coal at Eneabba has been subjected to feasibility studies and found to be similar in quality to the coal at Collie, suitable for on-site power generation.

In conjunction with the exploration mentioned above the search for other minerals such as copper, lead, zinc, chromium, diamonds, mineral sands, fluorite, barite, kaolin, talc, etc. continues. Considerable interest has been aroused in the potential of lead mineralization in the Devonian limestones of the Kimberley, while several occurrences of fluorite are being examined in detail.

Two lectures followed by field excursions were arranged during the year. The first was centred on Yalgoo covering the Yalgoo and Murgoo 1 : 250,000 sheets. Over 90 persons attended. The second was centred on Ravensthorpe covering the Ravensthorpe and Lake Johnston 1 : 250,000 sheets at which over 110 persons attended. As there is a firm demand for such lectures and excursions, more will be organized during 1973.

STAFF

The staffing situation has been very stable during the year. The only resignation was that of Dr. K. Hooper who decided to return to his University position.

All vacant and new positions have been filled or committed. There are no professional vacancies at present.

It was hoped to arrange a section to deal with environmental geology, however finance was not available for the two positions proposed.

PROFESSIONAL

Appointments

Name	Position	Effective Date
Gibson, A. A., A.W.A.S.M.	Senior Geologist, L3	5/1/72
Wilde, S. A., Ph.D.	Geologist, L1	6/1/72
Cochrane, R. H. A., M.Sc.	Geochemist, L2	12/1/72
Campbell, J. M., B.Sc. (Hons.)	Geologist, L1	1/2/72
Hickman, A. H., Ph.D.	Geologist, L1	20/3/72
Gee, R. D., Ph.D.	Supervising Geologist, L5	8/6/72
Connolly, R. R.	Geologist, L1	22/9/72

Resignations

Hooper, K.	Palaeontologist	1/9/72
------------	-----------------	--------

Promotions

Cockbain, A. E.	Palaeontologist	23/8/72
-----------------	-----------------	---------

CLERICAL AND GENERAL

Butherford, P.	Geophysical Assistant	10/4/72
Branson, G.	Technical Assistant	1/8/72
Boyd, S.	Geological Assistant	25/8/72
McGilligan, M.	Geological Assistant	25/9/72
Veitch, R.	Clerk C-IV	27/11/72

Resignations

Ash, L. A.	Technical Assistant	14/4/72
Bradley, T. R.	Geological Assistant	22/12/72

Transfers In

Nichols, T. J.	Geological Assistant	23/10/72
----------------	----------------------	----------

Transfers Out

O'Rourke, G.	Geological Assistant	4/8/72
Collins, B.	Geological Assistant	13/10/72
Boyd, S.	Geological Assistant	13/11/72
Abbott, J.	Clerk C-IV	24/11/72

OPERATIONS

HYDROLOGY AND ENGINEERING GEOLOGY DIVISION

E. P. O'Driscoll (Chief Hydrogeologist), T. T. Bestow, R. P. Mather (Supervising Geologists), K. Berliat, A. D. Allen (Senior Geologists), C. C. Sanders, G. W. A. Marcos, J. R. Forth, R. E. J. Leech, W. A. Davidson, A. S. Harley, R. G. Barnes, D. P. Commander, W. P. Balleau, R. I. J. Vogwill, J. Nicholson, and J. M. Campbell.

Hydrogeology

The deep drilling along the Watheroo-Jurien Bay cross section of the Perth Basin was completed and shows that large storages of both domestic and industrial quality water exist in the Mesozoic and Quaternary sediments down to depths of at least 750 m. Drilling on another cross section between Winchester and the coast near Beagle Island has commenced.

Drilling and test pumping of the shallow aquifers of the Perth Basin, north and northwest of Perth, have been carried out by the Metropolitan Water Board and this Department. Areas investigated include Joondalup, Gwelup, Whitfords and Wanneroo. Drilling has commenced in the Lake Thomson area with a view to exploring the potential of shallow aquifers south of the Swan River. A regional assessment of the deeper aquifers of the metropolitan area is continuing.

A study is being made of the effect of drawing pressure water for industrial purposes in the Pinjarra district. It seems likely that at the present rates of use a substantial part of the water is being drawn from storage.

Consultants are continuing their investigation in the East Murchison area for several companies involved in mining feasibility studies. The estimated demand totals 140,000 m³ per day. The Geological Survey maintains close liaison with these investigations to advise the Government on progress and to further a long term regional water resources appreciation of the State.

Three bores have been drilled on a new major investigation in the Canning Basin east of Port Hedland.

Further deepening of the Cooya Pooya No. 1 borehole to 245 m showed that the groundwater is limited to gravels associated with the Harding River and the weathered section of the Proterozoic volcanics.

At Millstream deepening and test pumping five boreholes to the goethite and Wittenoom Dolomite sections below the calcretes failed to locate the

expected larger yields. In the area an investigation was made of a proposal to construct a barrage across the Fortescue River to divert flows onto the calcrete to provide recharge for the Millstream aquifers.

Engineering Geology

With staff at full strength this section has been involved almost entirely with dam site investigations. The following services were provided for the Metropolitan Water Board:

- geological advice during dam construction at South Dandalup;
- detailed investigations of the Lower Wungong dam site including mapping, seismic traverses, diamond and auger drilling and trenching;
- geological mapping for the proposed outlet tunnel from the Canning Dam.

For the Department of Works the following work was done:

- a detailed investigation of a proposed dam site at Collie;
- a preliminary reconnaissance has been made of five prospective dam sites on the Ashburton River and two on Turee Creek;
- the following sites have been studied in the Pilbara:—
 - North Pole and Lalla Rookh on the Shaw River—detailed investigation;
 - Kangan Pool on the Sherlock River—mapping and some diamond drilling;
 - Cooya Pooya on the Harding River diamond drilling;
 - Bullinnarwa Pool on the Fortescue River—field mapping commenced.

Advice was given to other Government Departments such as Railways and Main Roads on minor problems.

Near Ravensthorpe a recently discovered lineament in the form of a low scarp was examined. Arcuate in shape, and resembling that formed at Meckering in 1968, the scarp is believed to be of earthquake origin. A trench across the profile showed a development of soil and laterite which suggests the scarp is not of very recent origin.

SEDIMENTARY (OIL) DIVISION

P. E. Playford (Supervising Geologist), R. N. Cope (Production Geologist), G. H. Low (Senior Geologist), J. C. Boegli, R. W. A. Crowe, and W. J. E. van de Graaff.

Petroleum exploration and production data from companies operating in Western Australia were appraised and collated throughout the year. A report was prepared on gas reserves of the North Rankin, Goodwyn, Rankin, Angel, and Scott Reef gas and condensate fields.

Regional mapping of the Phanerozoic rocks around the southern and eastern margins of the Officer Basin was completed. Mapping was carried out on the Neale, Plumridge, Cundelee, Mingiwal, and Rason 1:250,000 sheets in this area. A drilling programme in the Officer Basin was jointly supervised by the Bureau of Mineral Resources and the Geological Survey to clarify the stratigraphy and hydrogeology.

A regional mapping project was initiated in the northeastern Canning Basin, jointly with the Bureau of Mineral Resources. Mapping of the Phanerozoic of the Billiluna, Lucas, and Stansmore sheets was completed.

Detailed mapping of the Napier Range reef complex was carried out at Windjana Gorge with geologists of the Bureau of Mineral Resources. The joint party also supervised the drilling of a number of shallow stratigraphic holes on the Lennard Shelf.

Geological mapping and test drilling were conducted in the Fitzgerald River area to determine the extent and economic prospects of the Eocene lignite known in the area.

REGIONAL GEOLOGY DIVISION

R. D. Gee (Supervising Geologist), I. R. Williams (Senior Geologist), P. C. Muhling, C. F. Gower, R. Thom, and J. A. Bunting.

The programme of regional mapping of the Precambrian area of the State for publication at a scale of 1:250,000 continued. The progress of mapping is shown in Figure 2.

GEOLOGICAL SURVEY OF WESTERN AUSTRALIA

1:250,000 OR 4 MILE GEOLOGICAL MAPPING

1972

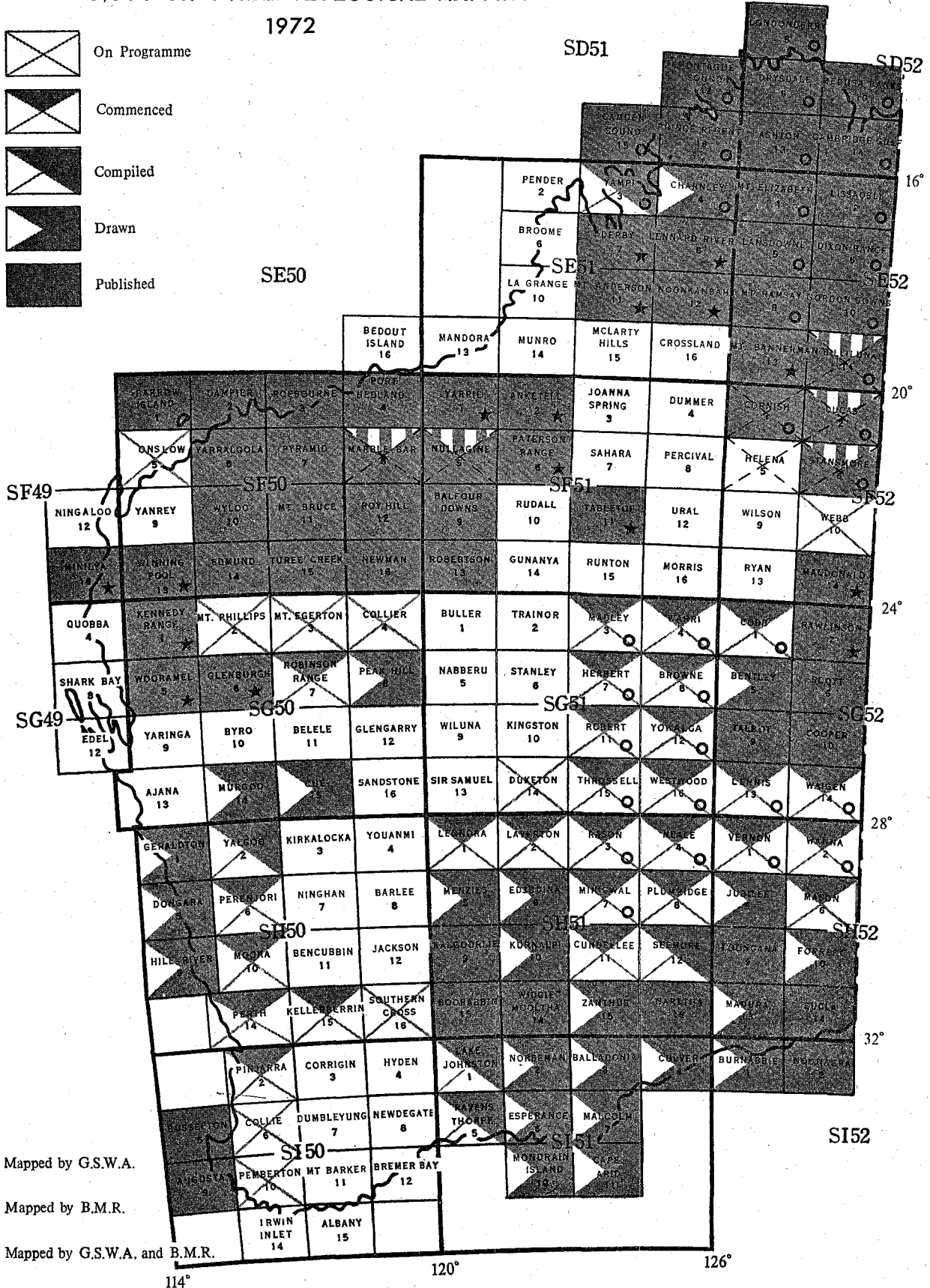

Figure 2. Progress of 1:250,000 or 4-mile geological mapping at end of 1972.

Compilation of the Ravensthorpe, Lake Johnston and Yalgoo sheets was completed. Field mapping of the Leonora, Rason, Neale, Minigwal, Plumridge and Cundelee sheets was finished. Field work on Laverton sheet was half completed.

Work continued on both the synthesis of the geology of the Eastern Goldfields, and the compilation of the Kalgoorlie and Esperance 1:1,000,000 sheets.

A joint mapping programme with the Bureau of Mineral Resources was carried out resulting in the re-mapping of the Precambrian portion of the Billiluna, Lucas and Stansmore sheets.

Geological excursions on the Yalgoo, Ravens-thorpe and Lake Johnston sheets were conducted.

MINERAL RESOURCES DIVISION

J. G. Blockley (Supervising Geologist), J. D. Carter and A. A. Gibson (Senior Geologists), J. L. Baxter, A. H. Hickman, S. L. Lippie and S. A. Wilde.

Compilation of the results of a study of the State's tin deposits continued.

Field and office work were commenced for the compilation of a bulletin on mineral sand deposits, one on vanadium, chromium, tungsten and molybdenum and a revision of the bulletin on the copper deposits of Western Australia.

Tests were carried out on the application of a prototype instrument employing a new geophysical technique for the exploration of mineral deposits; a summary of the results is included in this Report.

Re-mapping of the Marble Bar 1:250,000 geological sheet was completed and compilation is in progress.

Mapping of the Precambrian portion of the Perth 1:250,000 geological sheet is in progress in conjunction with a study of bauxite occurrences.

Other work included brief inspections of deposits of uranium, diatomite, nickel, barite, marble, fluorite and vermiculite and reports on two road alignments affecting heavy mineral sands and tin deposits.

COMMON SERVICES DIVISION

Petrology—(W. G. Libby, J. D. Lewis, and R. Peers)

The service function of the Petrology section was served by the completion of 62 petrologic reports in 1972. As an aid in the production of significant reports, petrologists continued to visit geological parties in the field and discussions between field staff and petrologists were encouraged. Sixty two petrologic reports were prepared during the year.

As in previous years chemical, mineralogical and X-ray diffraction work by the Government Chemical Laboratories has increased the effectiveness of petrologic reports.

Over 1,680 thin sections and many polished sections were prepared in addition to making sand size analyses and preparing rock samples for chemical and geochronological processing.

A study of the petrology of the sills in the Weeli Wolli Formation is continuing and a project on rodingite in the Laverton and adjacent map sheets has started. The studies of ultramafic lava of the Yundamindra area and alkali syenite of Peak Charles are being completed.

The establishment of a computer-based data storage system has progressed slowly but steadily. Simple input forms now accompany all material submitted for petrologic work and forms for most thin sections described in past petrologic reports have been partly completed, allowing the systematic filing of nearly 3,000 backlogged thin sections.

The need for a quantitative input to the data system has necessitated the development of a standard igneous and metamorphic rock classifica-

tion for the section. A by-product of this effort hopefully will be clearer communication between petrology and field staff.

The co-operative geochronological programme with the Western Australian Institute of Technology continued through 1972 with the completion of field and laboratory work on several projects in the Gascoyne and Pilbara areas. Liaison and co-operation with the geochronological staff of the Australian National University continued through the year.

Palaeontology—(A. E. Cockbain, J. Backhouse and K. Grey)

During the year 105 file reports were written. As can be seen from the accompanying statistical breakdown of the reports routine palynological work for the Hydrology Division continued to occupy much of the laboratory's time.

Reports written for :	Field of Palaeontology		
	Paly-nology	Micro-palaeontology	Macro-palaeontology
Hydrology and Engineering Geology Division ...	69	14	1
Sedimentary (Oil) Division ...	7	3	3
Other ...	1	2	3
Outside organizations ...	0	0	0

For most of the year the palynology of samples from the Watheroo Line bores was studied; this work should help considerably in our understanding of the biostratigraphy of the Upper Mesozoic in the Perth Basin. About 9 weeks were spent with a joint G.S.W.A./B.M.R. party in the Canning Basin, collecting Devonian fish from the Gogo Formation and doing well site geology. The study of the Devonian brachiopods collected from the Lennard Shelf area by the Survey over the past few years was continued.

Prior to his departure in August, Dr. Hooper completed a preliminary survey of Cretaceous planktonic foraminifers from the Perth and Carnarvon Basins. Dr. Cockbain was transferred to the Palaeontology Section as officer in charge.

Geophysics—(D. L. Rowston and I. R. Nowak)

Geophysical investigation for the Hydrology and Engineering Division again dominated activities, and as predicted there was a greater demand for seismic refraction work on engineering projects. Surveys were carried out at the South Canning and Lower Wungong dam sites and the Canning Tunnel portals. Additionally, four dam sites at Collie and in the Pilbara were contracted out to geophysical consultants.

Resistivity soundings and seismic refraction techniques were tested at 21 sites in the west Canning Basin to evaluate their application in a regional study of groundwater potential. Whilst the value of the refraction work was clearly demonstrated the significance of the resistivity results is problematical. This investigation will be extended in 1973 and the geophysical interpretation tested by drilling. Velocity inversion problems were encountered in refraction shooting to determine the depth to Archaean basement in another survey in the Port Hedland townsite.

The acquisition of two Gearhart Owen logging units permitted a substantial increase in water bore logging operations. Seventy bores in the Port Hedland region, 21 in the Officer Basin and 60 in the Perth Basin were logged. The number of bores, 151 (43 in 1971), resulted in a total logged length for all runs of 31,600 m compared with 24,000 m in 1971. Depths of the bores ranged between 50 and 760 m.

Laboratory services included 500 conductivity measurements on field water samples, calibration of field salinity bridges and normal maintenance of electronic equipment and instruments.

Geochemistry—(R. H. A. Cochrane)

A programme of reconnaissance scale regional geochemical mapping involving rock and stream sediment sampling was commenced in the Eastern Goldfields. This project was broken into three parts:

- (a) a preliminary survey to collect samples regionally throughout the Eastern Goldfields to enable evaluation of the geochemical background. As part of this study samples were collected from most of the areas of known nickel mineralization in the Eastern Goldfields.
- (b) this was followed by an orientation stream sediment survey of the Leonora and Laver-ton 1:250,000 sheets to determine the most suitable size fractions for more detailed follow-up work. Early evaluation of these orientation results indicated the suitability of the Leonora sheet for a more detailed survey.
- (c) the more detailed survey was commenced in August and the evaluation of the results is continuing.

Technical Information—(J. H. Thom, M. M. Harley, S. J. Commander and S. M. Fawcett)

The library continues to be used extensively by the public. It is estimated that 2,164 such persons availed themselves of the facilities during 1972 and 142 loans were made, while loans to departmental staff amounted to 7,207.

Requisitions raised for photo-copying for the public of out-of-print publications numbered 905. Many requisitions were for several items. Requisitions raised on the Surveys and Mapping Branch for drafting services and photography for the Survey totalled 994.

Twenty-six Records were prepared and issued during the year, while preparation of manuscripts and proof reading of items mentioned in the list of publications below continued. In addition the usual service to public and staff inquiries was given. The development of the Geological Museum continues, and small parties from schools are now being given escorted tours.

**ACTIVITIES OF THE COMMONWEALTH
BUREAU OF MINERAL RESOURCES**

The geological and geophysical projects carried out by the Bureau of Mineral Resources in Western Australia included the following:

- (i) Compilation of the 1:250,000 geological sheets and bulletins on the Kimberley Division as a joint project with the Survey.
- (ii) Completion of the helicopter gravity survey of the State.
- (iii) Completion of geological mapping of the Officer Basin as a joint venture with the Survey including seismic surveys and drilling.
- (iv) Commencement of geological mapping of the Canning Basin on the Billiluna, Lucas and Stansmore 1:250,000 sheets as a joint project with the Survey.
- (v) Combined investigation with the Survey of the late Devonian rocks in the Bugle Gap to Oscar Range area including shallow stratigraphic drilling.
- (vi) Continuation of the aeromagnetic survey of W.A.

PROGRAMME FOR 1973

HYDROLOGY AND ENGINEERING DIVISION

A. Hydrology

1. Continuation of the hydrogeological survey of the Perth Basin including deep drilling.
2. Hydrogeological investigations and/or exploratory drilling for groundwater in the following areas:
 - (a) Pilbara-Millstream, Cooya Pooya and Fortescue River
 - (b) West Canning Basin
 - (c) Murchison and East Murchison—regional assessments
 - (d) Town water supplies for the following: Esperance, Cape Le Grand.
3. Hydrogeological investigations for Metropolitan Water Board:
 - (a) Regional studies
 - (b) Deep drilling at Whitfords, Mirrabooka, Gwelup and Wanneroo
 - (c) Shallow drilling at Wanneroo and Lake Thomson.
4. Kimberley Division—hydrogeological assistance to pastoralists as required.
5. Continuation of bore census work in selected areas.
6. Miscellaneous investigations and inspections as requested by Government departments and the public.

B. Engineering

1. Pilbara area—further investigations at the following dam sites: North Pole, Kangan Pool, Cooya Pooya, Bullinarwa and probably Gregory Gorge and Munni Creek.
2. Ashburton area: geological mapping of three sites if staff available.
3. Murchison area—field reconnaissance.
4. Darling Range area—continuation of work on South Dandalup, South Canning, Lower Wungong and Collie dam sites—commencement of work on the Harvey River and/or Burekup dam sites.

SEDIMENTARY (OIL) DIVISION

1. Maintain an active interest in the progress and assessment of oil exploration in Western Australia.
2. Evaluate oil and gas discoveries and assess the resources of the State.
3. Continue the sub-surface study of the Perth Basin and the completion of the Bulletin.
4. Continuation of compilation of the mapping of the Officer Basin and begin preparation of the Bulletin.
5. Continue studies of the Devonian of the Canning Basin.
6. Commence surface and sub-surface study of the Carnarvon Basin.
7. Mapping of the Canning Basin in conjunction with the Bureau of Mineral Resources.

REGIONAL GEOLOGY DIVISION

1. Compilation of the Leonora, Rason, Neale, Plumridge, Minigwal, Cundeelee, Marble Bar, Billiluna, Lucas and Stansmore 1:250,000 sheets.

2. Continuation of the mapping of the Laverton 1:250,000 sheet.
3. Commencement of mapping of the Bangemall Basin on the Mount Egerton, Collier and Mount Phillips 1:250,000 sheets.
4. Re-assessment of the regional geology of Eastern Goldfields.
5. Commencement of the mapping of the Precambrian on the Throssell and Duketon 1:250,000 sheets.

MINERAL RESOURCES DIVISION

1. Completion of mineral resources bulletins on the tin deposits and mineral sands deposits of Western Australia.
2. Re-map the Nullagine 1:250,000 sheet.
3. Regional mapping of the Darling Range on 1:250,000 scale and study of bauxite occurrences.
4. Assessment of vanadium, chromium, tungsten and molybdenum deposits of Western Australia.
5. Revision of mineral resources bulletin on copper deposits.
6. Miscellaneous mineral investigations as required.

PUBLICATIONS AND RECORDS

Issued during 1972

Annual Report, 1971.

Bulletin 122: The geology of the Western Australian part of the Eucla Basin.

Geological map of Cooper 1:250,000 Sheet (SG/52-10 International Grid) with explanatory notes.

Geological map of Eucla-Noonaera 1:250,000 Sheet (SH/52-14 and SI/52-2 International Grid) with explanatory notes.

Geological map of Medusa Banks 1:250,000 Sheet (SD/52-10 International Grid) with explanatory notes.

Geological map of Montague Sound 1:250,000 Sheet (SD/51-12 International Grid) with explanatory notes.

Geological map of Scott 1:250,000 Sheet (SG/52-6 International Grid) with explanatory notes.

Geological map of Talbot 1:250,000 Sheet (SG/52-9 International Grid) with explanatory notes.

In Press

Bulletin 123: The geology of the Blackstone Region, Western Australia.

Report 2: A reappraisal of the Yule River area: Port Hedland Town water supply, and an appraisal of the effects of long-term pumping in the Lake Allanooka area.

Mineral Resources Bulletin 9: The lead, zinc and silver deposits of Western Australia.

Geological map of Balladonia 1:250,000 Sheet (SI/51-3 International Grid) with explanatory notes.

Geological map of Bentley 1:250,000 Sheet (SG/52-5 International Grid) with explanatory notes.

Geological map of Culver 1:250,000 Sheet (SI/51-4 International Grid) with explanatory notes.

Geological map of Cue 1:250,000 Sheet (SG/50-15 International Grid) with explanatory notes.

Geological map of Esperance-Mondrain Island (SI/51-6 and 10 International Grid) with explanatory notes.

Geological map of Forrest 1:250,000 Sheet (SH/52-10 International Grid) with explanatory notes.

Geological map of Geraldton 1:250,000 Sheet (SH/50-1 International Grid) with explanatory notes.

Geological map of Jubilee 1:250,000 Sheet (SH/52-5 International Grid) with explanatory notes.

Geological map of Kurnalpi 1:250,000 Sheet (SH/51-10 International Grid) with explanatory notes.

Geological map of Madura-Burnabbie 1:250,000 Sheet (SH/52-13, SI/52-1 International Grid) with explanatory notes.

Geological map of Menzies 1:250,000 Sheet (SH/51-5 International Grid) with explanatory notes.

Geological map of Norseman 1:250,000 Sheet (SI/51-2 International Grid) with explanatory notes.

Geological map of Peak Hill 1:250,000 Sheet (SG/50-8 International Grid) with explanatory notes.

Geological map of Zanthus 1:250,000 Sheet (SH/51-15 International Grid) with explanatory notes.

In Preparation

Special publication: The geology of Western Australia.

Geological maps 1:250,000 with explanatory notes, the field work having been completed: Billiluna, Browne, Cundeelee, Herbert, Kingston, Lennis, Leonora, Lucas, Madley, Marble Bar, Mason, Minigwal, Neale, Plumridge, Rason, Ravensthorpe, Robert, Seemore, Stanley, Stansmore, Vernon, Waigen, Wanna, Warri, Westwood, Yalgoo, Yowalga.

Records Produced

1972/1 Non-metallic industrial rocks and minerals of W.A., by S. J. Commander and J. L. Baxter.

1972/2 Wells drilled for petroleum exploration in W.A. to the end of 1971, by G. H. Low.

1972/3 Reconnaissance survey of the Pilbara Region, W.A., for limestone, aggregate and clay, by J. L. Baxter.

1972/4 South Canning proposed dam site—report on preliminary geological investigations, by G. Marcos (restricted).

1972/5 Geological inspection of North Pole dam site, Shaw River, by R. P. Mather (restricted).

1972/6 A report on the geology of site E, Collie River storage investigations, by J. Nicholson (restricted).

1972/7 Hydrogeology of the Paroo Calcrete and surrounding areas, Wiluna district, W.A., by C. C. Sanders.

1972/8 Millstream calcrete aquifers, assessment and storage, by J. R. Forth (restricted).

- 1972/9 Results of investigation into groundwater resources along the lower Gascoyne River for Carnarvon irrigation and town water supplies, by A. D. Allen (restricted).
- 1972/10 Explanatory notes on the Phanerozoic rocks of the western part of the Collie 1:250,000 Sheet, W.A., by G. H. Low.
- 1972/11 Agaton project, Perth Basin—geology and groundwater at the Agaton exploratory bore field, by J. R. Passmore and P. Balleau (restricted).
- 1972/12 Explanatory notes on the Lake Johnston 1:250,000 geological sheet, W.A., by C. F. Gower and J. A. Bunting.
- 1972/13 Geological reconnaissance of dam sites nos. 2 and 3 on Turee Creek, by R. P. Mather (restricted).
- 1972/14 North Gnangara sand beds aquifer, by P. Balleau (restricted).
- 1972/15 Derby town water supply, by R. E. J. Leech (restricted).
- 1972/16 Exmouth water supply, by J. R. Forth (restricted).
- 1972/17 Millstream area, proposed artificial recharge, by W. A. Davidson (restricted).
- 1972/18 Desert farms area, Wiluna—preliminary appraisal of salinity and groundwater movement, by C. C. Sanders (restricted).
- 1972/19 Explanatory notes on the Phanerozoic rocks of the western part of the Pemberton 1:250,000 geological sheet, W.A., by G. H. Low.
- 1972/20 Explanatory notes on the Proterozoic and Phanerozoic rocks of the Perenjori 1:250,000 geological sheet, W.A., by G. H. Low.
- 1972/21 Explanatory notes on the Proterozoic and Phanerozoic rocks of the Moora geological sheet, W.A., by G. H. Low.
- 1972/22 The natural gas reserves of the Northwest Shelf of W.A. as at 30th September, 1972—an interim report, by R. N. Cope (confidential).
- 1972/23 Field tests of a prototype 3MHz electromagnetic method in W.A., by N. Watanabe and J. L. Baxter.
- 1972/24 Geological reconnaissance of dam sites on the Ashburton River, by R. P. Mather (restricted).
- 1972/25 The geology of the proposed North Pole dam site, Shaw River, by J. Nicholson and J. M. Campbell (restricted).
- 1972/26 Explanatory notes on the Seemore 1:250,000 geological sheet, W.A., by W. J. E. van de Graaff.

Reports in other publications

- De Laeter, J. R., and Blockley, J. G., 1972, Granite ages within the Archaean Pilbara Block, Western Australia: *Geol. Soc. Australia Jour.* v.19, pt 3.
- Mountjoy, E. W., and Playford, P. E., 1972, Submarine megabreccia debris flows and slumped blocks of Devonian of Australia and Alberta—a comparison: *Am. Assoc. Petroleum Geologists Bull.*, v.56, p.641.
- Playford, P. E., and Cockbain, A. E., 1972, Geopetal fabrics: important aids for interpreting ancient reef complexes: *Am. Assoc. Petroleum Geologists Bull.* v.56/3.
- Playford, P. E., Wray, J. L., and Cockbain, A. E., 1972, Devonian algal stromatolites from Canning Basin, Western Australia: *Am. Assoc. Petroleum Geologists Bull.* v.56/3.
- Trendall, A. F., 1972, Revolution in earth history: *Geol. Soc. Australia Jour.* v.19, pt.3.

J. H. LORD,
Director.

31st January, 1973.

EXMOUTH WATER SUPPLY

by J. R. Forth

ABSTRACT -

The Public Works Department have drilled 41 water supply bores in very hard cavernous limestone on the eastern flank of the Cape Range anticline, west of Exmouth Gulf. Above not very permeable Mandu marly limestone, potable water ranging between 500 and 1,500 ppm TDS occurs in the form of a wedge with its upper surface just above sea level, and in contact eastwards with the sea.

The bore field is probably being operated at a safe production rate, and most of the individual bores are being under pumped. However, the recording of pumped salinities will not give sufficient warning if the system is likely to fail, and a set of observation bores to monitor the fresh/saline groundwater interface should be established.

Annual throughflow at the bore field (8,000 m in length) is estimated at 1.35×10^8 m³/year and it is suggested that annual abstraction should not be allowed to exceed 0.81×10^8 m³/year if satisfactory water quality is to be maintained.

The maximum safe pumpage rate for an individual bore depends upon the particular aquifer hydraulic characteristics of each site, and methods are available for this to be approximately calculated for any bore site once a specific capacity test has been done.

Bore spacings are satisfactory in the present bore field, but if the field is extended the bore spacing could probably be reduced to as little as 300 m as long as total pumpage is kept at a safe level.

INTRODUCTION

Exmouth town is 1,200 km north of Perth and is on the eastern side of North West Cape (Fig. 3), a peninsula 21 km from east to west and some 96 km in length. Along its axis a simple anticlinal structure of Tertiary limestones forms Cape Range, bounded on its eastern and western flanks by a flat coastal plain approximately 1.5 km wide.

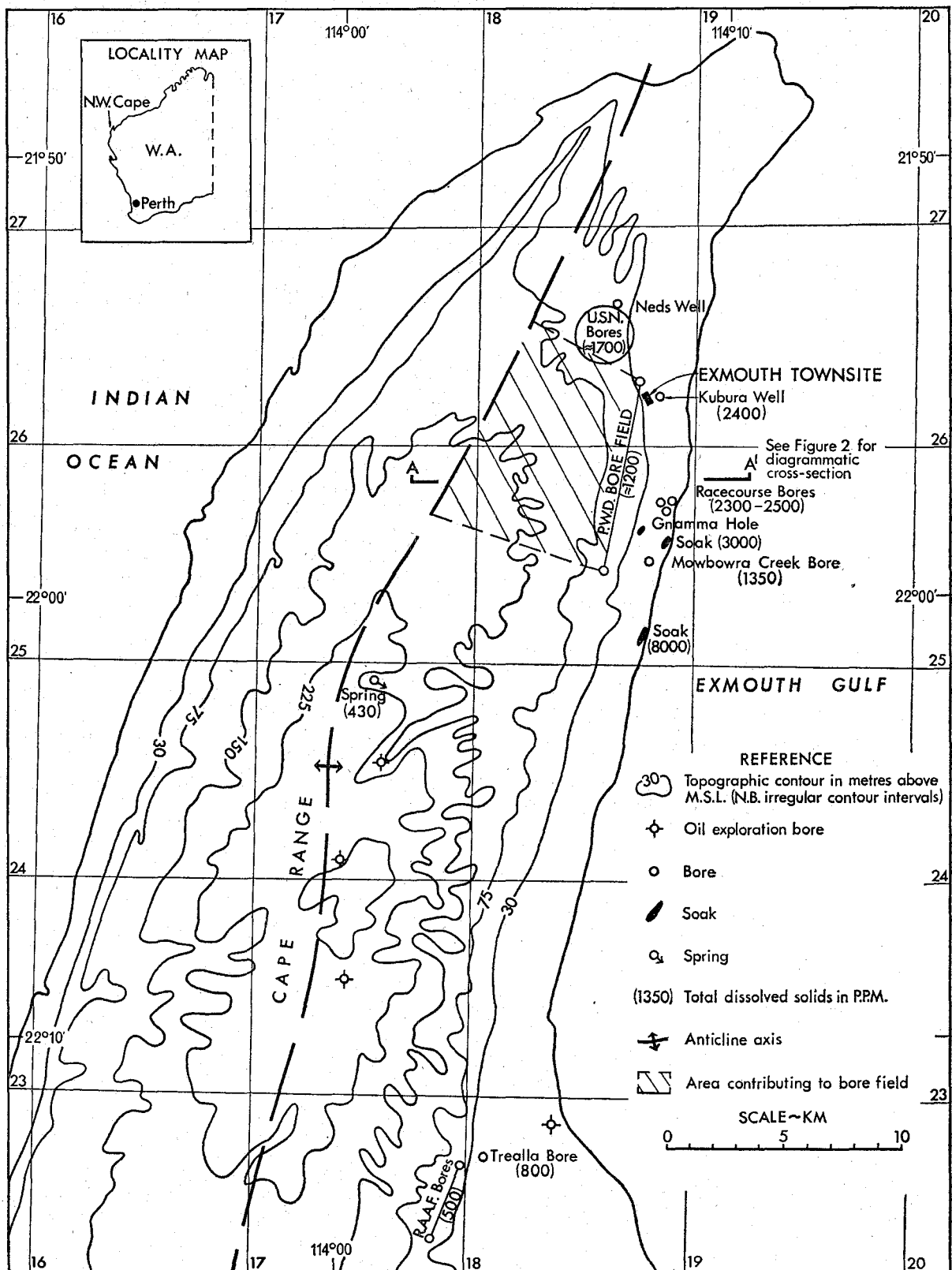

Figure 3. Exmouth water supply location and topographic map.

Maximum elevation is slightly more than 300 m. Stream courses are deeply incised and dendritic in pattern with flat surface divides separating very steep sided canyons.

The present water supply is from bores drilled into cavernous limestone to the west of Exmouth town. Except for one or two bores, water quality has so far been satisfactory, but because some fears have been held for the possible contamination of the supply by saline water from upconing below individual bores, bore salinities and water levels have been monitored.

The only hydraulic information is from specific capacity tests of the production bores.

This report investigates three main problems:

- (1) The maximum permissible yield for any individual bore
- (2) The maximum total pumpage that can be maintained for the existing bore field
- (3) Future data collection to overcome present inadequacies.

Previous work by Sofoulis (1949), Condon and others (1953), O'Driscoll (1963) and Bestow (1966) has been utilized as well as drillers' logs and production records kept by the Public Works Department. These detailed records are described in a fuller report which is not publicly available (Forth, 1972).

GEOLOGY

A general stratigraphic sequence for rocks cropping out in the Cape Range area is as follows:

Age	Formation	Lithology
Recent	Bundera Calcarenite	Clastic limestone
	Mowbowra Conglomerate	Limestone conglomerate
Pleistocene	Exmouth Sandstone	Calcareous sandstone

UNCONFORMITY

?Pliocene	Upper Yardie Group	Calcareous sandstone
Miocene	Lower Yardie Group	Calcareous sandstone
Miocene	Trealla Limestone	Crystalline limestone

DISCONFORMITY

Miocene	Tulki Limestone	Crystalline limestone
Miocene	Mandu Calcarenite	Foraminiferal clastic limestone

The well field is on the eastern flank of Cape Range where the Mandu, Tulki and Trealla limestones occur.

The *Mandu Calcarenite* is chalky and friable and over 100 m thick, its upper part only cropping out in very deeply incised canyons. In the lowest exposures it is a fine-grained massive calcarenite and marl, contrasting with its porous chalky nature elsewhere. This variation is of hydrological significance as the marly lower portion could provide a barrier to the downward percolation of rainwater. The only known perennial spring in the Cape Range emerges at the contact between the lower marly rock and the overlying coarse chalky rock.

The *Tulki* and *Trealla Limestones* are very alike, both formations being thick bedded, very hard, crystalline and cavernous. The top of the Tulki Limestone is marked by a band of pisolitic ferruginous limestone.

The Tulki Limestone is 65 m thick at the type section and the Trealla Limestone is 35 m.

Structurally Cape Range is a simple plunging anticline with limestone cropping out above the 30 m topographic contour. Below this level are Pleistocene and Recent sediments. Cavernous flow occurs below the surface and can be seen at the

gnamma hole, south of the town, and at Kubura Well. On the plains flanking the anticline, recharge is probably restricted to the drainage lines.

HYDROLOGY

The groundwater is replenished from the annual rainfall (254 mm). Recharge is by direct percolation through the limestone and also by downward soakage through the gravelly stream beds. It appears to ride above the lower marly and impermeable part of the Mandu Calcarenite, a base which has the same anticlinal form as the Cape Range itself. The groundwater is unconfined and has a very flat gradient.

Bore water from the Public Works Department bores typically has a TDS content of 1,000 to 1,200 ppm, with a NaCl content of 700 to 800 ppm and a hardness of around 400 ppm (calculated as CaCO_3). The salt content increases towards the sea and is greater at the northern end of the range than at the southern end.

The salinity pattern indicates rainfall recharge and groundwater flow from the range towards the coast. Variation in groundwater salinity is being caused by three independent processes: diffusion or mixing with the seawater; evapotranspiration; and solution.

DIFFUSION

In a cavernous limestone, the seawater/freshwater interface is rarely found as a distinct line of demarcation, as it would be in a uniformly porous and permeable aquifer, but will occur as an irregular zone, broadest near the coastline where the tidal influence is greatest, and narrower and less irregular away from the sea.

The varying bore salinities probably result from irregularities in the zone of diffusion, the groundwater being some 50 m below natural surface at the bore field, so that variations are more unlikely to be due to evapotranspiration. Tidal effects are observable in the bores, so a broad zone of diffusion would be expected, made more complex by the variable hydraulic properties of the cavernous limestone.

The deep saline water can be expected to have a TDS content of 40,000 ppm. Water samples from a spring within Cape Range and from the RAAF bores at Learmonth had TDS contents of about 500 ppm. An infusion of only 2 per cent of the saline water would result in a mixed water salinity of approximately 1,300 ppm which is within the observed TDS variation (600 to 2,300 ppm) at the bore field. Nearer the coast, even higher salinities are likely in pumping bores (Fig. 4).

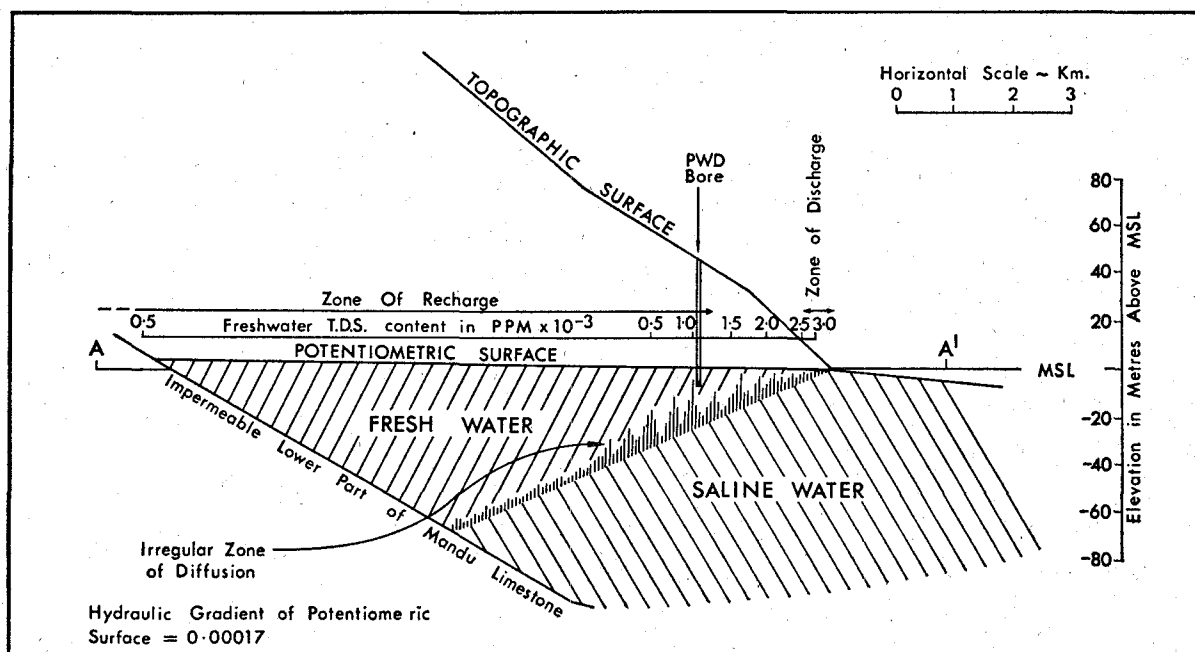

Figure 4. Diagram of freshwater wedge with zone of diffusion and scale of TDS variation from Cape Range to the sea, on section A-A', shown on Figure 3.

EVAPOTRANSPIRATION

Evapotranspiration effects would be restricted to a strip about 500 m wide parallel to the coastline, where salinities of 2,000 to 3,000 ppm have been recorded.

SOLUTION

The groundwater flow is through soluble carbonate rocks, but although the salinity will at first increase towards the discharge zone at the coast, equilibrium will be reached quickly because of the high solubility of these rocks, and there may not be a very noticeable trend of increasing salinity with distance.

Of the three processes discussed, diffusion is the most significant to the P.W.D. bore field and is probably the cause of the variations in salinity in the bores.

AQUIFER RECHARGE

Recharge to the area contributing to the P.W.D. bore field has been estimated by two methods, neither being very reliable because of data inadequacy, but yielding comparable results. Applying Darcy's Law to the data available gives the annual increment from rainfall as 25 mm/year, or 9.8 per cent of the annual rainfall. Assuming a sodium chloride content of 25 ppm for rainfall, the annual recharge comes to 9.8 per cent of the rainfall, the two figures being in remarkably close agreement. This implies that annual recharge can reasonably be accepted as being slightly less than 10 per cent.

BORE FIELD DESIGN AND OPERATION

The safe permanent operation of the bore field depends on three things: the maximum permissible pumpage for any individual bore must not be exceeded or upconing of the underlying saline water will result; pumping from one bore must not cause interference and undue draw down at neighbouring bores; the total output from the whole scheme must not exceed some yet to be determined "safe yield," which must be less than total annual throughflow.

Using formulae given by Bennett and others (1968), calculations suggest that the present rates of pumping from Bores 7, 20, L and R are probably marginal, but all other bores would be classified as quite safe and are being operated below their maximum permissible pumpages. Bennett and others (1968) derived their equations for alluvial sediments and not for cavernous limestone, which casts some doubt on the validity of using the equations, but the most important factor used is the density difference between the pumped water and the underlying saline water, and this is not a property of the aquifer material.

Results obtained by using the Theis (1935) equation to calculate interference drawdowns were also satisfactory, indicating that interference between neighbouring bores will be negligible.

Total pumpage from the bore field must be maintained at some level less than annual throughflow, otherwise the seaward flow will be so reduced that the thickness of the freshwater wedge down-gradient from the bore field will steadily decline. If this decline were allowed to proceed too far, salt water upconing would eventually occur.

From the available data the upward limit to the amount of throughflow that can be pumped cannot be calculated with any accuracy. With better aquifer hydraulic data and a good potentiometric map it would be possible, by flow net analysis, to establish the safe upward limit to total pumpage.

As this cannot be done an estimate only can be made, and this is put in the range of 60 to 70 per cent of annual throughflow.

Annual throughflow has been calculated at 1.35×10^6 m³/year, and "safe yield" is tentatively put at $0.6 \times 1.35 \times 10^6 = 0.81 \times 10^6$ m³/year.

From the data available, the present rate of abstraction (approximately 0.7×10^6 m³/year) is judged to be safe, and could be slightly increased.

From specific capacity tests a mean value of 170 m/d has been calculated for the lateral hydraulic conductivity (Table 1), which is feasible for cavernous limestone. Any errors in its estimation will directly affect estimates of recharge, "safe yield" and maximum permissible pumpage. The very wide variation in the tested values (10 to 1,000 m/d) indicate that further pump testing for other than specific capacity information will not be worthwhile because of this wide variation.

TABLE 1. CALCULATION OF HYDRAULIC CONDUCTIVITY

(See Walton, 1962, Figs. 2 to 8)

Bore	Pump Rate m ³ /d	Draw-down m	Screen Length m	T m ² /d/m	K ₁ m/d
1	125.5	0.126	2.7	900	330
3	125.5	0.254	2.7	405	150
4	125.5	0.051	2.4	2450	1000
5	125.5	0.051	2.7	2450	910
6	125.5	0.051	2.7	2450	910
7	130.9	1.36	1.7	65	24
8	130.9	0.91	2.7	106	39
9	130.9	0.61	2.7	156	58
11	130.9	0.91	3.4	106	31
13	130.9	0.76	2.7	130	48
14	130.9	0.305	6.1	350	57
15	130.9	0.71	6.1	140	23
16	130.9	0.15	4.6	780	170
17	130.9	0.76	6.1	130	21
20	130.9	1.22	6.1	75	12
21	130.9	0.455	6.1	230	38
23	130.9	0.61	5.5	160	29
J	130.9	0.305	6.1	350	57
K	130.9	0.06	6.1	2150	350
L	130.9	1.52	6.1	59	10
M	130.9	1.22	6.1	75	12
N	130.9	0.61	6.9	156	23
O	130.9	0.152	6.1	770	130
P	130.9	0.253	6.1	430	70
Q	130.9	0.28	6.1	390	64
R	130.9	1.52	6.1	59	10
T	130.9	0.38	6.1	280	46

$$rw = 0.076 \text{ m} \quad t = 0.33 \text{ days} \quad T = 585 \quad \bar{K} = 171$$

$$\bar{K} = 170$$

NOTE: K₁ = lateral hydraulic conductivity.
m³/d = cubic metre per day.
T = time.
rw = bore radius.

Absolute values of vertical hydraulic conductivity are not required for the estimation of maximum permissible yield. Vertical hydraulic conductivity is certain to vary widely as does the lateral component. A conservative ratio of 10 for lateral to vertical hydraulic conductivity can be used when calculating maximum permissible pumpage for any bore.

FUTURE INVESTIGATIONS

Bores will vary so widely in their individual behaviour that it will not be worthwhile to investigate problems associated with individual bores. The hydraulic properties of the karstic aquifer will similarly vary and it is not recommended that investigations be made to collect hydraulic data for a theoretical solution to management problems.

Instead, future work should be directed solely towards obtaining suitable data to enable the bore field to be adequately monitored and managed, the critical parameters being the position of the interface, and the groundwater levels.

POSITION OF INTERFACE

Monitoring of the position of the interface in observation bores is the most important management tool. Interface movement (as distinct from upconing below an individual bore) will be slow, and if the field is overpumped sufficient warning can be expected to allow the scheme to be expanded. The observation bores should be drilled in lines of three or four at right angles to the coast line, with each bore being drilled to approximately 30 m below sea level, capped, and with a concrete collar to exclude surface runoff.

Two lines of bores are recommended for monitoring the existing bore field, and a third to monitor the interface position where it is undisturbed by pumping.

The same bores could be used for measuring groundwater levels, to establish hydraulic gradients, and for correlation with interface movement. Because hydraulic gradients and changes in water levels are small accuracy of not more than ± 5 mm is needed.

The effects of changes in water level will not be obvious. Using present data it has been calculated that a change in water level of 75 mm (which could not be determined with the present instrumentation) would result in a reduction in freshwater storage of almost 20 per cent.

ADDITIONAL SUPPLIES

Production from the present bore field can be slightly increased, but if future monitoring indicates overpumping, the present line of bores should be extended farther south with a bore spacing of no less than 300 m. When the seawater-freshwater interface position is better known screen designs could be improved to allow higher safe pumping rates.

At present some bores are not used because of high salinity. This is thought to have resulted from localized upward diffusion of more saline water and redrilling about 100 m away might be worthwhile.

RECOMMENDATIONS AND CONCLUSIONS

1. Present total pumpage apparently is at a safe level.
2. Most individual bores are probably being underpumped.

3. Insufficient data are available to be positive about conclusions 1 and 2.

4. Monitoring of the scheme should be improved, both as regards water levels and salinities. Salinity monitoring will only reveal when the system has failed and not give sufficient warning before failure. Bores should be installed to measure changes in the interface position, and in water levels. A salinity logger would be useful for this work.

5. No investigations to collect further hydraulic data seem worthwhile, because of the obvious wide variation in aquifer properties.

REFERENCES

- Bennett, G. D., Mundorff, M. J., and Amjad Hussain, S., 1968, Electric-analog studies of brine coning beneath freshwater wells in the Punjab region, West Pakistan: U.S. Geol. Survey Water-Supply Paper 1608-J.
- Bestow, T. T., 1966, Reappraisal of groundwater prospects at Exmouth township for the Department of Public Works: West. Australia Geol. Survey Hydro. Rept. No. 300 (unpublished).
- Condon, M. A., Johnston, D., and Perry, W. J., 1953, The Cape Range structure, Western Australia: Australia Bur. Mineral Resources, Bull. 21.
- Forth, J. R., 1972, Exmouth water supply: West Australia Geol. Survey Rec. 1972/16 (restricted).
- O'Driscoll, E. P., 1963, Report on groundwater prospects Exmouth township: West. Australia Geol. Survey Hydro. Rept. No. 46 (unpublished).
- Sofoulis, J., 1951, Notes on water supply, Exmouth Gulf area: West. Australia Geol. Survey Ann. Rept., 1949.
- Theis, C. V., 1935, The relation between the lowering of piezometric surface and the rate and duration of discharge of a well using groundwater storage: Am. Geophys. Union Trans. 16th Ann. Meeting, pt. 2.
- Walton, W. C., 1962, Selected analytical methods for well and aquifer evaluation: Illinois State Dept. Registration and Education, Bull. 49.

HYDROGEOLOGY OF A CALCRETE DEPOSIT ON PAROO STATION, WILUNA, AND SURROUNDING AREAS

by C. C. Sanders

ABSTRACT

Calcrete is a valley-fill limestone deposit occurring in the arid interior of Western Australia. In places it forms excellent aquifers. One such aquifer on Paroo Station, has been explored by drilling and pump testing, which has indicated that up to 3.62×10^6 m³/year of potable water may be pumped from the area without reducing the volume

of water in storage, provided that normal recharge takes place. This annual value is the rate of downstream groundwater discharge, but natural losses by evapotranspiration and lateral underflow into the confining rocks at the margins of the calcrete constitute an additional discharge estimated to be 0.87×10^6 m³/year. These losses would be reduced, if not eliminated, if a total of 4.49×10^6 m³/year of

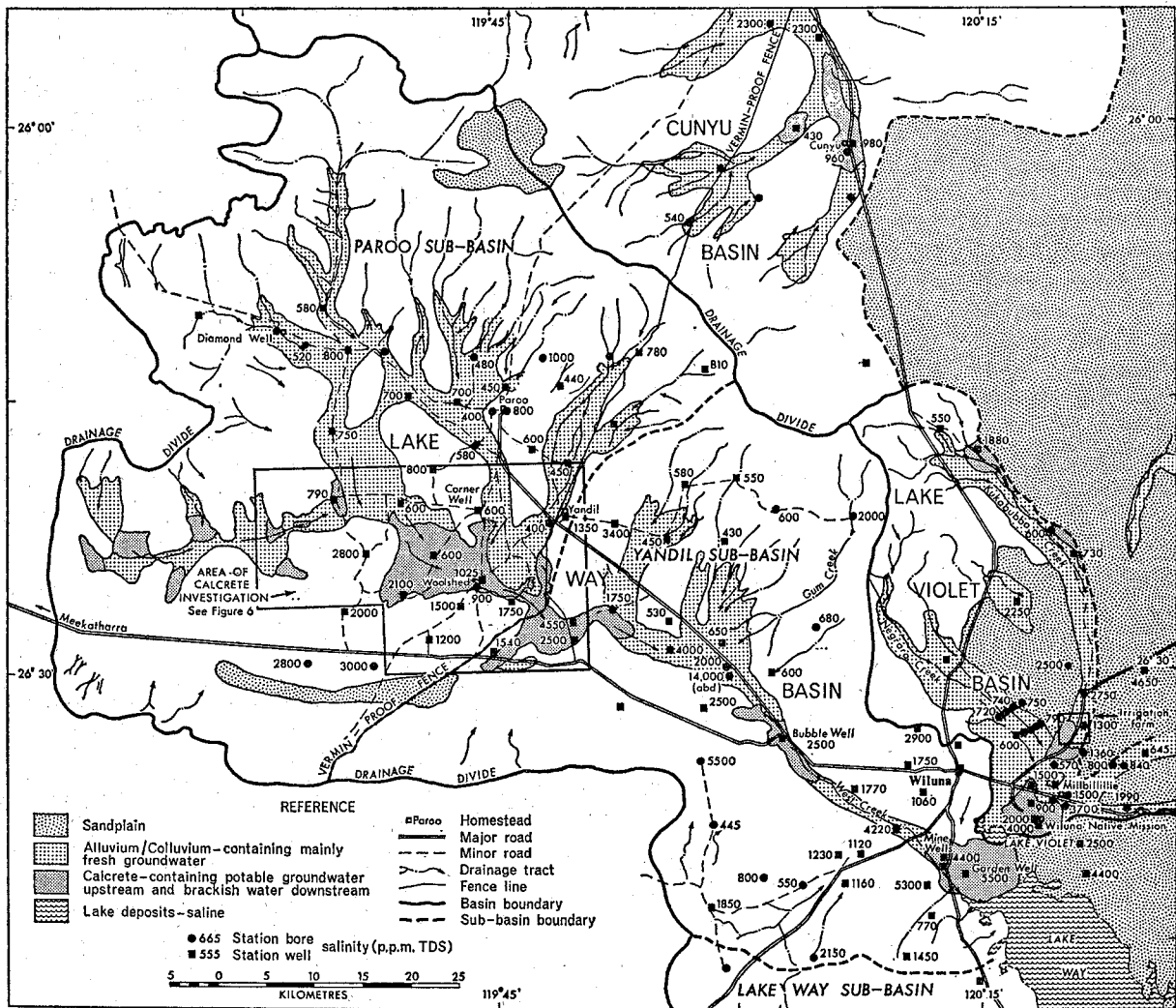

Figure 5. Paroo Station project, Wiluna. Paroo and Yandil catchment areas.

water were to be abstracted. Groundwater in storage in the aquifer has been estimated to be $104.4 \times 10^6 \text{ m}^3$. Recharge occurs directly by the infiltration of rainfall on to the calcrete and indirectly from runoff on to the aquifer from the surrounding basement rock and alluvial catchment area of $2,300 \text{ km}^2$. Other calcretes in the Wiluna district, although not tested, may be exploited for brackish industrial quality groundwater, the reserves of which could be substantial. Uranium and thorium enrichment in the calcrete is noted.

INTRODUCTION

A calcrete on Paroo Station, 56 km west of Wiluna, occupies part of a $2,300 \text{ km}^2$ catchment area, the Paroo Sub-basin of the vast Lake Way Basin that is drained internally into saline Lake Way, south of Wiluna (Fig. 5). The full Lake Way catchment area is $5,000 \text{ km}^2$. Its drainage valley is some 100 km in length and from 1 to 10 km in width, being broadest on Paroo Station, where the calcrete fill is best developed and the contained groundwater less saline than elsewhere. The terminal salt lake is at an inland base level of 490 m above mean sea level, and acts as an evaporative basin. The drainage divides for the system are in Proterozoic rocks at an average height of 580 m above mean sea level.

Paroo Station straddles the Meekatharra-Wiluna Road immediately west of the No. 1 Vermin Proof Fence, on the Glengarry 1:250,000 International Grid Sheet.

The investigation of the calcrete was undertaken as part of a broad programme to delineate areas of usable groundwater in the Wiluna district. It was already known (Ellis, 1953; Chapman, 1962) that large supplies of potable or near-potable water could be extracted from calcrete, and since the rapid expansion of mining activities in the region between Kalgoorlie and Wiluna had caused an increased draw on the established Goldfields Water Supply Scheme, an alternative scheme was warranted. At Wiluna, records show that for a 13-year period of peak gold mining operations, about $4.5 \times 10^3 \text{ m}^3$ of potable water were pumped daily from wells in calcrete, without any apparent serious aquifer depletion.

Following a hydrogeological reconnaissance of calcrete in the East Murchison Goldfield District in 1968 (Sanders, 1969), the Geological Survey undertook the drilling and testing of the calcrete on Paroo Station, which is the largest feature of its kind in the district. For the investigation, 16 bores were drilled, some with associated observation wells, in and about the calcrete (Fig. 6). Ten of the bores were pump-tested at yields of up to $1.3 \times 10^3 \text{ m}^3/\text{d}$, for 8 hours duration. This work has been previously reported (Sanders, 1971).

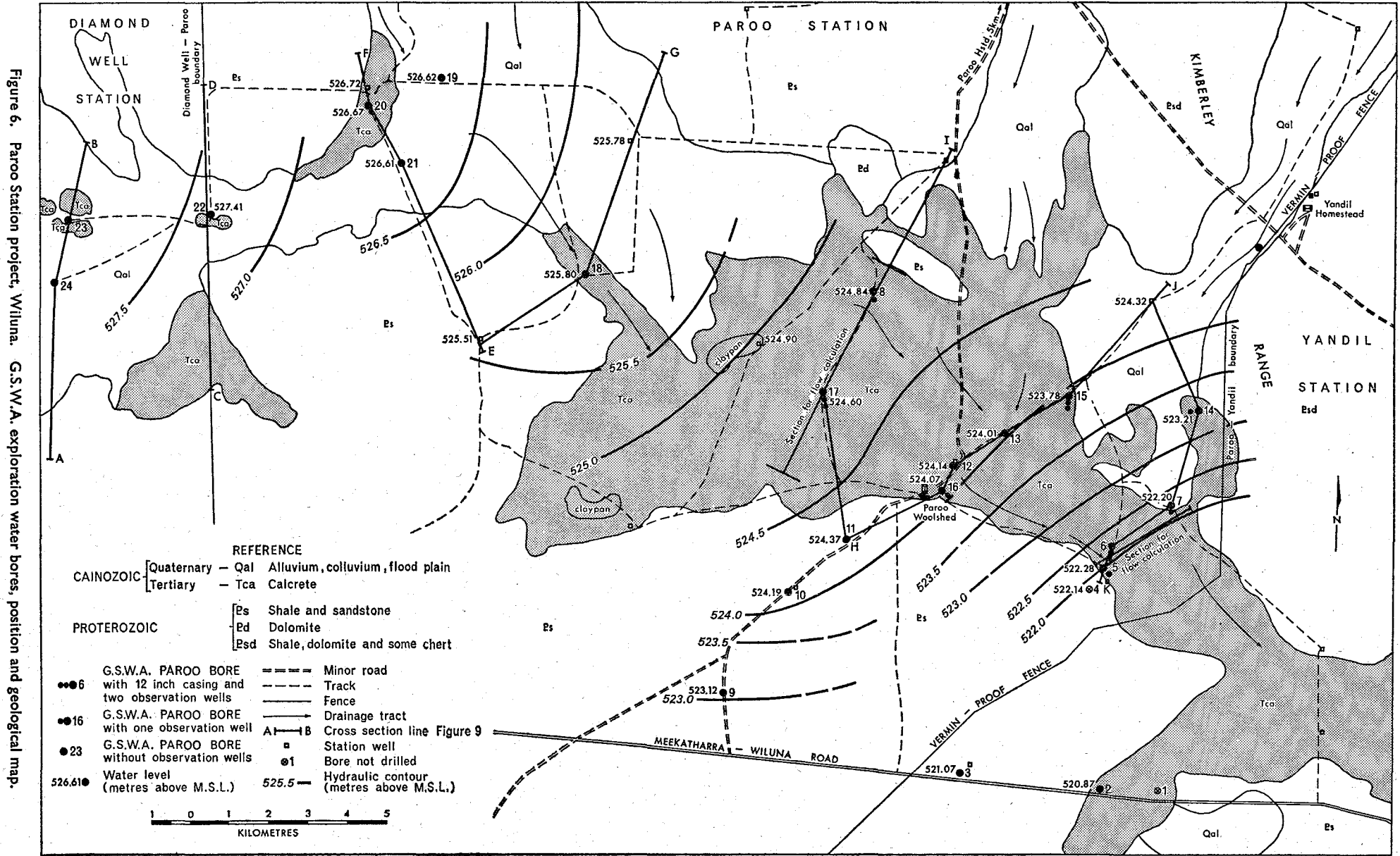

Analysis of the pumping test data indicated that a precise evaluation of the calcrete aquifer parameters could not be made without further testing of some of the bores at higher pump yields of up to 3.3×10^8 m³/d, and for durations up to 16 days. This work was undertaken in 1971 after three bores (6, 15 and 17) had been reamed out to take 12-inch standard casing, which was slotted from the standing water level to the base of the aquifer. Two fully penetrating observation wells were also constructed at each test site. Some additional drilling was also done in the northwestern part of the valley (bores 19 to 24), in an area only partly calcreted, and not previously explored.

CLIMATE AND GEOMORPHOLOGY

The climate of the Wiluna District is arid, with a mean annual rainfall at Yandil Station of 211 mm (over a 24-year period). This falls mainly between January and June (Chapman, 1962). Unreliable rainfall measurements have been made at Paroo homestead since 1966.

Evaporation rates from free water surfaces in the district are extremely high. Annual values for the East Murchison Goldfield from a British Standard 3-foot-diameter evaporimeter are between 2,286 and 2,794 mm per year.

The area lies within the Salinaland Physiographic Division of Jutson (1950), characterized by internal drainages terminating in salt lakes. The division has a general elevation of between 490 and 610 m above sea level, and forms part of the Great Plateau of Western Australia, which is developed mainly over the Archaean Yilgarn Block south of Wiluna. The plateau has a subdued relief with greatest surface expression in the Proterozoic province just north of Wiluna.

The plateau has two physiographic elements: a higher Old Plateau and a lower New Plateau (Jutson, 1950).

The Old Plateau is considered to be a pre-Eocene peneplain, which has undergone rejuvenation since the late Tertiary as a result of southeastward tilting of the Westralian Shield. The renewed erosion degraded the existing valleys and sheet-stripped the deep soils, eventually re-exposing the Archaean rocks and forming the New Plateau at a lower level.

The youthful erosion was soon checked by the onset of an increasingly arid climate, which caused the alluviation of trunk valleys as the stream flow fell. Extensive colluvial and alluvial sheets and fans were deposited over the New Plateau surface by the smaller streams.

The Old Plateau is now represented by high-level sandplain and extensive lateritized surfaces eroded in places into undulating hills, and usually ending in south-facing breakaways. The plateau stands between 9 and 30 m above the younger plains, but in areas of Proterozoic sandstone, the most resistant rock to erosional lowering, residual hills stand up to 60 m above the New Plateau.

The drainage pattern of the Old Plateau has two components, both being geologically controlled (Fig. 5). A minor north-south component follows the structural trend of the Proterozoic sediments and results in a dendritic pattern. The major drainage component is southeastward along the regional grain of the Archaean rocks which crop out south and east of Wiluna, and is a trend imposed on the overlying Proterozoic rocks.

GEOLOGY.

The area of investigation is on the Glengarry 1:250,000 geological sheet, which has not yet been entirely mapped. Sofoulis and Mabbutt *in* Mabbutt and others (1963) have outlined the geology from a reconnaissance survey done in 1958. The rock

sequence consists of slightly deformed Proterozoic sediments, Tertiary laterite and duricrust, calcrete valley fills, and Quaternary alluvial/colluvial deposits (Fig. 6).

PROTEROZOIC SUCCESSION

The Proterozoic succession consists of gently folded dolomite, shale, siltstone, sandstone and chert, with some intrusive volcanics, which unconformably overlie Archaean basement rocks. The sediments are correlated by Sofoulis and Mabbutt with part of the Upper Proterozoic Nullagine "system", which was first recognized as a large sedimentary province by Talbot (1926). However recent work by MacLeod (1969) on the Peak Hill 1:250,000 geological sheet, directly to the north of Glengarry, suggests that these rocks probably belong to the Middle Proterozoic Bangemall Group (Daniels, 1966), which occurs extensively in the Pilbara Region to the north.

Near Paroo homestead the Proterozoic sequence is represented by shale, siltstone, dolomite and sandstone, which crop out as hills. These are dissected along north-south-trending fractures and joints into undulating surfaces with south-facing breakaways up to 15 m high. Drainage is southward into the central calcrete. South of the calcreted area, erosional lowering has removed much of the Proterozoic rocks leaving few low, residual hills, and large areas of gibber plain floored with angular chert and shale fragments. Here drainage is poorly defined.

CENOZOIC SUCCESSION

These rocks are thin deposits resulting from the protracted degradation of the Proterozoic sequence.

Tertiary ferruginous laterite and siliceous duricrust cap most of the older surface remnants and form extensive breakaways at the headwaters of tributaries of the trunk drainage system. Sandplain, lake deposits, and red silty sands cemented into a siliceous hardpan, make up more than 50 per cent of the land surface, with alluvial-colluvial and calcrete valley-fill deposits occupying about another 5 per cent. The inter-relationship of these units is illustrated in Figure 7. The hardpan areas and the northern tributary valleys of the Paroo depression often form extensive flood plains during rare periods of high rainfall.

The calcrete occurs as a widespread cover over the floor of the main drainage depression, and is a limestone and opaline silica deposit generally associated with fluvial sediments.

Calcrete

The term calcrete was first suggested in the literature by Lamplugh (1902) to describe some lime-cemented beach detritus occurring in Ireland, but was later used (Lamplugh, 1907, p. 198) to denote some South African superficial, indurated calcium carbonate deposits formed under arid conditions.

The Geological Survey of W. A. uses calcrete to define those "limestone deposits associated with fluvial valley-fill sediments that occur in both broad fossil valleys and in existing trunk drainage systems of the arid interior of the state" (Sofoulis, 1963; Sanders, 1969). The limestones occur mainly at valley floor level characterized by an indurated nodular surface, that may show karstic features such as sink holes, solution pipes, mounds and cavities. Below ground level the deposit may be powdery, granular or massive, and contain unconsolidated detrital bands and cellular opaline silica layers. The sequences in places attain thicknesses up to 30 m but are usually of the order of 5 to 10 m thick. They are partly saturated with groundwater, the water table usually lying at a shallow depth.

Other organisations and investigators (e.g. Sanders, J., and Friedman *in* Chilingar, Bissell and Fairbridge, 1967, p. 175), usually group calcrete with caliche and kankar (kunkur, kunkar). Goudie

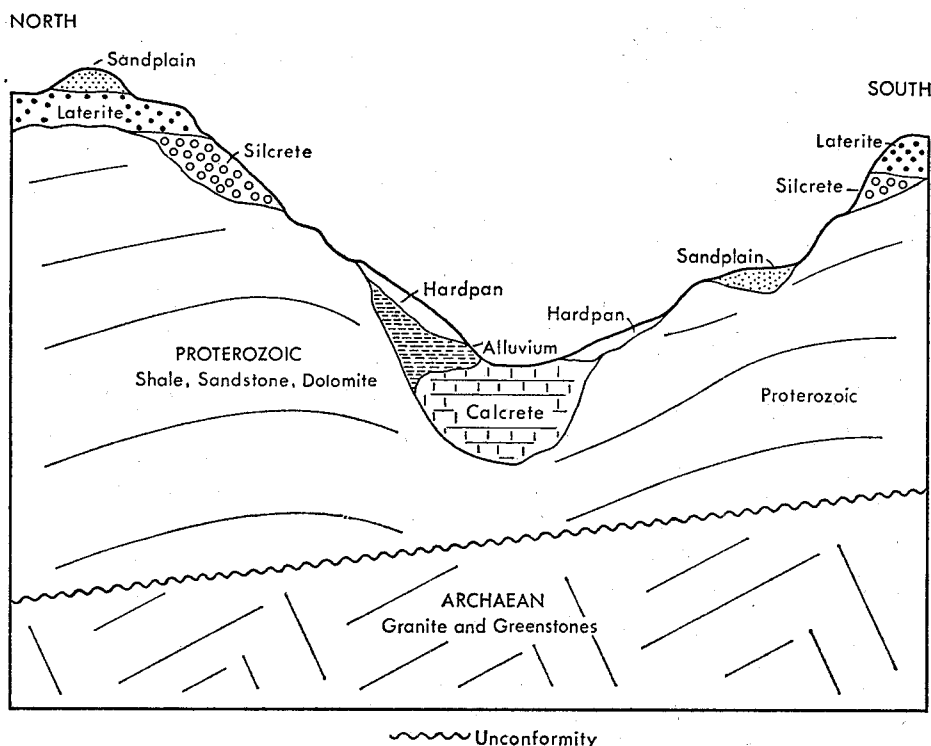

Figure 7. Relationship of rock units north-south through Paroo Sub-basin. Vertical scale greatly exaggerated.

(1972) defines calcretes as "terrestrial materials composed dominantly but not exclusively of calcium carbonate, and involving the cementation of, accumulation in and/or replacement of greater or lesser quantities of soil, rock or weathered material primarily within the vadose zone . . .". This definition fits the rock type recognized by the Geological Survey as kankar. These are superficial, indurated, nodular or sheet calcium carbonate deposits a metre or so thick, developed within the weathered soil profile, commonly over basic rocks, and found throughout the arid interior of Western Australia.

Most valley calcretes above the water table have a kankar-like surface, but their thickness and confinement to drainage lines indicate a genetic and depositional control, at least below the water table, different from that of kankar.

Sofoulis (1963) suggested that calcretes were probably formed as primary chemical precipitates from solution in ground and surface waters, especially in "ponded" sections of the drainage after cessation of a past period of humid climate. Sanders and Harley (1971) consider that carbonate precipitation in blocked sections of drainage lines under arid conditions can explain some small areas of calcrete, but that slow replacement of fluvial silt, sand and gravel by calcium carbonate precipitated from percolating carbonate-saturated ground and soil water is the main mechanism in calcrete formation. Silica taken into solution is often reconstituted into chert (opaline silica) at about the water table. Evidence for the replacement origin is provided by the common occurrence of localized patchy calcrete within extensive fluvial sediments; also, in laboratory examination of bore cuttings, calcite is seen to interfinger and penetrate relict alluvial grains including quartz. Moreover the groundwater in situ pH is high, commonly between 8.0 and 9.5, a condition reported by a number of authors (e.g. Walker, 1962) as being favourable for silica-carbonate inter-reaction.

Recent work on the occurrence of Western Australian calcretes, by Lowry (1971) and Sanders and Harley (1971), indicates that their areal dis-

tribution generally follows the line of outcrop of the Bangemall Group sediments (Fig. 8). The source of lime for the calcretes is thought to come from dolomites of this province; there is evidence for this from the trend of the drainages, and from chemical analyses of both calcrete and its contained groundwater. Generally there is a lack of major calcrete deposits in areas away from the Bangemall Group. Some calcretes do occur in the Archaean province south of Wiluna and in the Officer Basin east of Wiluna, but they are mainly located in ancient drainage valleys demonstrably issuing from the Proterozoic Province (Sanders, 1969; Sanders and Harley, 1971). The Bangemall sediments probably existed at least as far as 180 km south of Wiluna, but have been eroded back to the position they now occupy. Evidence for the southward extent of the Proterozoic rocks is suggested by remnant hills such as Gabanintha, 40 km south-east of Meekatharra, and outliers occurring 60 km south of Lake Carnegie, east of Wiluna. Also, near Ockerburry Hill, 180 km south of Wiluna, buff coloured silstones, known popularly as "Weebo stone" are regarded as Proterozoic.

Calcium carbonate leached from the Archaean ultrabasic rocks has probably helped in the formation of some calcretes, especially where drainage from the Proterozoic sediments does not occur. Such calcretes are usually thin and rarely exceed 10 m in thickness. One important valley-fill calcrete, apparently unrelated to drainage from the Proterozoic succession, occurs near Cue, 260 km southwest of Wiluna. The lime source for this deposit is thought to come from calcium-rich ultrabasic and mafic rocks which surround the calcrete depression.

Chemical analyses of calcretes from Paroo, Wiluna and Cue show them to be high magnesium limestones, averaging nearly 4 per cent magnesium. The Paroo groundwater has a Mg/Ca ratio in excess of 1, when in most groundwaters the ratio is usually about 0.2. The nearest known source of magnesium to the calcrete of Paroo is the Bangemall dolomite. However, groundwaters in calcrete in the Archaean area to the south, for example at Cue, also have Mg/Ca ratios in excess of unity. This magnesium must come from leaching of ultrabasic rocks.

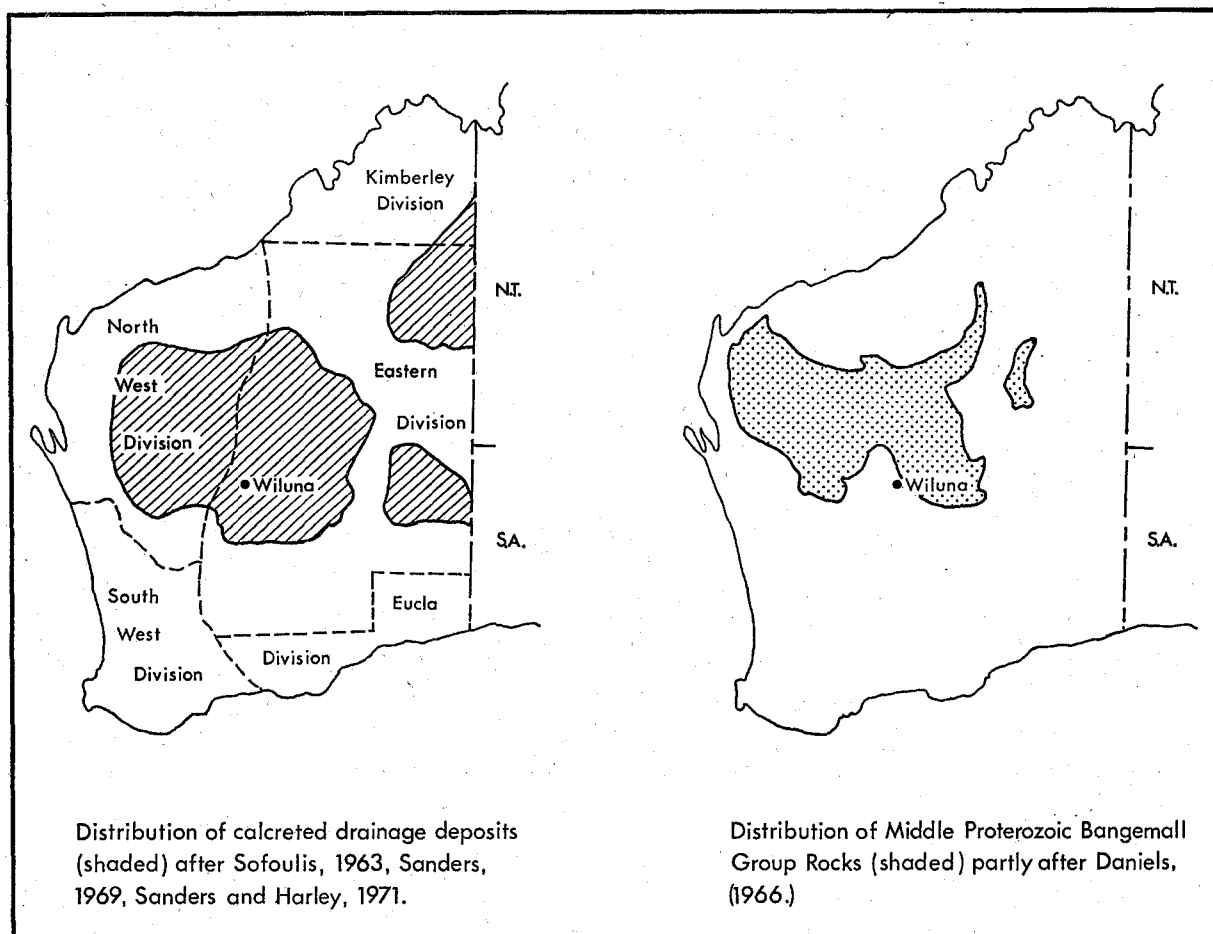

Figure 8. Sketch maps of W.A. showing areal distribution of calcrete and Middle Proterozoic sediments.

Radioactivity in Calcretes

At present calcrete is beginning to assume economic importance as well as being of hydrological significance. The rock appears to absorb and concentrate uranium and thorium, from solution in the percolating groundwater. This was first noticed at Paroo in 1969 after borehole logging with a gamma-ray scintillometer probe. Limestones normally exhibit little gamma-ray activity, but it was noticed that some borehole graphs showed strong anomalous gamma-ray peaks, mainly at about the level of the water table. To test whether traces of radioactive materials were causing the peaks a sample of kankarized surface calcrete and some cuttings of opaline silica from the water table were analyzed for uranium and thorium. A sample of nearby dolomite and some calcrete at Wiluna were analyzed at the same time (Table 2) as a check on the distribution of any radioactivity.

TABLE 2. THORIUM AND URANIUM CONTENT OF SOME CALCRETE AND DOLOMITE SAMPLES

Sample Description	GSWA No.	Parts per million	
		Thorium	Uranium
Calcrete (opaline silica) from Paroo 6, 6 m depth	10897	130	10
Calcrete at surface Paroo 11	10894	70	5
Dolomite at surface 1 km west of Corner Well	10891	60	less than 5
Calcrete from Negrara Creek, Wiluna 1:250,000 Grid ref. 325 702	10896	75	5

Analysis by Government Chemical Laboratories

These analyses indicate greater enrichment of radioactive materials within the calcrete than would normally be expected, particularly the

thorium value. It is assumed that radioactive particles are transported from their provenance by groundwater and where the chemical environment is favourable they are precipitated as complex minerals. Some bore water samples have been submitted to the State X-ray Laboratories for radiometric analysis. Radioactivity within the groundwater was shown to be as much as 70 times greater than the normal background activity of between 10^{-4} and 10^{-3} ppm (Hem, 1970, p. 212). However, the actual elements causing the activity in solution could not be definitely identified.

In 1971 and again in 1972, uranium finds by mining exploration companies were made in calcreted or partly calcreted terrain. These discoveries are in the Archaean province south of Wiluna, and it is suggested that here the uranium was probably leached from granitic rocks of the area and absorbed and enriched within the calcrete. Some radioactive materials obviously occur within the Bangemall sediments as indicated in Table 2, and calcretes nearer these rocks may require closer examination.

Age of Calcrete

The age of most calcretes is not firmly established, although recent mapping and drilling in the East Murchison Goldfields District indicates that calcretization is occurring at present. For example some calcretes within extensive fluvial sediments east of Wiluna (Fig. 5), are patchy both laterally and vertically, and examination of drill cuttings suggests that carbonate replacement is proceeding. However, Mabbutt and others (1963) regard the Wiluna calcretes as being Tertiary and having a possible correlation with the Oakover Formation of the Pilbara Region. On the other hand, MacLeod (1969) assigned an undetermined Quaternary age to calcrete mapped on the Peak Hill Sheet. At Paroo the calcrete development is thick and broad, and is often overlain by alluvial wash and colluvial

detritus. The volume of calcrete at Paroo, estimated from mapping and drilling data is $1.0 \times 10^9 \text{ m}^3$, which is of sufficient bulk to postulate a long period of development. The calcretization process probably immediately followed alluviation of the Lake Way trunk drainage system. For this reason the Paroo Calcrete is mapped as Tertiary in this report, although it is realized that calcrete development has probably continued to the present.

CATCHMENT AREAS

The calcrete at Paroo forms part of the Lake Way drainage basin, which is divisible into three large sub-basins: Paroo Sub-basin, Yandil Sub-basin and Lake Way Sub-basin (Fig. 5).

PAROO SUB-BASIN

The central calcrete depression between bore 18, and the Vermin Proof Fence, has an areal extent of at least 90 km^2 . The sub-basin divide is essentially at right angles (northeast-southwest) to the southeast drainage trend, and is more or less followed by the line of the No. 1 Vermin Proof Fence.

West and north of the main calcrete and tributary to it, are 80 km^2 of strongly cemented alluvium, some minor calcrete and 155 km^2 of interconnected alluvial/colluvial flood plain, respectively. Gradients are low, averaging 0.28×10^{-3} for the calcrete, and 2.0×10^{-3} for the alluvial/colluvial areas. Creek channels are poorly developed and scoured water courses occur mainly in the northern part of the catchment where erosion of the Proterozoic hills is most active.

The calcrete surface has been eroded in places to a metre or so below the surrounding ground level by irregular flood channels floored by calcrete rubble and fine alluvial debris. The channels are often fringed with river gum trees (*Eucalyptus camaldulensis*). The largest of these erosional features is along the northern boundary of the calcrete between bores 6 and 7 (Fig. 6).

Groundwater occurs nearly everywhere in the sub-basin, provided that a bore is drilled deep enough. At its shallowest it is about 4.3 m below ground level in the calcrete. Water quality is best in the alluvial areas where the total dissolved solids range from 450 to 710 parts per million. The groundwater is deepest, 38 m below ground level, in bores constructed south of the Meekatharra-Wiluna Road, and also quality is poor (Fig. 5).

At present groundwater is used for stock and for very limited domestic consumption and irrigation.

YANDIL SUB-BASIN

The Yandil Sub-basin comprises a catchment area of $2,700 \text{ km}^2$ of which 80 km^2 is calcrete occupying parts of the central drainage tract. Alluvial and colluvial deposits make up another 100 km^2 of the catchment area.

Ground surface gradients are mainly low, in the order of 0.57×10^{-3} , but in places scour channels up to 2 m in depth and 19 m wide have developed in the calcrete and alluvium. Where the calcrete is crossed by the Meekatharra-Wiluna Road the scour channel is known as West Creek, but this water-course dissipates southeastwards into a massive calcrete area adjoining Lake Way.

Groundwater is present everywhere in the sub-basin, but is freshest in the northern Proterozoic outcrop areas, where salinity ranges from 430 to 2,000 ppm TDS. The groundwater is at shallowest depth, about 4.3 m below ground level in the calcrete, but is brackish, with salinities ranging from 1,750 ppm TDS at Yandil Woolshed well to 5,500 ppm TDS in a well near Lake Way.

LAKE WAY SUB-BASIN

The area immediately west of Lake Way forms this sub-basin. The catchment area is poorly defined, with most drainage starting at a line of east-west hills which form the sub-basin northern water divide. Rocks of the catchment area are altered Archaean volcanics, which hold potable groundwater at depths of between 9 and 20 m below ground level.

HYDROGEOLOGY OF CALCRETE AT PAROO

The outcrop area of highly cavernous and permeable calcrete is broadest northwest of Paroo Woolshed and narrowest where crossed by the Vermin Proof Fence. The drilling showed that the calcrete occupies a shallow trough overlying Proterozoic shale and siltstone, and which bounds it on the southern side. Alluvium occurs on the northern flank (Figs. 6 and 9).

Bores 2 to 18 were constructed using a Mines Department rotary air-drill, the bore diameter was generally 178 mm, and depths ranged from 12 to 37.5 m. Each hole was completed in shale. This method of drilling did not permit the recognition of true lithologies and section thicknesses, because the drill penetrated the formations very rapidly and tended to pulverize the aquifer material. These shortcomings were mainly overcome by logging the holes with a gamma-ray probe, and later re-drilling some of the sites with a percussion rig which permitted the recovery of relatively true rock samples.

Bores 19 to 24 were drilled to 178 mm diameter by percussion rig and depths ranged from 12 to 18.3 m. Bore data are summarized in Table 3.

The upper surface of the calcrete is rubbly and sometimes karstic, but is otherwise a plane surface declining gently southeastward from its high point at bore 18. The surface is permeable because of sink holes and caverns in zones of indurated limestone, and because the calcareous soil developed on the limestone is very porous. Developments of gilgai (crabhole) terrain in the soil also facilitate the access of surface water into the calcrete.

TABLE 3. PAROO DRILLING DATA

Bore No.	Total Depth	Estimated thickness of calcrete*	Estimated thickness of permeable, saturated calcrete*
	m	m	m
2	15.8	12	4
3	36.6	3	3
5	22.3	7.6	3.6
6	30.5	11.6	4.6
7	17.0	10.7	4.9
8	15.0	9.1	5.5
9	37.5	3	0
10	22.6	0	0
11	12.0	0	0
12	30.5	9.1	3.3
13	30.5	10.4	4
14	21.3	10.7	4.6
15	27.4	11	4.6
16	15.0	7.3	3.3
17	18.3	9.1	4.6
18	14.3	11	6.1
19	12.0	0	0
20	15.0	11	1.5
21	12.0	0	0
22	18.3	9.1	0
23	18.3	3	0
24	12.0	0	0

* From lithology and gamma-ray logs.

The subsurface lithology of the calcrete is variable, being made up of hard limestone near the surface, opaline silica at about the water table, and friable calcareous material, with odd bands of detrital clay, silt and sand below the silica zone. The bands of opaline silica are massive and up to 1 m thick, but have fissures and cavities in places where fracturing has occurred. Caverns and inter-connecting conduits have also developed in the calcareous material below the silica zone as a result of groundwater circulation. Some caverns communicate by fissures with the surface sinkholes.

Towards its base the calcrete becomes silty and much less permeable. The limestone material normally permits boreholes to stand up uncased.

The calcrete thickness is fairly uniform at between 7.6 and 11.6 m and the average saturated thickness is 4.46 m (Fig. 9).

GROUNDWATER RESOURCES

The groundwater resources of the calcrete are evaluated from bore pumping test data. The results of tests performed on nine bores, in 1969, using a low capacity centrifugal pump, have been reported previously (Sanders, 1971).

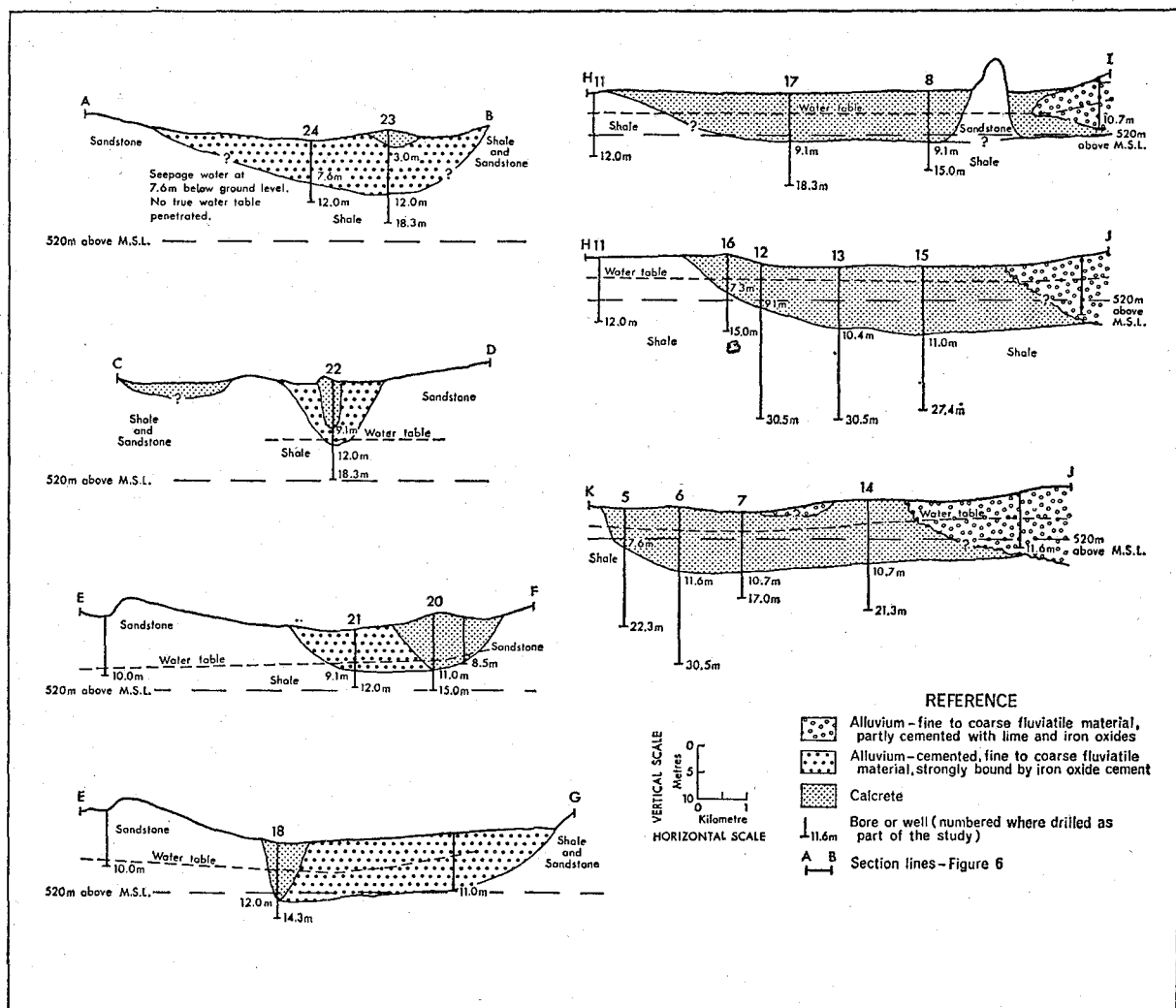

Figure 9. Paroo Station project, Wiluna. Diagrammatic cross sections, Paroo calcrete aquifer.

In late 1971, three bores, 6, 15 and 17, were re-tested using a turbine pump capable of yielding up to $3.3 \times 10^3 \text{ m}^3$ of water per day. The bores were selected because they penetrated calcrete which apparently exhibits differing aquifer characteristics, owing to localized aquifer inhomogeneities. Bore 6 is sited in permeable, relatively homogeneous calcrete near the outlet of the Paroo Sub-basin; bore 15 is located in cavernous calcrete, where the borehole and associated observation wells intersect small cavities and conduits; bore 17 is sited in massive limestone, penetrating about 7.6 m of cemented calcrete, and 1.5 m of loosely bound fluvialite sand and gravel. A band of opaline silica occurs just below the water table in the pumped bore at site 17, but not in the observation wells. Relevant test data are listed in Table 4.

TABLE 4. PAROO SUB-BASIN CALCRETE PUMPING TEST RESULTS

Bore No.	Duration time days	Yield m^3 per day	Maximum drawdown in observation well, metres		Salinity pumped water ppm TDS (conductivity)
			r = 7.6 m A	r = 15.2 m B	
6	16.0	3.06×10^3	0.415	0.357	1,010
15	5.05	3.29×10^3 *	0.019	0.019	780
17	3.9	1.20×10^3	0.104	0.1006	710
	8.0	0.875×10^3	0.083	0.079	710

* Indicates pump capacity rather than potential bore yield at time of pumping test.

Formation Parameters

The formation parameters, transmissivity, specific yield and aquifer anisotropy were calculated from analyses of the various observation well time-drawdown data using standard type curve matching procedures, and from other graphical methods.

For bore 6 the time-drawdown data were analysed using a procedure established by Boulton (1963), which permits the effects of delayed yield from aquifer storage to be taken into account in calculating the aquifer parameters. A method devised by Stallman (1965) which allows for the effects of aquifer anisotropy to be recognized, was also used. These methods gave comparable results for the data from observation well B, but the time-drawdown data from observation well A could not be fitted to the Stallman curves (Table 5). An analysis was also done by the Thiem (1906) method, which is a basic mathematical solution for steady radial groundwater flow, and this gave similar values for transmissivity and specific yield. The mean rounded value for transmissivity at the test site by the three methods is $5,700 \text{ m}^2/\text{d}/\text{m}$ and the average value for specific yield is 0.26.

Bore 15 was a high capacity bore with little drawdown being recorded in either the pumped bore or the associated observation wells. The time-drawdown data for this test could not be satisfactorily analysed as the data curves were strongly distorted, due to the effects of preferential groundwater flow through interconnecting conduits leading toward the pumping bore. An order of transmissivity between 15,000 and 20,000 $\text{m}^2/\text{d}/\text{m}$ was indicated however, but the calculated specific yields are all invalid. A Thiem distance-drawdown analysis could not be done because the slope

of the semi-logarithmic plot was too flat to be realistically appraised. Residual drawdown analysis of the observation well recovery data does however, give comparable results for transmissivity, and the rounded average for the test site by this method is 18,800 m²/d/m.

TABLE 5. PAROO SUB-BASIN

CALCRETE Aquifer Parameters (derived by various analytical techniques from pumping test data from Bores 6, 15 and 17†)						
Bore No.	6		15		17	
Observation Well	A	B	A	B	A	B
Method of aquifer analysis parameter*						
Boulton T	5,690	5,690
Sy	0.29	2.27
Stallman T	5,720	5,620	5,300
Sy	0.26	0.27	0.21
Thiem T	5,650					
S	0.22					
Residual drawdown T (from recovery data)	17,800	19,700	6,280	6,280

* Transmissivity (T) m²/d/m = m²/d Sy = specific yield.

† Pumping tests were carried out using British units of measure, and the analyses were done using these units, but have been metricated to meet the requirements of this report. Graphical plots of the tests are held in the library of the Geological Survey of Western Australia.

The calculated specific yields for Bore 15, by being invalid suggest that the aquifer conditions at the test site are not ideal, and are not adequately represented by the various mathematical assumptions used in normal aquifer analysis. The calcrete at the test site was cavernous and fissured, and of high secondary porosity.

Similar analytical problems were encountered with the time-drawdown data from the two pumping tests at site 17. Strongly distorted, observation well plots resulted from the 3.9 day test at 1.20 x 10³ m³/d of water. The second test of 8 days duration pumped at 0.875 x 10³ m³/d gave observation well time-drawdown curves which could be matched to a Stallman type curve for a partially penetrating pump bore and observation well, influenced by aquifer anisotropy. No other type curve solution would fit the data. All the bores at site 17 had been constructed and screened to fully penetrate the aquifer, but where an aquifer has intercalated layers of differing hydraulic conductivity, these may cause a marked change in the shape of the pumping response curve and this appears to be the case at site 17.

The cemented calcrete and bands of opaline silica at about 7.6 m level in the pumped bore may have induced the partial penetration effect. The low vertical hydraulic conductivity compared to the radial value (Table 5) indicates that the aquifer is strongly anisotropic.

Residual drawdown analysis of recovery data from observation wells gave transmissivities somewhat higher than those derived by the Stallman method. The mean value of 5,900 m²/d/m is accepted here as it compares favourably with the transmissivity at site 6.

The average specific yield value of 0.24 at site 17 as calculated by the Stallman method is accepted, as no other values were found to be valid or convincing.

The results of the pumping tests showed variable aquifer conditions through the calcrete, suggesting the need for an average to be struck for the formation parameters before they could be applied to calculating groundwater storage and discharge. Some parts of the calcrete were shown to be exceptionally permeable and porous (e.g. site 15), while other parts were indicated during drilling to be silty and of low permeability and low transmissivity (e.g. bores 12 and 13, Sanders, 1971, Plate 4). Geological mapping of the calcrete indicates that these areas are of generally equal extent and therefore averaging the aquifer parameters should be reasonable.

A transmissivity of 5,800 m²/d/m, averaged from the tests on bores 6 and 17, and a specific yield 0.26 have been adopted for the whole calcrete aquifer. A transmissivity value of 6,320 m²/d/m and specific yield of 0.3 were adopted in the 1971 report.

Pumping tests at low rates were conducted on three bores (19, 20 and 22), northwest of the explored calcrete, to determine aquifer conditions. Bore cuttings and preliminary water tests during drilling had already indicated that permeabilities in this area were low. The alluvial and colluvial material is strongly bound by lime and iron oxide cements, and the calcrete where it occurs is mainly recemented with carbonate. The calculated transmissivities are low (Table 6), and specific yields could not be determined from the tests. The test on bore 22 was unreliable.

TABLE 6. AQUIFER PARAMETERS BORE 19 AND 20

Bore No.	Duration Time days	Yield metres ³ per day	Transmissivity metres ² per day per metre
19	0.3	17.45	0.816
20	2.0	338.1	1,230

These results indicate that the groundwater in this area moves very slowly and is of little recharge value to the calcrete farther down valley, and of no supply potential.

Discharge—Recharge regime

The discharge-recharge regime is governed by groundwater movement as indicated by the potentiometric surface and salinity pattern, and by rainfall over the catchment area. The potentiometric surface of the aquifer was found from survey leveling, and is represented on Figure 6 as hydraulic contours. The direction of groundwater movement is normal to the hydraulic contours and is toward the southeast. The gradient on the water surface is fairly constant at 0.12 x 10⁻³ over the broader part of the calcrete increasing to 0.57 x 10⁻³ near the discharge section at the Vermin Proof Fence.

Discharge

The groundwater in the calcrete is in dynamic equilibrium with the physical environment, it moves slowly through the aquifer down-gradient to be ultimately evaporated from the terminal salt lake, and it is replenished by rainfall over the catchment area infiltrating to the water table. Other forms of discharge are operating, mainly evapotranspiration and discharge into the poorly permeable rocks surrounding the aquifer. Evapotranspiration is probably considerable but its effects have not been directly measured as a detailed vegetation and land-use survey would be required. Also, as vegetation is relatively sparse over calcrete, and the water table is deeper than 4 m, except where the calcrete is deeply channelled, evapotranspiration would be minor compared with natural underflow and discharge down-gradient.

Subsurface discharge from the calcrete is calculated from transmissivity values found for bores on a cross section at right angles to the direction of groundwater flow.

The computation for underflow follows Darcy's Law (1856) which states that laminar (viscous) flow of water through sand is proportional to the hydraulic gradient, and may be expressed as:

$$Q/A = -K \, dh/dl.$$

where Q = discharge.

A = cross-sectional area.

K = hydraulic conductivity.

dh/dl = hydraulic gradient (G).

For groundwater aquifers the law may be expressed in the simplified form: Q = T (transmissivity) x W (width of section) x G.

The underflow discharge from the calcrete is regarded as an ideal optimum yield for the aquifer, as abstraction of groundwater at a rate equivalent to underflow will subsequently overwhelm discharge past the point of withdrawal, thus utilizing water which is otherwise lost, and should not in the long term reduce the volume of water held in aquifer storage. However during the process of pumpage depletion of part of the groundwater storage will occur before a new equilibrium or water balance can be established, and this may take considerable time.

Two discharge sections have been selected for the calculation of underflow through the aquifer. Section 1 is through bores 17 and 8, and is 6,000 m in length. The hydraulic gradient across the section is 0.12×10^{-3} . Section 2 is near the calcrete outlet, and passes through bore 6. The length of this section is 3,000 m and the gradient 0.57×10^{-3} . Transmissivity for the sections has been adopted at $5,800 \text{ m}^3/\text{d}/\text{m}$.

Q underflow	=	T x W x G m^3/d
Section 1	=	$5,800 \times 6,000 \times 0.00012$
Underflow	=	$4,180 \text{ m}^3/\text{d}$
Section 2	=	$5,800 \times 3,000 \times 0.00057$
Underflow	=	$9,920 \text{ m}^3/\text{d}$

The difference of $5,740 \text{ m}^3/\text{d}$ between the two discharge values is considered to be the volume of recharge to the area between the two cross-sections, and this must come mainly from rainfall onto the calcrete and surface runoff from the immediate alluvial catchment areas to the north (Figs. 5 and 6).

In arid zone groundwater basins the volume of discharge past the outlet of the basin may be regarded in the long term as about equal to the long term recharge to the system. Hence a mean discharge for the Paroo calcrete of $9,920 \text{ m}^3/\text{d}$, equivalent to $3.62 \times 10^6 \text{ m}^3/\text{year}$ would, over a number of years, essentially equal recharge. The gradient on the water table used for the calculation was a minimal value, arrived at after mapping the hydraulic surface at a time of severe drought when groundwater levels were lowest, and consequently the underflow discharge may be conservative.

The water level in the Paroo bores has been monitored since June, 1969, and over the 2-year period June, 1969 to late May, 1971 the water level in bores has fallen an average of 0.384 m. There has been severe drought in the Wiluna district since mid-1968, with the total rainfall at Wiluna over the period June, 1969 to June, 1971 being 212 mm; the average rainfall for the past 10 years for a similar June to June 2-year period is approximately 498 mm. Such precipitation as has occurred during the drought has usually been from intermittent storms of mainly low intensity, lasting less than 24 hours resulting in little recharge to the aquifer. Average rainfall at Yandil Station near Paroo is reported by Chapman (1962) as being somewhat less than at Wiluna. Under these conditions it is reasonable to expect a steady decline in the groundwater level.

The water table depression over the 90 km^2 of calcrete, represents loss from storage for the 2-year period, taking the aquifer specific yield as 0.26, of:

$$90 (1,000)^2 \times 0.384 \times 0.26 \text{ m}^3 = 8.99 \times 10^6 \text{ m}^3 \text{ (rounded)}$$

If it is assumed that no effective recharge to the calcrete system has taken place over the 2-year period then the volume of water lost would be mainly due to outflow down-gradient evapotranspiration and lateral discharge into the basement rocks about the calcrete. Normal outflow from the calcrete for the 2-year period would be about $7.24 \times 10^6 \text{ m}^3$ ($2 \times 3.62 \times 10^6 \text{ m}^3/\text{year}$), which leaves a loss of $1.75 \times 10^6 \text{ m}^3$ ($8.99 \times 10^6 - 7.24 \times 10^6 \text{ m}^3$), which may be attributed to evapotranspiration and discharge into confining rocks at the margins of the calcrete. On an annual basis these losses represent $0.87 \times 10^6 \text{ m}^3$ of water which may be added to the normal yearly discharge of $3.62 \times 10^6 \text{ m}^3$ to give an estimated total discharge or water loss from the calcrete of $4.49 \times 10^6 \text{ m}^3/\text{year}$.

This latter maximized loss from the calcrete should also be the equivalent to the long-term recharge, indicating that a potential pumpage of this order should not greatly affect groundwater held in aquifer storage.

Recharge

Groundwater replenishment in the Wiluna district occurs entirely from rainfall and mainly during major storms. The frequency of occurrence of such storms is of importance in understanding the water balance of the district. Chapman (1962, p. 6-9) analysed various frequencies of storm events for the Wiluna area, and these have been summarized and discussed in the interim report on the Paroo calcrete (Sanders, 1971).

The mean annual rainfall at Paroo is about 200 mm, with a storm rainfall of 76 mm having the probability of occurrence of once in 2 years, or 119 mm occurring once in 5 years. The quantity of rainfall required to cause runoff depends on the dryness of the catchment and on the intensity of the rainfall. Local people consider that at least 50 mm are required before creeks in the Paroo area flow, although much of the runoff is by sheet flooding. Infiltration is very rapid into the calcrete but is considerably slower into the hard pan covering the alluvial sediments. Most recharge occurs after runoff from the catchment areas which inundates the calcrete.

In mid-June, 1971 an unusual 8-day storm depression brought 75 mm of rain to Wiluna, and about the same amount of precipitation to the surrounding district. By September, 1971 the water level in the Paroo bores had completely recovered and in some bores the water had risen above the maximum of the preceding 2 years. The June, 1971 storm rain of about 75 mm over the catchment area of $2,300 \text{ km}^2$ was sufficient to replace the $8.99 \times 10^6 \text{ m}^3$ of groundwater depleted during the drought. This represents recharge to the calcrete of 5.2 per cent of the rainfall over the whole catchment. The calculation ignores infiltration into the rest of the catchment and only takes account of water which recharged the calcrete up to September, 1971. As refilling probably continued for a considerable time after this date the percentage value for the storm is probably of the right order but is not conclusive.

Expressed in another way the natural annual groundwater loss from the calcrete of $4.49 \times 10^6 \text{ m}^3/\text{year}$, represents a recharge coefficient of 0.98 per cent of an adopted annual catchment rainfall of 200 mm over the total $2,300 \text{ km}^2$ catchment. These percentage differences indicate that most recharge follows the higher storm rainfalls.

Runoff past the outlet of the Paroo Sub-basin only occurs after precipitation equivalent to the once in 5 years storm event of about 119 mm. This can result in flow along the deep erosion channel in calcrete on Yandil Station, and eventually, when added to the runoff from the Yandil catchment area, may cause flow along West Creek (Fig. 5).

Salinity Pattern

Isohaline plots of the calcrete have been made and discussed previously (Sanders, 1971, Plate 5). They show that groundwater salinity increases gradually from north to south across the aquifer; the least saline water being in the tributary alluvial areas, as indicated by bore and well salinities shown on Figure 5. The plots indicate recharge from the northern alluvial zones. A broad area of fair quality water about bore 17 indicates direct infiltration of rainfall, and intake of water dumped on the cavernous part of the calcrete after runoff from the catchment.

Stored Water

The volume of stored water in the calcrete may be calculated by applying the accepted aquifer specific yield of 0.26 over 90 km^2 of aquifer having an average saturated thickness of 4.46 m.

$$\begin{aligned} \text{Volume} &= \text{Area} \times \text{aquifer thickness} \times \text{specific yield} \\ &= 90 (1,000)^2 \times 4.46 \times 0.26 \text{ m}^3 \\ \text{Volume (rounded)} &= 104.4 \times 10^6 \text{ m}^3 \end{aligned}$$

This is sufficient stored water to permit pumpage well in excess of normal discharge, if this is considered desirable, and to permit continued abstraction over long periods of drought. Mining of the groundwater at a rate greater than it may be replaced during infrequent flood events is not advisable as a conserved perpetuating resource would be the most sensible management.

Hydrochemistry

Recharge to the calcrete is entirely from rainfall. Dissolved solids in the groundwater are derived from the rain, the aquifer and its catchment, and cotamination from the surface.

Standard chemical analyses of Paroo groundwater were carried out by the Government Chemical Laboratories and are reported elsewhere. Over the calcrete the total salinities range from 710 ppm to 1,330 ppm TDS, but the salinity profile in each borehole varied little for the full thickness of the aquifer. The total salt content is within the upper limit of potability of 1,500 ppm as set for Western Australia by the Public Works Department. Also the concentration of most individual ions is within accepted limits, except for the nitrate and fluoride ion concentrations.

The nitrate concentration in the groundwater is high, ranging from 34 ppm to 124 ppm, but this is characteristic of most Wiluna district groundwaters (Morgan, 1966). Ingestion of water containing nitrates in excess of 50 ppm is reliably reported as causing infantile methaemoglobinaemia, an illness confined to infants during their first months of life. In Western Australia no incidence of the disease has yet been recorded although groundwater containing high nitrates has been used for domestic consumption since the beginning of the century. In the environment of central Western Australia domestic use of the Paroo groundwater should be satisfactory, but careful watch must be kept for any incidence of anoxia.

The fluoride concentration (0.8 ppm to 2.0 ppm) in Paroo groundwater is higher than recommended for an area where the mean maximum temperature is 29°C. The optimum level of fluoride in drinking water at this temperature is 0.7 ppm (United States Department Public Health, 1962).

The water is also very hard, and although this may not be deleterious to health it does affect pipe lines, boilers, and domestic utensils. The groundwater hardness at Paroo ranges from 330 ppm to 445 ppm CaCO₃. Bean (1962) recommends that an ideal quality water should not contain more than 80 ppm CaCO₃.

Some groundwater samples were submitted to the State X-ray Laboratories for analysis of radiation in solution. Some degree of radioactivity, up to 70 times background was recorded, but it is not considered to be a health hazard.

HYDROLOGY OF YANDIL SUB-BASIN

Geological mapping of aquifer rocks, and well and bore census work has been done in this sub-basin, but no exploratory drilling. Groundwater is brackish but of good stock quality, and is satisfactory for many industrial uses. Some water was pumped from three wells in calcrete near Lake Way between 1933 and 1946 for use in a gold beneficiation process at the now abandoned Wiluna gold mines (Fig. 5). The volume of water abstracted was never recorded, but the type of pump used at each well was probably capable of pumping 280 m³/d of water. The wells are no deeper than 9 m, and do not fully penetrate the aquifer. The water level in the wells now stands at 3.9 m below ground level.

GROUNDWATER RESOURCES

Most groundwater is available from the three calcreted areas within the central drainage depression. The largest of these calcretes adjoins Lake Way and has an areal extent of 35 km². The true thickness of the rock is not known, but from census information and from some recent diamond drill-holes put down for nickel search, a thickness of at least 15 m is indicated. The calcrete overlies Archaean ultramafic rocks which are of interest

as possible host rocks to nickel mineralization, and consequently much of the calcrete is pegged for mineral claims.

The near-surface groundwater ranges in salinity from 4,400 ppm to 5,500 ppm TDS, but the water at depth in the aquifer is probably more saline, particularly near Lake Way. Examination of the Mine wells shows that the calcrete is massive with recent carbonate growth sealing many of the older waterworn flow channels. Much of the primary porosity has been lost and even some of the secondary porosity greatly reduced. This has caused a considerable loss in permeability and reduction in aquifer specific yield. The same effects have been noted by the author in the Lake Violet Basin calcrete southeast of Wiluna, where recent tests indicate a transmissivity of 660 m²/d/m and specific yield of 0.05.

If the Lake Way calcrete has a specific yield of about 0.05 and has an assumed average saturated thickness of 10 m then there would be: $10 \times 0.05 \times 35 (1,000)^2 = 17.5 \times 10^6$ m³ of water held in aquifer storage. These conclusions are subjective and it is recommended that the hydrology of the Yandil Sub-basin be the subject of a comprehensive programme of investigation in order to place discharge, evapotranspiration and storage estimates on a firm basis prior to instituting any scheme for groundwater abstraction.

The smallest area of calcrete in the Yandil Sub-basin is near Bubble Well and has an indicated extent of 15 km². The calcrete is vegetated along the channel of West Creek by large stands of river gum trees. The watercourse is up to 2 m deep and 19 m wide but flow is intermittent and probably only occurs as a result of very heavy rainstorms permitting the overtopping of the calcrete aquifers farther upstream.

The area is a local scenic spot and picnic ground and its conservation is recommended.

The calcrete aquifer on Yandil Station immediately southeast of Paroo, has an area of 30 km², the contained groundwater ranging in salinity from 1,540 to 4,550 ppm TDS, and is generally at a depth of 4 m below ground level. Much of the water is derived as underflow from the Paroo calcrete.

The volume of water held in storage in this aquifer is estimated by assuming the specific yield to be 0.26 and the average saturated thickness 5 m, as indicated from the well census; storage is then: $30 (1,000)^2 \times 0.26 \times 5 = 39 \times 10^6$ m³, part of which could be abstracted for industrial use.

An approximate estimate of the groundwater discharge from the Yandil Sub-basin can be derived by assuming a transmissivity of 660 m²/d/m and applying it to a 6,000 m cross section near Garden Well where the hydraulic gradient is 1.9×10^{-3} . The estimated underflow towards Lake Way is then 2.7×10^6 m³/year. However, 3.62×10^6 m³/year is supplied to the Yandil Sub-basin groundwater storage as underflow from the Paroo calcrete, and probably another 5.8×10^6 m³/year is added through infiltration of rainfall over the Yandil catchment reaching the water table. This latter value is derived by taking the Paroo discharge as equivalent to 0.98 per cent of the mean annual rainfall over the full Paroo catchment area, and applying that percentage as a recharge coefficient for the Yandil catchment. The total annual groundwater inflow to the Yandil system is then of the order of 9.4×10^6 m³, but outflow is only 2.7×10^6 m³/year. Clearly a substantial volume of water appears to be lost from the system and this is attributed to evapotranspiration.

Much of the 260 km² calcrete and alluvial terrain in the Yandil Sub-basin is vegetated by river eucalypts which have their roots in water. Forestry officers report that these trees transpire very large volumes of water annually, and could easily account for annual groundwater losses of about 6.7×10^6 m³.

CONCLUSIONS

Analysis of drilling and pump testing data from the 90 km² calcrete aquifer on Paroo Station has indicated that up to 3.62×10^6 m³/year of potable

water is discharged past the outlet of the sub-basin. Indirect measurements of evapotranspiration and groundwater discharge into the confining rocks of the calcrete indicate an annual water loss from the aquifer by these means of $0.87 \times 10^6 \text{ m}^3$. The total discharge or aquifer loss is then $4.49 \times 10^6 \text{ m}^3/\text{year}$, which represents 0.98 per cent of the mean annual rainfall of 200 mm falling over the total catchment area of $2,300 \text{ km}^2$.

There are $104.4 \times 10^6 \text{ m}^3$ of groundwater held in aquifer storage.

Southeast of the Paroo calcrete are three smaller calcretes all located in the Yandil Sub-basin. Underflow through each of these has not been estimated, but $39 \times 10^6 \text{ m}^3$ of brackish water should be stored in the calcrete joining the Paroo system, and $17.2 \times 10^6 \text{ m}^3$ of poorer quality water stored in the adjacent calcrete to Lake Way. Storage within the smallest calcrete has not been estimated, as it is considered to be an area worthy of groundwater conservation. Annual rainfall recharge to the Yandil Sub-basin could be at least $5.8 \times 10^6 \text{ m}^3$. Discharge into Lake Way is possibly only about $2.7 \times 10^6 \text{ m}^3/\text{year}$ which indicates that substantial groundwater reserves are lost from the system annually. These losses are attributed to evapotranspiration.

Uranium and thorium enrichment has been noted in the Wiluna district and other calcretes, and exploration for these elements is encouraged, although government agencies should be aware of the possible clash of interests between mineral mining and groundwater exploitation.

REFERENCES

- Bean, E. H., 1962, Progress report on water quality criteria: *Am. Water Works Assoc. Jour.*, v. 54, p. 1,313-1,331.
- Boulton, N. S., 1963, Analysis of data from non-equilibrium pumping tests allowing for delayed yield from storage: *Inst. Civil Engineers Proc.*, v. 26, p. 469-482.
- Chapman, T. G., 1962, Hydrology survey at Lorna Glen and Wiluna, W.A.: *Australia CSIRO Land Res. and Reg. Surv.*, Tech Paper No. 18.
- Chilingar, G. V., Bissell, H. J., and Fairbridge, R. W., (Eds.), 1967, *Carbonate rocks, origin, occurrence and classification*: Amsterdam, Elsevier.
- Daniels, J. L., 1966, Revised stratigraphy, palaeo-current system and palaeogeography of the Proterozoic Bangemall Group: *West. Australia Geol. Survey Ann. Rept.* 1965, p. 48-56.
- Darcy, H., 1856, *Les fontaines publiques de la ville de Dijon*: Paris, V. Dalmont.
- Ellis, H. A., 1953, Report on underground water supplies in the area east of Wiluna, W.A.: *West. Australia Geol. Survey Ann. Rept.* 1951, p. 44-47.
- Goudie, A., 1972, The chemistry of world calcrete deposits: *Jour. Geology* v. 80, p. 449-463.
- Hem, J. D., 1970, Study and interpretation of the chemical characteristics of natural water: *U.S. Geol. Survey Water Supply Paper* 1473, (2nd ed.).
- Jutson, J. T., 1950, *The Physiography (geomorphology) of Western Australia*: West. Australia Geol. Survey Bull. 95 (3rd ed.), 366 pp.
- Lamplugh, G. W., 1902, Calcrete: *Geol. Mag.* v. 9, p. 575.
- 1907, Geology of the Zambesi Basin around Batoka Gorge: *Geol. Soc. London Quart. Jour.*, v. 63, p. 162-216.
- Lowry, D. C., 1971, Geological reconnaissance of the Officer Basin, 1970: *West. Australia Geol. Survey Rec.* 1971/6 (unpublished).
- Mabbutt, J. A., Litchfield, W. H., Speck, N. H., Sofoulis, J., Wilcox, D. G., Arnold, J. M., Brookfield, M., and Wright, R. L., 1963, General report on lands of the Wiluna-Meekatharra area, Western Australia, 1958: *Australia CSIRO Land Res. Series* No. 7.
- MacLeod, W. N., 1969, Explanatory Notes on the Peak Hill 1:250,000 Geological Sheet, W.A.: *West. Australia Geol. Survey Rec.* 1969/17 (unpublished).
- Morgan, K. H. 1966, Hydrogeology of the East Murchison and North Coolgardie Goldfields: *West. Australia Geol. Survey Ann. Rept.* 1965, p. 14-19.
- Sanders, C. C., 1969, Hydrogeological reconnaissance of calcrete areas in the East Murchison and Mt. Margaret Goldfields: *West. Australia Geol. Survey Ann. Rept.* 1968, p. 14-17.
- 1971, Paroo calcrete hydrogeological investigation interim report: *West. Australia Geol. Survey Rec.* 1971/2 (unpublished).
- Sanders, C. C., and Harley, A. S., 1971, Hydrogeological reconnaissance of parts of Nabberu and East Murchison Mining Fields, 1970: *West. Australia Geol. Survey Ann. Rept.* 1970, p. 23-27.
- Sofoulis, J., 1963, The occurrence and hydrological significance of calcrete deposits in Western Australia: *West. Australia Geol. Survey Ann. Rept.* 1962, p. 38-42.
- Stallman, R. W., 1965, Effects of water-table conditions on water-level changes near pumping wells: *Water Resources Research*, v. 1, No. 2, p. 295-312.
- Talbot, H. W. B., 1926, A geological reconnaissance of part of the Ashburton drainage basin: *West. Australia Geol. Survey Bull.* 85, 113 pp.
- Thiem, G., 1906, *Hydrologische methoden*: Leipzig, J. M. Gebhart.
- United States Department of Health, Education and Welfare, 1962, *Drinking Water Standards*: Washington, D.C., U.S. Govt. Printer.
- Walker, T. R., 1962, Reversible nature of chert-carbonate replacement in sedimentary rocks: *Geol. Soc. America Bull.* v. 73, p. 237-242.

STRATIGRAPHIC NOMENCLATURE OF CRETACEOUS ROCKS IN THE PERTH BASIN

by A. E. Cockbain and P. E. Playford

ABSTRACT

An intra-Neocomian unconformity separates the Middle Jurassic to early Neocomian Yarragadee Formation from the overlying Cretaceous rocks, most of which are placed in the Warnbro and Coolyena Groups. The Early Cretaceous Warnbro Group consists of the South Perth Shale (with basal Gage Sandstone Member), Leederville Formation and Dandaragan Sandstone, and is a mixed marine and continental clastic sequence. The disconformably overlying Coolyena Group comprises (in ascending order) the Osborne Formation, Molecap Greensand, Gingin Chalk and Poison Hill Greensand and is a marine glauconite-bearing se-

quence of Albian to Late Cretaceous age. The Bullsbrook Beds, Donnybrook Sandstone and Maxicar Beds are probably correlatives of the Warnbro Group and the Lancelin Beds correlate with the upper part of the group. The Bunbury Basalt is a flow deposited on the unconformity surface of the Yarragadee Formation.

INTRODUCTION

Regional mapping by the Geological Survey and exploration for hydrocarbons by West Australian Petroleum Pty. Ltd. (Wapet) have resulted in a better understanding of the Cretaceous rocks in

the Perth Basin. This, in turn, has necessitated a revision of the stratigraphic nomenclature, and the purpose of this paper is to formalize this revision and concisely describe the units.

The revised stratigraphic nomenclature may be summarized as follows (Fig. 10):

Main sequence		Probable equivalents
Coolyena Group (Albian-Senonian)	Poison Hill Greensand	Lancelin Beds
	Gingin Chalk	
	Molecap Greensand	
	Osborne Formation	
DISCONFORMITY		
Warnbro Group (Neocomian-Aptian)	Dandaragan Sandstone	Bullsbrook Beds Donnybrook Sandstone and Maxicar Beds
	Leederville Formation	
	South Perth Shale	
UNCONFORMITY		
(Middle Jurassic-Neocomian)	Yarragadee Formation	

Cretaceous sediments are exposed at the surface over a wide area of the Perth Basin, although outcrops are generally poor. An important unconformity occurs in the Neocomian sequence; Lower Neocomian, Upper and Middle Jurassic rocks below the unconformity are placed in the Yarragadee Formation whilst most of the Cretaceous sequence above the unconformity is placed in the Warnbro and Coolyena Groups. The Cretaceous part of the Yarragadee Formation has a maximum known thickness of 1,500 m and the overlying Cretaceous rocks exceed 1,600 m in thickness.

YARRAGADEE FORMATION

The Yarragadee Formation ("Yarragadee Beds" of Fairbridge, 1953, amended Playford, Willmott, and McKeellar, in McWhae and others, 1958), ranges in age from Middle Jurassic to Early Cretaceous; only the Cretaceous portion will be discussed here. Neocomian strata placed in the Yarragadee Formation occur in the Dandaragan Trough and Vlaming Sub-basin, the thickest development being offshore. The rocks consist predominantly of sandstone and siltstone and are

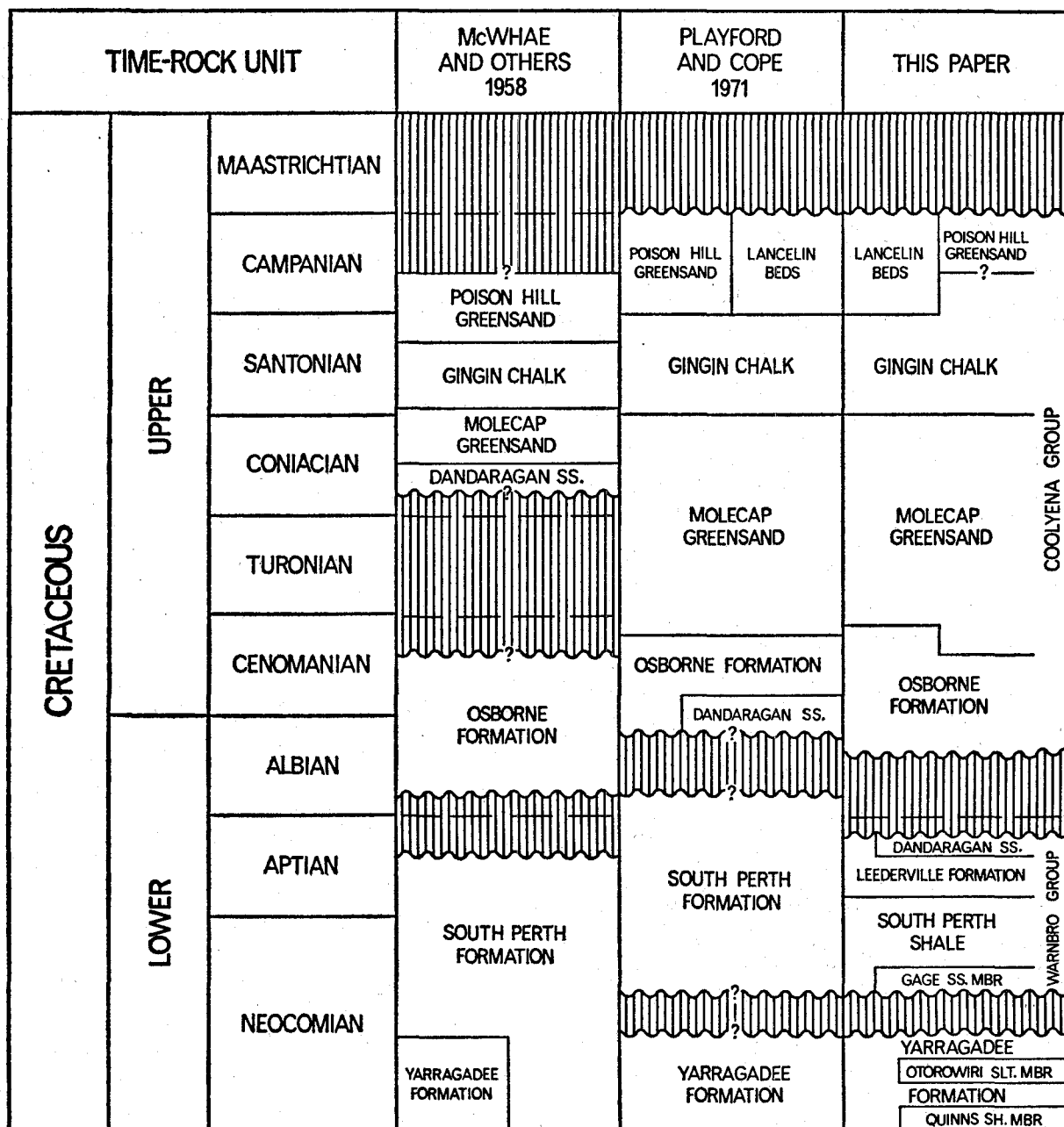

Figure 10. Cretaceous stratigraphic nomenclature, Perth Basin.

mainly continental onshore and partly marine offshore. Two members are recognized in the Neocomian part of the Yarragadee Formation, the Quinns Shale Member and the Otorowiri Siltstone Member.

The name *Quinns Shale Member* (Bozanic, 1969) has been used by Wapet geologists for a well-defined shale unit in the Yarragadee Formation in offshore wells in the central Perth Basin. The type section is between 1,590 m and 1,647 m in Quinns Rock No. 1 well (lat. 31° 48' 08" S long. 115° 30' 50" E). The member occurs in offshore wells between Quinns Rock No. 1 in the north and Sugarloaf No. 1 in the south and is a good seismic reflector. The microflora suggests that the Quinns Shale Member is a lagoonal deposit of earliest Neocomian age. The base of the member is taken to mark the Jurassic-Cretaceous boundary in the Perth Basin.

The *Otorowiri Siltstone Member* of Ingram (1967) is recognized in some of the Arrowsmith River water bores, west of Arrino in the northern Dandaragan Trough. The type section is in Arrowsmith River No. 25 bore between 253 m and 277 m (lat. 29° 33' 15" S, long. 115° 32' 00" E). The maximum known thickness is 37 m. The member consists predominantly of siltstone. It contains a rich assemblage of Early Cretaceous plant micro fossils, including microplankton, together with reworked forms of Devonian, Permian, Triassic and Jurassic age. The member is correlated on microfloral evidence with a group of shales in the Neocomian part of the Yarragadee Formation in offshore wells (A. Williams, pers. comm., 1972).

WARNBRO GROUP

The Warnbro Group is proposed herein for the South Perth Shale, Leederville Formation, and Dandaragan Sandstone. Warnbro No. 1 well between 1,003 m and 2,204 m is taken as the reference section for the group. The Warnbro Group includes the mixed marine and continental clastic sediments laid down during the Early Cretaceous transgression of the Perth Basin.

South Perth Shale (Fairbridge, 1953). The South Perth Shale is a shallow marine to continental sequence of interbedded shale and siltstone with minor sandstone. Calcareous beds, grading to limestone, are present in some areas. Sandstone is especially common at the base. The type section is in the South Perth No. 1 water bore (lat. 31° 58' 31" S, long. 115° 50' 57" E) between 497 m and 567 m (total depth). In the nearby South Perth No. 2 water bore the formation is overlain by the Leederville Formation. Neither well penetrated the underlying Upper Jurassic part of the Yarragadee Formation, which is known to occur below the South Perth Shale in other Perth Metropolitan water bores. In offshore wells Yarragadee Formation of Neocomian age underlies the South Perth Shale, and seismic work has shown that a major unconformity separates the two formations.

McWhae and others (1958) considered that it was impossible to separate the South Perth Shale from the Leederville Formation and combined the two formations under the name "South Perth Formation". However, subsequent work has shown that the two formations can be recognized, although the boundary between them is generally transitional.

The formation is best known in the subsurface and is not known to crop out with certainty. The South Perth Shale is well developed offshore in the Vlaming Sub-basin. It is 795 m thick in Warnbro No. 1 well and is probably even thicker farther west. Onshore the formation is virtually confined to the Perth Metropolitan area.

Early Cretaceous foraminiferal and microplankton assemblages are present in the formation (Coleman, 1952; Cookson and Eisenack, 1958). The microflora is referred to Balme's (1964) *Microcachyridites* assemblage, which is now thought to be predominantly of Early Cretaceous age (B. E. Balme, pers. comm., 1969).

In many wells and water bores the base of the South Perth Shale is sandy, as would be expected in the initial stages of a marine transgressive sequence. In offshore wells the basal sandstone has been named the *Gage Sandstone Member* (Bozanic, 1969). The type section is in Gage Roads No. 1 well (lat. 31° 57' 12" S, long. 115° 22' 38" E) between 1,588 m and 1,801 m, a thickness of 213 m. The unit consists of fine-grained to conglomeratic sandstone with minor siltstone and shale, and appears to have a near-shore marine origin. The Gage Sandstone Member has a known maximum thickness of 259 m (in Warnbro No. 1 well) and it yielded small but encouraging amounts of oil in Gage Roads No. 1 well.

Leederville Formation ("Leederville Sandstone" of Fairbridge, 1953). The Leederville Formation is a sequence of sandstone, frequently feldspathic and occasionally glauconitic, and conglomerate with siltstone and claystone. Sandstone predominates in some sections, but in others (including the type section) it is not the major constituent and for this reason the name of the unit is herein amended to Leederville Formation.

The type section is between 198 m and 433 m in the Leederville Valley water bore (lat. 31° 56' 05" S, long. 115° 49' 58" E) (Pudovskis, 1962), a total thickness of 235 m. The formation is overlain, probably unconformably, by the Kings Park Shale and rests, apparently conformably, on the South Perth Shale in the type section. The Leederville Formation is overlain by the Osborne Formation in part of the Perth Metropolitan area; the contact is probably disconformable, palynological evidence suggesting a short time break (B. S. Ingram, pers. comm., 1969).

The Leederville Formation is well developed in the subsurface of the Perth region, where it is about 250 m thick. Offshore it thickens to a known maximum thickness of 545 m (in Gage Roads No. 1 well). The Leederville Formation overlaps the underlying South Perth Shale both north and south of Perth and rests directly on the Yarragadee Formation. In Sugarloaf No. 1 well, the Leederville Formation rests on Neocomian Yarragadee Formation (Bird and Moyes, 1971); in onshore wells south of Pinjarra, the Leederville Formation unconformably overlies the Yarragadee and older formations.

The "Strathalbyn Sandstone", "Moochamullah Sandstone" (Playford and Willmott, 1958) and "Quindalup Beds" (Lowry, 1967) are now included in the Leederville Formation. In the Agaton water bores the formation was previously referred to as the "marine member of the South Perth Formation" (Passmore, 1969). Other possible correlatives of the Leederville Formation are the Dandaragan Sandstone, Bullsbrook Beds, Donnybrook Sandstone and Maxicar Beds.

Onshore the Leederville Formation is usually of continental facies and is unfossiliferous. However, in the Agaton area and in Sugarloaf No. 1 well it is marine and is of Neocomian-Aptian age according to the contained microplankton.

Dandaragan Sandstone ("Dandaragan Series", Blatchford, 1912 (lower part only); amended, Fairbridge, 1953). The Dandaragan Sandstone is a unit of massive to thickly bedded, ferruginous, feldspathic, medium to coarse-grained sandstone. It overlies the Yarragadee Formation with angular unconformity and is overlain with apparent conformity by the Molecap Greensand, although this contact is probably disconformable. The type section of the formation is 6 km west of Dandaragan (lat. 30° 41' 30" S, long. 115° 38' 30" E).

The Dandaragan Sandstone is exposed discontinuously between Badgingarra and Gingin. The type section is 33 m thick and is the thickest section measured to date. No fossils have been found in the formation other than fossil wood. It is believed to be of Early Cretaceous age because of its stratigraphic position, and to correlate possibly with the upper part of the Leederville Formation.

Bullsbrook Beds (Walkom, 1944). The Bullsbrook Beds are an interbedded sequence of poorly sorted sandstone and siltstone overlying Precambrian granitic rocks. The type section is at lat. 31° 39' 53" S, long. 116° 02' 40" E to the east of Bullsbrook. The Bullsbrook Beds are known only from the type area east of the Darling Fault where they are probably overlain by the Osborne Formation, although the contact is not exposed. Exposures to the west of the Darling Fault, previously mapped as Bullsbrook Beds (Low and Lake, 1970) are now assigned to the Osborne Formation. The unit was laid down in a valley incised into the Darling Scarp, probably during Early Cretaceous times, post-dating the last important period of movement along the Darling Fault.

Walkom (1944) reported the occurrence of fossil plants, including *Cladophlebis*, *Thinnfeldia* and *Elatocladus*, in the Bullsbrook Beds and tentatively suggested an Early Cretaceous age for the unit. It is not possible at present to be sure of the correlation of the Bullsbrook Beds with other Lower Cretaceous units in the Perth Basin, but they may correlate with the Leederville Sandstone.

Donnybrook Sandstone (Saint-Smith, 1912). The Donnybrook Sandstone is composed of yellow, fine to medium-grained feldspathic sandstone, which is generally only crudely bedded. The formation overlies Precambrian granitic rocks, and is overlain by laterite and other Quaternary deposits. The type section proposed by Playford and Willmott (1958) and Lowry (1965), is situated 6 km north of Donnybrook (lat. 33° 31' 19" S, long. 115° 49' 48" E). The formation is exposed in a belt 34 km long along the Darling Scarp north and south of Donnybrook. Outliers of the formation also occur 6 km to the east of the Darling Fault near Brookhampton and these rocks were deposited in an ancient valley eroded through the scarp. The thickest known exposure (about 61 m) occurs in this ancient valley; the type section is 40 m thick (Lowry, 1965).

The age of the Donnybrook Sandstone is indefinite but regional correlations suggest that it may be Early Cretaceous. Teichert (1947) reported footprints of a small quadruped from the formation near Brookhampton and he suggested that it might be of Triassic age. Balme (1956) recorded a Cretaceous microflora in a sample of carbonaceous siltstone from a shaft near Donnybrook, but this is now believed to be from the Leederville Formation. The Donnybrook Sandstone is probably equivalent to the Maxicar Beds and may correlate also with the Leederville Formation.

Maxicar Beds (Lowry, 1965; Playford and Low, 1972). The Maxicar Beds consist of current-bedded, medium to coarse-grained, feldspathic, ferruginous sandstone. The type section is at lat. 33° 24' 49" S, long. 115° 24' 49" E and the unit is exposed along the Darling Scarp in the vicinity of Maxicar homestead, about 19 km north of Donnybrook. The total thickness of the unit is unknown, but is at least 9 m.

The stratigraphic relationships of the Maxicar Beds are uncertain. The unit is believed to overlie Precambrian rocks directly, and it is probably laterally equivalent to the Donnybrook Sandstone. The beds were included in that formation by Playford and Willmott (1958).

A species of *Pterotrigonia* from the Maxicar Beds was identified by J. M. Dickins (pers. comm., 1957) and he considered it to be of Jurassic or Cretaceous age. An Early Cretaceous age for the unit now seems most likely on the basis of regional correlations.

COOLYENA GROUP.

The Coolyena Group is proposed herein for the Osborne Formation, Molecap Greensand, Gingin Chalk and Poison Hill Greensand (in ascending order). The name is taken from the Aboriginal name for Molecap Hill near Gingin. The Coolyena Group thus includes the marine glauconite-bearing beds of predominantly Late Cretaceous age occurring in the central part of the Perth Basin,

and is separated by a disconformity from the underlying Warnbro Group. The Lancelin Beds correlate with the upper part of the Coolyena Group. The maximum thickness of the group is 450 m in Warnbro No. 1 well.

Osborne Formation (McWhae and others, 1958). The Osborne Formation is a unit of interbedded sandstone (in part calcareous), siltstone, shale and claystone. The formation is characteristically glauconitic and the argillaceous sediments are usually dark grey to black. The formation overlies the Leederville Formation disconformably and is overlain disconformably by the Kings Park Shale in the Perth area. The type section of the formation is in the King Edward Street water bore (lat. 31° 54' 00" S, long. 115° 49' 00" E) from 37 m to 134 m.

The relationship between the Osborne Formation and the Molecap Greensand is not known with certainty. It is probable that the Molecap Greensand is equivalent to the uppermost part of the Osborne Formation. The two formations may be in conformable contact in some of the Agaton water bores; however, usually the two formations are not seen together and the Molecap Greensand is considerably thinner than the Osborne Formation and may represent the overlapping portion of the upper part of the Osborne Formation.

The Osborne Formation is known from bores in the Perth Metropolitan area, offshore in Warnbro No. 1, Sugarloaf No. 1 and Quinns Rock No. 1 wells, and extends in the subsurface as far north as Watheroo. Between Perth and Moora the formation also occurs as an outlier east of the Darling Fault. It crops out in the Moore River near Mogumber where the section was informally named the "Mogumber Formation" by Playford and Willmott (1958). The formation ranges from about 60 m to over 200 m in thickness.

The Osborne Formation contains a rich microflora, including microplankton which date it as Albian and Cenomanian (Cookson and Eisenack, 1958).

Molecap Greensand (Fairbridge, 1953). The Molecap Greensand consists of greensand and glauconitic quartz sandstone which rest with probable conformity on the Osborne Formation or disconformably on the Dandaragan Sandstone, and are overlain conformably by the Gingin Chalk. The type section is in the quarry on Molecap Hill near Gingin (lat. 31° 22' 00" S, long. 115° 24' 00" E). Two well developed phosphatic beds, each about 0.6 m thick, are present at the top and bottom of the formation in the Dandaragan area (Matheson, 1948). The formation is recognized in discontinuous exposures between Badgingarra and Gingin. At the type section the formation is 11 m thick and the average exposed thickness in the Gingin-Dandaragan area is between 10 m and 12 m.

Ichthyosaur and plesiosaur bones have been found in the formation (Teichert and Matheson, 1944), together with a few bivalves and belemnites. Defandre and Cookson (1955) report Late Cretaceous microplankton from the formation, and this dating has since been confirmed by B. S. Ingram (pers. comm., 1969).

Gingin Chalk (Glauert, 1910). The Gingin Chalk is a unit of white, friable, slightly glauconitic chalk, containing thin beds of greensand in some areas, which rests disconformably on the Dandaragan Sandstone or conformably on the Molecap Greensand, and is overlain conformably by the Poison Hill Greensand. The presence of a thin phosphatic horizon (well developed at Dandaragan, weak at Gingin) at the top of the Molecap Greensand may indicate that there has been a slight hiatus between deposition of the two formations. The type section is in MacIntyre Gully, 1.6 km north of Gingin (lat. 31° 19' 00" S, long. 115° 54' 00" E).

The Gingin Chalk is exposed in the area between Badgingarra and Gingin. It occurs in the subsurface as far north as Watheroo. The type section is 19 m thick, and the unit is usually about 18 m thick in most areas. The apparent absence of the Gingin Chalk in some places is commonly due to

landsliding, but there is evidence that it occasionally pinches out against the disconformity with the Dandaragan Sandstone.

The Gingin Chalk is richly fossiliferous, with a fauna of foraminifers (including the *Globotruncana lapparenti* group and *Rugoglobigerina* spp., Belford, 1960), the pelagic crinoids *Marsupites* and *Vintacrinus* (in the lower 6 m of the type section), abundant *Inoceramus* and other bivalves (Feldtmann, 1963), ammonites of the *Pachydiscus* type, ostracods, echinoids, brachiopods and abundant coccoliths (see further references in McWhae and others, 1958). The fossils indicate a Santonian (middle Senonian) age with the possibility that the upper part of the formation extends into the Campanian.

Poison Hill Greensand (Fairbridge, 1953). The Poison Hill Greensand is composed of greensand and glauconitic sandstone, which is crudely bedded and thick bedded. Exposures are commonly strongly lateritized. The formation rests conformably on the Gingin Chalk, and is overlain by laterite and associated Quaternary deposits. The type section is at Poison Hill near Gingin (lat. 31° 18' 00" S, long. 115° 53' 00" E). The formation is exposed in a belt from near Badgingarra to south of Gingin, and it also occurs in the subsurface as far north as the Watheroo area. The type section is 37 m thick, and the total maximum thickness of the formation probably exceeds 45 m (Playford and Willmott, 1958).

The Poison Hill Greensand has been dated as Late Cretaceous, based on an assemblage of pollen and microplankton from a shothole sample, but the precise age is in doubt (B. E. Balme, pers. comm., 1969). It is possible that the unit is a facies equivalent of the Campanian Lancelin Beds. Alternatively it may be younger than that unit.

Lancelin Beds (Edgell, 1964). The Lancelin Beds consist of light grey marl which underlies Quaternary sands in the Lancelin No. 2B water bore (lat. 31° 04' 00" S, long. 115° 19' 20" E). The unit is 14 m thick in this bore, extending from 32 m to 46 m (total depth). The Lancelin Beds are considered to be Campanian in age based on the foraminiferal fauna (especially the presence of *Bolivinooides granulatus* and *Neoflabellina praereticulata*; Edgell, 1964). If the Gingin Chalk is proved to extend into the Campanian, then the term Lancelin Beds can be dropped; however for the present the unit should be retained.

Bunbury Basalt ("Bunbury lava flow" of Saint-Smith, 1912; formally named by McWhae and others, 1958). The Bunbury Basalt is a flow of porphyritic or microporphyritic basalt (Edwards, 1938; Trendall, 1963). The rock is commonly vesicular, shows well developed columnar jointing in some areas and is dark grey to black in colour. Exposures of basalt on the beach at Bunbury may be taken as the type section (lat. 33° 19' 30" S, long. 115° 37' 40" E).

The Bunbury Basalt in surface exposures is overlain by Coastal Limestone, and the base is not exposed. In the subsurface it is overlain by the Warnbro Group with apparent conformity, and it rests on an erosional surface which is probably the unconformity at the top of the Yarragadee Formation. The basalt crops out in a number of areas from Bunbury to Black Point, extending as far east as the Darling Fault and as far west as the Scott River (Lowry, 1965). The thickest exposed section of the unit is 12 m, situated 1.6 km northeast of Black Point, while the thickest known subsurface section is 85 m, in the Boyanup bore..

Dolerite that intrudes the Sue Coal Measures in Sue No. 1 (J. E. Glover, in Williams and Nicholls, 1966) and Blackwood No. 1 wells may be comagmatic with the Bunbury Basalt. The occurrence in Sue No. 1 well has been dated as 136 ± 3 m.y. (written communication from B. M. R., 1972).

The Bunbury Basalt is believed to be of Early Cretaceous age. B. E. Balme (pers. comm., 1969) now believes on palynological grounds that the sediments immediately above the basalt flow in

Abba River No. 3 bore are of Early Cretaceous age, whereas the sediments unconformably below are Late Jurassic. The Bunbury Basalt is thought to represent a single flow which was spread along valleys eroded into the Yarragadee Formation prior to deposition of the Warnbro Group. The vent from which the flow was derived is unknown. This volcanism may have occurred during one of the last periods of movement along the Darling Fault in this area, and is probably related to the rupture of Gondwanaland.

REFERENCES

- Balme, B. E., 1956, Plant microfossils and the geological age of the Donnybrook Sandstone: *Australian Jour. Sci.*, v. 18, p. 127-128.
- 1964, The palynological record of Australian pre-Tertiary floras, in Cranwell (Ed.) *Ancient Pacific Floras*: Honolulu, Univ. Hawaii Press, p. 49-80.
- Belford, D. J., 1960, Upper Cretaceous foraminifera from the Toolonga Calcilitite and Gingin Chalk, Western Australia: *Australia Bur. Mineral Resources Bull.* 57.
- Bird, K. J., and Moyes, C. P., 1971, Sugarloaf No. 1 well completion report: West Australian Petroleum Pty. Ltd., Petroleum Search Subsidy Acts Rept. (unpublished).
- Blatchford, T., 1912, The possibility of obtaining artesian water in the vicinity of Moora: *West Australia Geol. Survey, Bull.* 3.
- Bozanic, D., 1969, Gage Roads No. 1 well completion report: West Australian Petroleum Pty. Ltd., Petroleum Search Subsidy Acts Rept. (unpublished).
- Coleman, P. J., 1952, Foraminiferal investigations in the Perth Basin, Western Australia: *Royal Soc. West. Australia Jour.* v. 36, p. 31-43.
- Cookson, I. C., and Eisenack, A., 1958, Microplankton from Australian and New Guinea Upper Mesozoic sediments: *Royal Soc. Victoria Proc.*, v. 70, p. 19-79.
- Deflandre, G., and Cookson, I. C., 1955, Fossil microplankton from Australian late Mesozoic and Tertiary sediments: *Australian Jour. Marine and Freshwater Research*, v. 6, p. 242-313.
- Edgell, H. S., 1964, The occurrence of Upper Cretaceous marine strata of Campanian age at Lancelin, Perth Basin: *West. Australia Geol. Survey Ann. Rept.*, 1963, p. 57-60.
- Edwards, A. B., 1938, Tertiary tholeiite magma in Western Australia: *Roy Soc. West. Australia Jour.*, v. 24, p. 1-12.
- Fairbridge, R. W., 1953, *Australian Stratigraphy*: Perth, Univ. West. Australia Textbooks Board, 516 pp.
- Feldtmann, F. R., 1963, Some pelecypods of the Cretaceous Gingin Chalk, Western Australia, together with descriptions of the principal chalk exposures: *Royal Soc. West. Australia Jour.*, v. 46, p. 101-125.
- Glauert, L., 1910, The geological age and organic remains of the Gingin Chalk: *West. Australia Geol. Survey Bull.* 36, p. 115-127.
- Ingram, B. S., 1967, Palynology of the Otorowiri Siltstone Member, Yarragadee Formation: *West. Australia Geol. Survey Ann. Rept.* 1966, p. 79-82.
- Low, G. H., and Lake, R. W., 1970, Perth and environs geological map sheet 1: *West. Australia Geol. Survey*.
- Lowry, D. C., 1965, Geology of the southern Perth Basin: *West. Australia Geol. Survey Rec.* 1965/17 (unpublished).
- 1967, Busselton and Augusta, W.A.: *West. Australia Geol. Survey 1: 250,000 Geol. Series Explan. Notes*.
- McWhae, J. R. H., Playford, P. E., Lindner, A. W., Glenister, B. F., and Balme, B. E., 1958, The stratigraphy of Western Australia: *Geol. Soc. Australia Jour.*, v. 4, pt. 2.

- Matheson, R. S., 1948, The Dandaragan phosphate deposits: West. Australia Geol. Survey Mineral Resources Bull. 4.
- Passmore, J. R., 1969, Exploratory drilling—Agaton project, Watheroo area, preliminary report: West Australia Geol. Survey Ann. Rept. 1968, p. 12-14.
- Playford, P. E., and Cope, R. N., 1971, The Phanerozoic stratigraphy of Western Australia. A correlation chart in two parts: West. Australia Geol. Survey Ann. Rept. 1970, p. 32-33.
- Playford, P. E., and Low, G. H., 1972, Definitions of some new and revised rock units in the Perth Basin: West. Australia Geol. Survey Ann. Rept. 1971, p. 44-46.
- Playford, P. E., and Willmott, S. P., 1958, Stratigraphy and structure of the Perth Basin, Western Australia: Unpublished report for West Australian Petroleum Pty. Ltd.
- Pudovskis, V., 1962, Subsurface geology of the Perth Metropolitan area: Unpublished report for West Australian Petroleum Pty. Ltd.
- Saint-Smith, E. C., 1912, A geological reconnaissance of a portion of the South-West Division of Western Australia: West. Australia Geol. Survey Bull. 44.
- Teichert, C., 1947, Stratigraphy of Western Australia: Royal Soc. New South Wales Jour. and Proc., v. 80, p. 81-142.
- Teichert, C., and Matheson, R. S., 1944, Upper Cretaceous Ichthyosaurian and Plesiosaurian remains from Western Australia: Australian Jour. Sci., v. 6, p. 167-170.
- Trendall, A. F., 1963, Petrologist's Report No. 33: West Australia Geol. Survey Rept. (unpublished).
- Walkom, A. B., 1944, Fossil plants from Gingin, Western Australia: Royal Soc. West. Australia Jour., v. 28, p. 201-207.
- Williams, C. T., and Nicholls, J., 1966, Sue No. 1 well completion report: West Australian Petroleum Pty. Ltd. Petroleum Search Subsidy Acts Rept. (unpublished).

PETROLEUM EXPLORATION IN WESTERN AUSTRALIA IN 1972

by G. H. Low

ABSTRACT

The tempo of oil exploration activity in Western Australia continued to increase during 1972, especially in the Northwest Shelf area. The B.O.C. group followed up earlier discovery wells on the North Rankin, Angel and Goodwyn fields with five successful extension tests. West Australian Petroleum Pty. Ltd. also was active in this area spudding three new field wildcat wells offshore, and one deeper pool test on Barrow Island, in addition to onshore wells in the Perth, Carnarvon and Canning Basins. Arco Australia Ltd. drilled four new field wildcat wells in the Bonaparte Gulf Basin, and Abrolhos Oil N. L. and Union Oil Development Corporation drilled new field wildcat wells in the northern Perth Basin and southern Perth Basin respectively.

Forty-five wells were drilled during the year and five were drilling at 31st December, for a total of 102,876 m of drilling. Geophysical activity also increased during the year, especially in marine seismic, aeromagnetic and ship-board gravity surveys. Several new petroleum concessions and special licenses were issued during the year.

INTRODUCTION

Petroleum exploration activity in Western Australia has steadily expanded over recent years and the trend continued in 1972. Exploratory drilling increased over the previous year as shown in the following tabulation:

	Wells completed		Wells drilling on 31st December	
	1971	1972	1971	1972
New field wildcat wells	22	22	1	4
Extension test wells	1	6	0	1
Deeper pool test wells	0	0	0	1
Stratigraphic wells	6	16	1	0
Total drilling: 1971—	70,620 m			
1972—	102,876 m			

One of the 1972 wildcat wells (Angel No. 1) made a gas and condensate discovery, and a significant oil discovery was made in another (Eaglehawk No. 1). Successful extension tests of fields discovered in 1971 were made in five wells (Angel No. 2, Goodwyn No. 2 and North Rankin Nos. 2, 3 and 4).

Test figures for gas given in the text are quoted in thousands of cubic metres per day ($\times 10^3$ m³/d). Oil and condensate test figures are quoted in barrels per day (b/d).

Geophysical survey activity also continued to increase, and surface geological investigations continued at a rate similar to that for 1971. The totals for 1972 are as follows:

Type of Survey	Line km	Party months or Geologist months
Land seismic	3,266
Marine seismic	43,218
Gravity (land)	10-45
Gravity (ship-board)	4,362
Aeromagnetic	26,445
Magnetic (ship-board)	5,019
Geological	13

A geochemical survey carried out during the year involved the collection of 265 samples over 106.5 line km.

PETROLEUM TENEMENTS

A number of new petroleum tenements were issued during the year, and the offshore tenement WA-22-P was relinquished by West Australian Petroleum Pty. Ltd. New tenements issued under the Petroleum (Submerged Lands) Act 1967 are in the offshore Bremer and Eucla Basins. New onshore tenements issued under the Petroleum Act 1967 are located in the Bremer, Perth, Carnarvon, Canning, Officer and Eucla Basins.

During 1972 authorities were granted to several companies for access to permits not held in their name, and to conduct scientific investigations in areas not currently held as tenements.

At the end of the year a number of applications were under consideration for areas gazetted as being available for issuing as exploration permits under the onshore petroleum act. Large areas in the sedimentary basins are currently available for application.

Petroleum tenements current on December 31st 1972 are shown on Figure 13, and the following tabulation lists details of the various holdings:

PETROLEUM TENEMENTS UNDER THE PETROLEUM (SUBMERGED LANDS) ACT 1967

Exploration Permits

Number	No. of grati-cular sections	Expiry date of current term	Registered holder or applicant
WA-1-P	364	14/11/74	Woodside Oil N.L., Shell Development (Australia) Pty. Ltd., B.O.C. of Australia Ltd.
WA-2-P	381	14/11/74	West Australian Petroleum Pty. Ltd.
WA-7-P	135	10/7/75	Continental Oil Co. of Aust. Ltd.
WA-8-P	18	17/6/75	Coastal Petroleum N.L.
WA-9-P	56	17/6/75	" " " " " " " "
WA-10-P	36	15/6/75	" " " " " " " "
WA-12-P	5	11/9/75	Associated Australian Oilfields N.L.
WA-13-P	387	29/8/74	West Australian Petroleum Pty. Ltd.
WA-14-P	396	29/8/74	" " " " " " " "
WA-15-P	352	20/3/75	Arco Aust. Ltd., Australian Aquitaine Petroleum Pty., Aust. Ltd., Esso Exploration & Production Aust. Inc.
WA-16-P	354	16/4/75	" " " " " " " "
WA-17-P	378	22/4/75	" " " " " " " "
WA-18-P	322	16/4/75	" " " " " " " "
WA-19-P	142	20/3/75	Alliance Oil Development Australia N.L.
WA-20-P	34	10/10/74	West Australian Petroleum Pty. Ltd.
WA-21-P	241	14/11/74	" " " " " " " "
WA-23-P	398	3/10/74	" " " " " " " "
WA-24-P	208	17/10/74	" " " " " " " "
WA-25-P	256	16/10/74	" " " " " " " "
WA-26-P	400	22/12/74	Canadian Superior Oil (Aust.) Pty. Ltd., Australian Superior Oil Co. Ltd., Philips Australian Oil Co. Ltd., Sunray Australian Oil Co. Inc.
WA-27-P	294	18/5/75	" " " " " " " "
WA-28-P	375	24/3/75	Woodside Oil N.L., Shell Development (Australia) Pty. Ltd., B.O.C. of Australia Ltd.
WA-29-P	400	18/5/75	" " " " " " " "
WA-30-P	400	2/7/75	" " " " " " " "
WA-31-P	400	18/5/75	" " " " " " " "
WA-32-P	395	2/7/75	" " " " " " " "
WA-33-P	389	18/5/75	" " " " " " " "
WA-34-P	397	2/7/75	" " " " " " " "
WA-35-P	400	2/7/75	" " " " " " " "
WA-36-P	57	18/5/75	" " " " " " " "
WA-37-P	118	2/8/75	" " " " " " " "
WA-39-P	104	12/3/75	B.P. Petroleum Development Australia Pty. Ltd., Abrothos Oil N.L.
WA-40-P	102	12/3/75	" " " " " " " "
WA-41-P	33	15/6/75	Coastal Petroleum N.L.
WA-43-P	241	17/9/78	Planet Exploration Company Pty. Ltd.
WA-44-P	400	17/9/78	" " " " " " " "
WA-47-P	195	5/8/78	Continental Oil Co. of Aust. Ltd.
WA-50-P	330	23/7/78	Esso Exploration & Production Aust. Inc.
WA-51-P	278	25/7/78	" " " " " " " "

PETROLEUM TENEMENTS UNDER THE PETROLEUM ACT 1936

Petroleum Leases

Number	Area (square miles)	Expiry date of current term	Holders
IH	100	9/2/88	West Australian Petroleum Pty. Ltd.
2H	100	9/2/88	" " " " " " " "

PETROLEUM TENEMENTS UNDER THE PETROLEUM ACT 1967

Exploration Permits

Number	No. of grati-cular sections	Expiry date of current term	Registered holder or applicant
EP 3	200	27/8/75	West Australian Petroleum Pty. Ltd.
EP 5	132	26/7/75	" " " " " " " "
EP 6	199	27/8/75	" " " " " " " "
EP 7	200	27/8/75	" " " " " " " "
EP 8	200	8/8/77	" " " " " " " "
EP 9	200	27/8/75	" " " " " " " "
EP 12	182	3/9/75	" " " " " " " "
EP 13	200	27/8/75	" " " " " " " "
EP 14	200	27/8/75	" " " " " " " "
EP 15	200	27/8/75	" " " " " " " "
EP 16	200	27/8/75	" " " " " " " "
EP 17	200	27/8/75	" " " " " " " "
EP 18	200	27/8/75	" " " " " " " "
EP 19	200	27/8/75	" " " " " " " "
EP 20	200	8/8/77	Australian Aquitaine Petroleum Pty. Ltd.
EP 21	90	26/7/75	West Australian Petroleum Pty. Ltd.
EP 23	163	6/8/75	" " " " " " " "
EP 24	167	6/8/75	" " " " " " " "
EP 25	96	6/8/75	" " " " " " " "
EP 26	1	27/8/75	BP Petroleum Development, Abrothos Oil N.L.
EP 27	2	19/8/75	" " " " " " " "
EP 28	4	19/8/75	" " " " " " " "
EP 29	7	19/8/75	" " " " " " " "

Number	No. of grati-cular sections	Expiry date of current term	Registered holder or applicant
EP 31	200	6/10/75	Beach-General Exploration Pty. Ltd., Australian Aquitaine Petroleum Pty. Ltd.
EP 32	200	15/4/76	" " " " " " " "
EP 33	123	15/4/76	" " " " " " " "
EP 34	1	15/4/76	Woodside Oil N.L., Shell Development (Australia) Pty. Ltd., B.O.C. of Australia Ltd.
EP 35	1	15/4/76	" " " " " " " "
EP 36	1	15/4/76	" " " " " " " "
EP 37	149	22/9/75	West Australian Petroleum Pty. Ltd.
EP 38	130	22/9/75	" " " " " " " "
EP 39	160	22/9/75	" " " " " " " "
EP 40	87	26/7/76	" " " " " " " "
EP 41	180	18/7/76	" " " " " " " "
EP 42	200	1/9/75	" " " " " " " "
EP 43	163	1/9/75	" " " " " " " "
EP 44	113	1/9/75	" " " " " " " "
EP 45	197	19/11/75	Continental Oil Co. of Aust. Ltd., Australian Sun Oil Co. Ltd.
EP 46	199	1/9/75	" " " " " " " "
EP 47	199	19/11/75	" " " " " " " "
EP 48	199	19/11/75	" " " " " " " "
EP 50	110	1/9/75	West Australian Petroleum Pty. Ltd.
EP 51	17	8/9/75	Lennard Oil N.L.
EP 52	18	8/9/75	" " " " " " " "
EP 53	49	15/9/75	West Australian Petroleum Pty. Ltd.
EP 54	123	22/9/75	Alliance Oil Development Aust. N.L.
EP 55	178	22/9/75	West Australian Petroleum Pty. Ltd.
EP 58	200	20/7/76	Associated Australian Oilfields N.L., Australian Aquitaine Petroleum Pty. Ltd., Abrothos Oil N.L., Ashburton Oil N.L., Flinders Petroleum N.L., Longreach Oil Ltd., Pursuit Oil N.L.
EP 59	186	18/7/76	" " " " " " " "
EP 60	2	" " " " " " " "	West Australian Petroleum Pty. Ltd.
EP 61	4	19/9/76	" " " " " " " "
EP 62	8	19/9/76	" " " " " " " "
EP 63	4	19/9/76	" " " " " " " "
EP 64	1	" " " " " " " "	" " " " " " " "
EP 65	2	19/9/76	" " " " " " " "
EP 66	1	19/9/76	" " " " " " " "
EP 67	29	25/10/76	" " " " " " " "
EP 68	175	27/7/77	W. I. Robinson
EP 69	82	5/4/77	Sunningdale Oils Pty. Ltd.
EP 70	71	25/9/77	Associated Australian Oilfields N.L., Australian Aquitaine Petroleum Pty. Ltd., Abrothos Oil N.L., Ashburton Oil N.L., Flinders Petroleum N.L., Longreach Oil Ltd., Pursuit Oil N.L.
EP 71	81	6/7/77	Coastal Petroleum N.L.
EP 72	198	21/8/77	Planet Exploration Company Pty. Ltd.
EP 73	198	21/8/77	" " " " " " " "
EP 75	198	21/8/77	" " " " " " " "
EP 76	188	23/7/77	Genoa Oil N.L., Hartog Oil N.L., Olympus Petroleum N.L., Pexa Oil N.L., Omega Oil N.L., Kambalda Petroleum N.L.
EP 77	135	Appl'n	Stannon Engineering Co. Pty. Ltd.
EP 78	174	Appl'n	Planet Exploration Company Pty. Ltd.
EP 79	180	Appl'n	" " " " " " " "
EP 80	180	Appl'n	" " " " " " " "
EP 81	468	Appl'n	Officer Exploration Pty. Ltd.
EP 82	47	Appl'n	" " " " " " " "

Production Licences

Number	No. of grati-cular sections	Expiry date of current term	Registered holder or applicant
PL 1	5	24/10/92	West Australian Petroleum Pty. Ltd.
PL 2	4	24/10/92	" " " " " " " "
PL 3	5	24/10/92	" " " " " " " "

PETROLEUM TENEMENTS UNDER THE PETROLEUM PIPELINES ACT, 1969

Pipeline Licences

Number	Expiry date of current term	Registered holder or applicant
1	1/12/91	California Asiatic Oil Co., Texaco Overseas Petroleum Co., Shell Development (Australia) Pty. Ltd., Ampol Exploration Ltd.
2	1/12/91	" " " " " " " "
3	1/12/91	" " " " " " " "
4	1/12/91	" " " " " " " "
5	1/12/91	" " " " " " " "

DRILLING

The positions of wells drilled for petroleum exploration in Western Australia during 1972 are shown on Figures 11 and 12. Details relating to the wells drilled during the year are given in Table 7. All of the petroleum exploration wells drilled in Western Australia up to the end of 1972 are listed in Geological Survey Record 1973/5.

A summary of the principal results of drilling in each basin during the year is as follows:

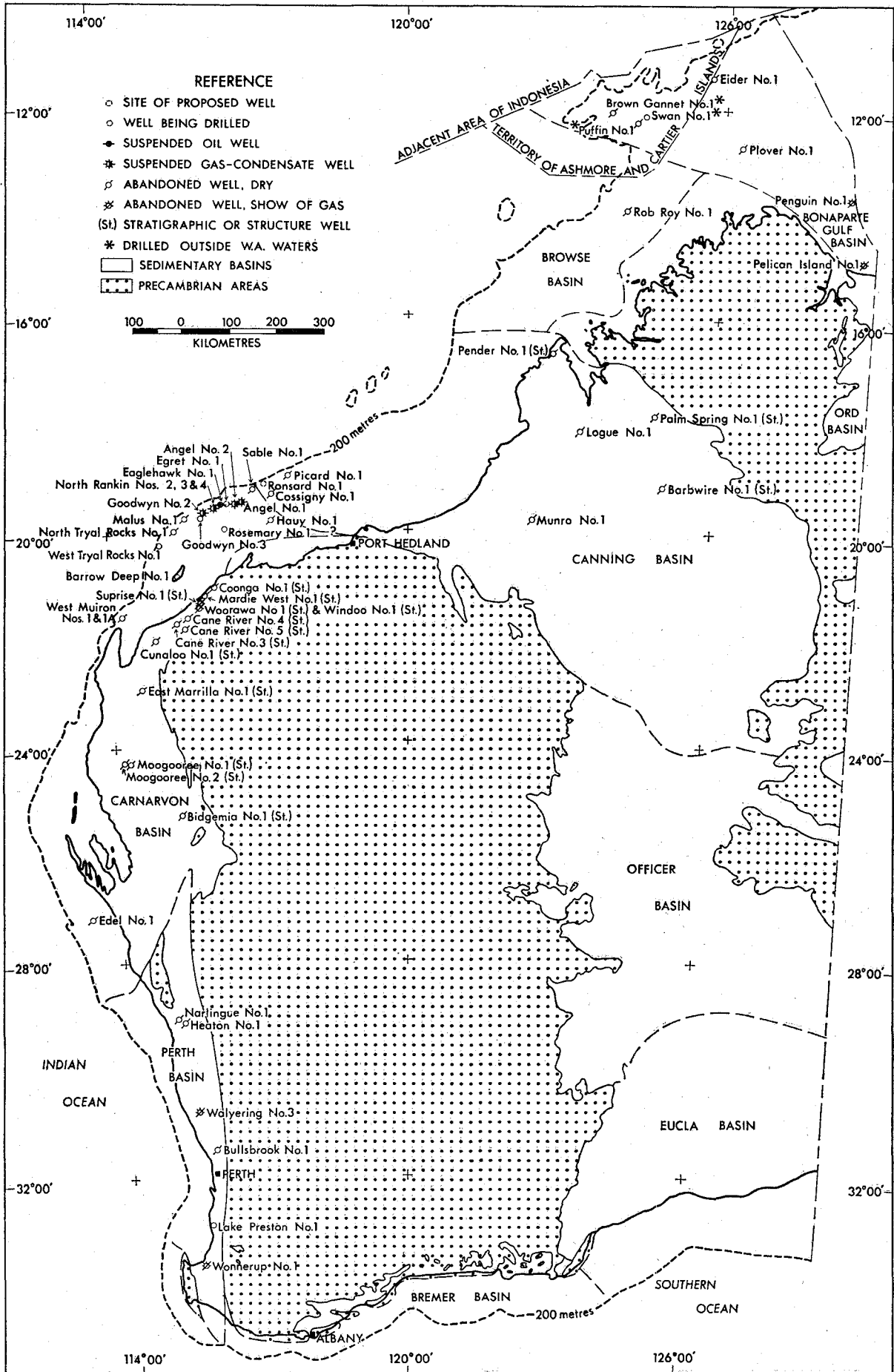

Figure II. Wells drilled for petroleum exploration in W.A. during 1972.

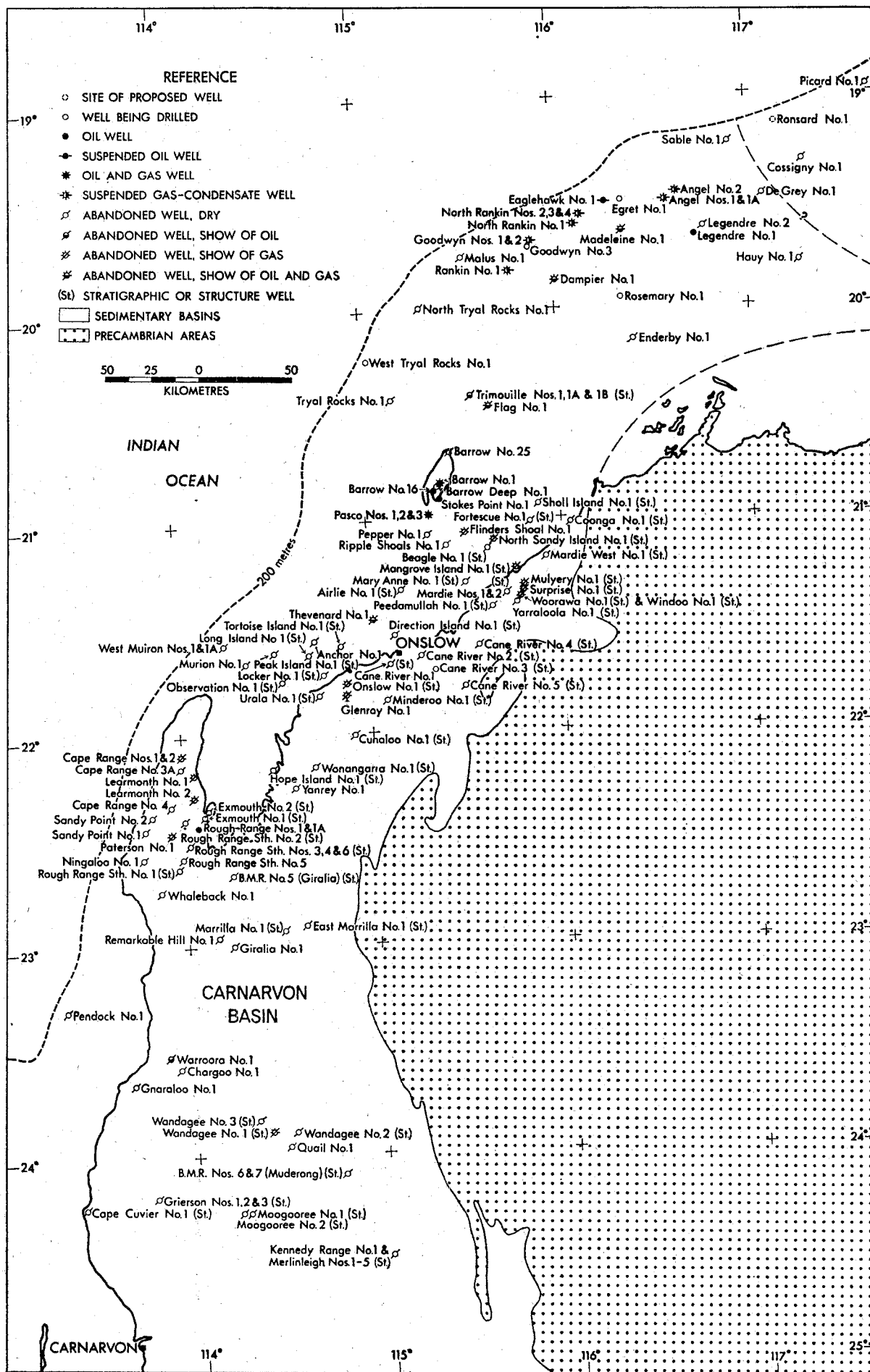

Figure 12. Wells drilled for petroleum exploration in the northern Carnarvon and southern Canning Basins to the end of 1972.

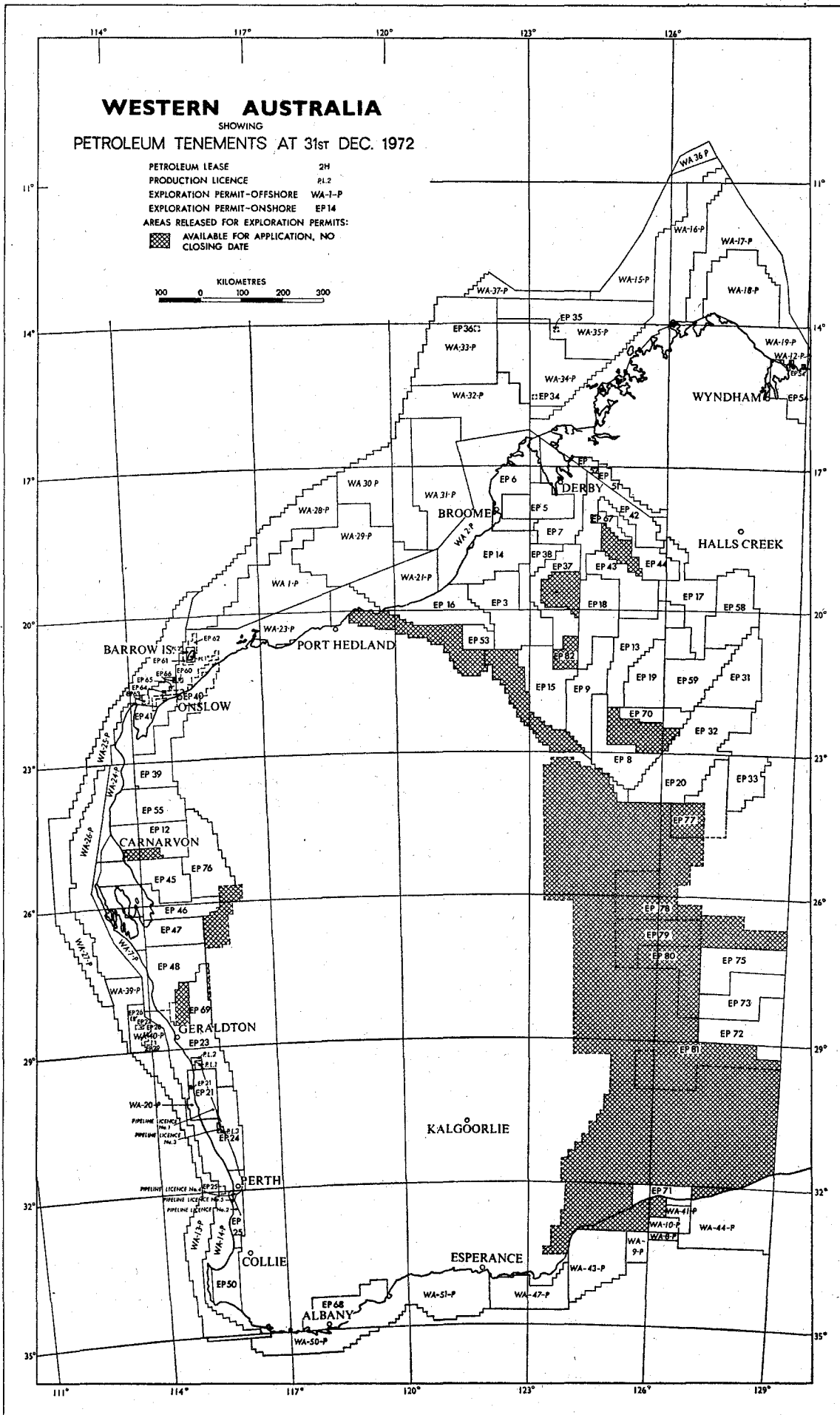

Figure 13. Petroleum tenements on 31st December, 1972.

TABLE 7. WELLS DRILLED FOR PETROLEUM EXPLORATION IN WESTERN AUSTRALIA DURING 1972

Basin	Well	* = Subsidized	Concession	Operating Company	Type	Position		Elevation and water depth (in metres)			Dates			Total depth (or depth reached) in metres	Bottomed in	Status 31 Dec. 1972
						Latitude South ° ' "	Longitude East ° ' "	G.L.	D.F.	W.D.	Com-menced	Reached T.D.	Rig. released			
Perth	Walying No. 3		EP-24	WAPET	EXT	30 44 01	115 29 33	91.4	96.0	16/1/72	28/4/72	9/5/72	4,187	Gas shows P & A
	Narlingue No. 1	*	EP-23	ABROL	NFW	29 04 14	115 06 10	192.9	196.6	27/3/72	24/4/72	26/4/72	2,130	L. Permian	Dry, P & A
	Wonnerup No. 1	*	EP-50	UNION	NFW	33 37 55	115 28 16	15.9	24.1	18/4/72	3/8/72	9/8/72	4,727	U. Permian	Gas shows P & A
	Heaton No. 1	*	EP-23	ABROL	NFW	29 07 18	115 12 45	185.6	190.5	3/5/72	24/5/72	25/5/72	2,438	L. Permian	Dry, P & A
	Bullsbrook No. 1	*	EP-24	WAPET	NFW	31 28 41	115 50 28	86.3	90.8	1/10/72	27/11/72	30/11/72	4,257	L. Jurassic	Dry, P & A
Lake Preston No. 1	*	EP-25	WAPET	NFW	32 55 13	115 39 32	10.1	14.6	20/12/72	1,384	Drilling	
Carnarvon	Cane River No. 3	*	EP-40	HEMAT	STR	21 42 28	115 19 29	14.9	17.7	29/12/71	2/1/72	3/1/72	255	Dry, P & A
	Angel No. 1	*	WA-1-P	B.O.C.	NFW	19 30 20	116 35 48	9.4	79.8	12/10/71	11/1/72	22/1/72	3,671	U. Jurassic	G & C discovery Suspended
	Cane River No. 4		EP-40	HEMAT	STR	21 35 54	115 33 45	13.1	15.9	16/1/72	21/1/72	21/1/72	173	Dry, P & A
	Cane River No. 5		EP-40	HEMAT	STR	21 47 22	115 28 48	34.1	36.9	8/1/72	10/1/72	11/1/72	201	Dry, P & A
	Angel No. 2	*	WA-1-P	B.O.C.	EXT	19 27 58	116 39 25	9.4	86.5	7/3/72	20/5/72	2/6/72	4,397	L. Jurassic	G & C well, Suspended
	Goodwyn No. 2		WA-28-P	B.O.C.	EXT	19 39 53	115 51 53	12.5	133.9	27/3/72	28/5/72	6/6/72	4,036	G & C well, Suspended
	Cunaroo No. 1	*	EP-39	WAPET	STR	22 00 48	114 53 47	12.3	15.2	22/3/72	31/3/72	1/4/72	797	U. Permian	Dry, P & A
	East Marrilla No. 1	*	EP-39	WAPET	STR	22 54 48	114 36 58	59.1	62.2	15/4/72	25/4/72	26/4/72	638	L. Carboniferous	Dry, P & A
	North Tryal Rocks No. 1	*	WA-25-P	WAPET	NFW	19 59 17	115 19 11	12.2	106.7	3/6/72	28/7/72	5/8/72	3,658	M. Triassic	Dry, P & A
	Edel No. 1	*	WA-26-P	OCEAN	NFW	27 06 46	113 23 22	29.5	94.5	24/5/72	20/7/72	25/5/72	2,749	Triassic	Dry, P & A
	North Rankin No. 2		WA-28-P	B.O.C.	EXT	19 33 54	116 08 48	12.5	126.2	9/6/72	1/8/72	20/8/72	3,750	G & C well Suspended
	Sable No. 1	*	WA-1-P	B.O.C.	NFW	19 14 04	116 54 59	22.5	140.8	21/8/72	12/10/72	14/10/72	3,647	?U. Triassic	Dry, P & A
	North Rankin No. 3		WA-28-P	B.O.C.	EXT	19 31 49	116 10 21	29.3	125.0	4/8/72	14/9/72	28/9/72	4,093	G & C well Suspended
	Barrow Deep No. 1	*	PL-1H	WAPET	DPT	20 50 07	115 22 57	38.7	46.6	16/9/72	3,238	Drilling
	West Muiron No. 1	*	WA-25-P	WAPET	NFW	21 33 56	114 14 41	12.2	142.0	16/8/72	18/9/72	4/10/72	781	U. Cretaceous	Dry, P & A
West Muiron No. 1A	*	WA-25-P	WAPET	NFW	21 34 14	114 14 45	12.2	62.5	5/10/72	18/10/72	21/10/72	345	Tertiary	Dry, P & A	
North Rankin No. 4		WA-28-P	B.O.C.	EXT	19 35 07	116 06 42	30.2	127.1	30/9/72	11/11/72	23/11/72	4,062	G & C well Suspended	
West Tryal Rocks No. 1	*	WA-26-P	WAPET	NFW	20 13 45	115 02 04	12.2	137.8	23/10/72	3,091	Drilling	
Malus No. 1	*	WA-28-P	B.O.C.	NFW	19 45 16	115 32 03	9.7	85.6	7/10/72	6/11/72	3,658	U. Triassic	Dry, P & A	
Moogooree No. 1		EP-76	HARTOG	STR	24 15 20	115 15 30	253.0	253.6	8/10/72	15/10/72	15/10/72	128	Dry, P & A	

Carnarvon	Moogooree No. 2	EP-76	HARTOG	STR	24 16 50	115 12 40	257.5	258.1	18/10/72	27/10/72	4/11/72	192	Dry, P & A
	Woorawa No. 1	EP-40	HEMAT	STR	21 21 55	115 47 33	13.4	15.5	14/9/72	27/9/72	4/10/72	202	Gas show P & A
	Windoo No. 1	EP-40	HEMAT	STR	21 21 18	115 46 55	2.1	4.3	17/10/72	22/10/72	31/10/72	218	Gas show P & A
	Surprise No. 1	EP-40	HEMAT	STR	21 17 58	115 49 27	9.7	11.9	14/11/72	28/11/72	1/12/72	216	Gas show P & A
	Mardie West No. 1	EP-40	HEMAT	STR	21 11 56	115 55 24	6.4	8.5	5/12/72	8/12/72	11/12/72	135	Dry, P & A
	Coonga No. 1	EP-40	HEMAT	STR	21 03 08	116 01 48	5.8	7.9	14/12/72	19/12/72	20/12/72	176	Dry, P & A
	Bidgemia No. 1	EP-76	HARTOG	STR	25 16 00	115 20 20	201.7	202.2	6/11/72	23/11/72	23/11/72	228	Dry, P & A
	Eaglehawk No. 1	WA-1-P	B.O.C.	NFW	19 30 30	116 16 37	12.5	120.1	10/11/72	14/12/72	24/12/72	3,490	U. Triassic	Oil dis- covery Sus- pended
	Rosemary No. 1	WA-1-P	B.O.C.	NFW	19 57 16	116 20 41	9.5	64.9	13/11/72	2,845	Drilling
	Hauy No. 1	WA-1-P	B.O.C.	NFW	19 47 39	117 15 15	30.1	65.5	25/11/72	8/12/72	14/12/72	825	Precambrian	Dry, P & A
Goodwyn No. 3	WA-28-P	B.O.C.	EXT	19 44 9	115 52 43	30.1	118.8	16/12/72	2,591	Drilling	
Egret No. 1	WA-28-P	B.O.C.	NFW	19 30 24	116 20 52	12.5	118.2	24/12/72	1,292	Drilling	
Canning	Munro No. 1	EP-3	WAPET	NFW	19 51 55	122 29 19	51.2	55.8	4/6/72	30/6/72	3/7/72	2,116	Precambrian	Dry, P & A
	Pender No. 1	EP-6	WAPET	STR	16 40 48	122 50 06	21.0	24.1	15/5/72	21/5/72	22/5/72	912	L. Permian	Dry, P & A
	Barbwire No. 1	EP-43	WAPET	STR	19 10 38	125 00 59	215.5	218.5	18/6/72	6/7/72	6/7/72	774	M. Ordovician	Dry, P & A
	Palm Spring No. 1	EP-42	WAPET	STR	17 48 56	124 53 08	117.9	121.0	31/5/72	11/6/72	12/6/72	1,067	U. Devonian	Dry, P & A
	Picard No. 1	WA-1-P	B.O.C.	NFW	18 58 00	117 37 20	9.4	141.7	29/7/72	23/9/72	3/10/72	4,216	L. Jurassic	Dry, P & A
	Cossigny No. 1	WA-1-P	B.O.C.	NFW	19 19 53	117 17 26	12.8	111.5	15/10/72	5/11/72	8/11/72	3,203	?U. Triassic	Dry, P & A
	Logue No. 1	EP-7	WAPET	NFW	18 07 33	123 23 25	53.9	58.6	17/7/72	31/8/72	3/9/72	2,699	U. Devonian	Dry, P & A
Browse	Rob Roy No. 1	WA-35-P	B.O.C.	NFW	13 58 16	124 11 57	9.4	102.1	27/1/72	25/2/72	28/2/72	2,286	Precambrian	Dry, P & A
Bonaparte Gulf	Pelican Island No. 1	EP-54	ARCO	NFW	14 46 19	128 46 27	7.9	12.2	29/5/72	27/7/72	29/7/72	1,981	Gas shows P & A
	Penguin No. 1	WA-17-P	ARCO	NFW	13 36 28	128 28 06	34.4	68.5	22/6/72	23/7/72	29/7/72	2,757	Gas shows P & A
	Eider No. 1	WA-15-P	ARCO	NFW	11 23 21	125 44 47	34.1	99.9	6/8/72	16/9/72	30/9/72	2,835	Dry, P & A
	Plover No. 1	WA-16-P	ARCO	NFW	12 42 45	126 22 07	34.0	57.9	10/11/72	14/12/72	17/12/72	2,438	Dry, P & A
Total													106,185		
Less drilling done in 1971													3,309		
Total drilling done in 1972													102,876		

ABROL = Abrolhos Oil N.L.
 ARCO = Arco Australia Ltd.
 B.O.C. = B.O.C. of Australia Ltd.
 HARTOG = Hartogen Explorations Pty. Ltd.
 HEMAT = Hematite Petroleum Pty. Ltd.
 OCEAN = Ocean Ventures Pty. Ltd.
 UNION = Union Oil Development Corp.

WAPET = West Australian Petroleum Pty. Ltd.
 DPT = Deeper Pool Test
 EXT = Extension test well
 NFW = New field wildcat well
 P & A = Plugged and abandoned
 STR = Stratigraphic well
 G & C = Gas and condensate

PERTH BASIN

The results of drilling in the Perth Basin in 1972 were disappointing. Four test wells were drilled but, with the exception of Wonnerup No. 1 which yielded minor gas shows from Upper Permian sediments, all were dry. Some gas shows were encountered in the extension test well Walyering No. 3 but these were uneconomic and the well was plugged and abandoned.

The Lake Preston No. 1 new field wildcat well was drilling in the southern Perth Basin at the end of the year.

CARNARVON BASIN

Thirteen wells were spudded by the B.O.C. group in the Carnarvon Basin during 1972. Seven were new field wildcat wells and of these Angel No. 1 was a gas and condensate discovery, and Eaglehawk No. 1 was an oil discovery. The remaining six were extension tests. Five of these (Angel No. 2, Goodwyn No. 2, and North Rankin Nos. 2, 3 and 4) were successful gas and condensate wells and the other one, Goodwyn No. 3, was drilling at the end of the year.

Wapet spudded three new field wildcats. North Tryal Rocks No. 1 and West Muiron No. 1A were both dry and were plugged and abandoned, and West Tryal Rocks No. 1 was drilling at the end of the year. Electric logging has revealed indications of hydrocarbons in four zones totalling 46 m in this well. The deeper pool test Barrow Deep No. 1 was also drilling at the year's end, and promising indications of hydrocarbons have been encountered below 3,228 m.

Edel No. 1, a new field wildcat drilled offshore in the southern Carnarvon Basin by Ocean Ventures Pty. Ltd., was abandoned as a dry hole after reaching total depth in interbedded sandstones, siltstones and volcanics of probable Triassic age.

Two onshore stratigraphic wells, Cunaloo No. 1 and East Marrilla No. 1, were drilled by Wapet. Hematite Petroleum Pty. Ltd. drilled five shallow stratigraphic wells in EP-40 (under a farmout from Wapet), and Hartogen Exploration Pty. Ltd. drilled three shallow stratigraphic wells in EP-76.

The results obtained in the extension test wells in the Angel, Goodwyn and North Rankin fields are discussed in a separate report on petroleum development and production in 1972 (p. 40). Some details of the discovery wells are as follows:

Angel No. 1

Log evaluation and tests show that Upper Jurassic sands in the Barrow Group contain about 85 m gross hydrocarbon pay. This is wet gas with a condensate-to-gas ratio of about 1.8 barrels per thousand cubic metres of gas. The following is a summary of the results of the two drill stem tests run in the hole on a $\frac{3}{8}$ -inch bottom choke:

D.S.T. No.	Interval (metres)	Surface Choke	Gas x 10 ³ m ³ /d	Condensate b/d	Water b/d
1	2,734-2,737	$\frac{3}{8}$ inch	363.9	720	trace
2	2,685-2,688	$\frac{3}{8}$ inch	373.8	686	trace

Eaglehawk No. 1

Drill stem tests of Upper Triassic sands in Eaglehawk No. 1 yielded oil of 29.3 A.P.I. gravity, which is heavier than other oils recovered to date in Western Australia. A summary of the tests (through a $\frac{3}{8}$ -inch bottom choke) is as follows:—

D.S.T. No.	Interval (metres)	Surface Choke	Gas x 10 ³ m ³ /d	Oil b/d	Water b/d
1	2,777-2,788	nil	233	571
2	2,750-2,766	$\frac{3}{8}$ inch	3.99	1,645	nil

CANNING BASIN

During the year two offshore new field wildcat wells, two onshore new field wildcat wells, and three onshore stratigraphic wells were drilled in the Canning Basin. All were dry and were plugged and abandoned. The offshore wells, Picard No. 1 and Cossigny No. 1 were the first drilled in the Beagle Sub-basin in the southwestern Canning Basin.

BROWSE BASIN

Only one well, the new field wildcat Rob Roy No. 1, was drilled in the Browse Basin during 1972. The well penetrated Recent, Tertiary, Mesozoic, and Permian sediments before reaching total depth in Proterozoic quartzite. It was abandoned as a dry well.

BONAPARTE GULF BASIN

Four new field wildcat wells were drilled by Arco during the year in the part of the Bonaparte Gulf Basin under Western Australian control. All were abandoned as dry holes but there were some small gas shows in Pelican Island No. 1 and Penguin No. 1.

GEOPHYSICAL SURVEYS

SEISMIC

During 1972, seismic surveys were conducted in the Perth, Carnarvon, Canning, Browse, Bonaparte Gulf and Bremer Basins. Details are as follows:

SEISMIC SURVEYS

Basin	Permit No.	Company	Line Kilometres	
			Marine	Land
Perth	EP-21	West Australian Petroleum Pty. Ltd.	140
	EP-23	" " "	45
	EP-24	" " "	446
	EP-25	" " "	188
	WA-13-P	" " "	929
	WA-14-P	" " "	559
	WA-20-P	" " "	32
	WA-40-P	BP Petroleum Dev. Aust. Pty. Ltd.	224
Carnarvon	EP-12	West Australian Petroleum Pty. Ltd.	119
	EP-55	" " "	103
	EP-47	Continental Oil Co. of Aust. Ltd.	72
	EP-48	" " "	7
	WA-39-P	BP Petroleum Dev. Aust. Pty. Ltd.	814
	WA-23-P	West Australian Petroleum Pty. Ltd.	430
	WA-24-P	" " "	558
	WA-75-P	" " "	2579
	EP-41	" " "	27
	WA-26-P	Canadian Superior Oil (Aust.) Pty. Ltd.	1187
	WA-7-P	Continental Oil Co. of Aust. Ltd.	415
Carnarvon/Canning	WA-1-P	B.O.C. of Australia Ltd.	1199
	WA-28-P	" " "	1877
Canning	EP-5	West Australian Petroleum Pty. Ltd.	129
	EP-6	" " "	5	6
	EP-7	" " "	117
	EP-13	" " "	48
	EP-14	" " "	108
	EP-17	" " "	34
	EP-18	" " "	119
	EP-19	" " "	9
	EP-37	" " "	101
	EP-38	" " "	68
	EP-42	" " "	219
	EP-43	" " "	565
	EP-44	" " "	352
	EP-67	" " "	61
	EP-20	Australian Aquitaine Petroleum Pty. Ltd.	130
	EP-33	" " "	80
	WA-2-P	West Australian Petroleum Pty. Ltd.	419
	WA-21-P	" " "	1064
	WA-29-P	B.O.C. of Australia Ltd.	2461
WA-31-P	" " "	700	
WA-31-P	Amx Petroleum (Aust.) Inc.	990	
WA-30-P	Shell Development (Aust.) Pty. Ltd.	1803	
WA-30-P	Hematite Petroleum Pty. Ltd.	1442	
Browse	WA-32-P	B.O.C. of Australia Ltd.	1149
	WA-33-P	" " "	191
	WA-34-P	" " "	1757
	WA-35-P	" " "	666
	WA-37-P	" " "	53
Bonaparte Gulf	WA-15-P	Arco Australia Ltd.	4025
	WA-16-P	" " "	4826
	WA-17-P	" " "	4776
	WA-18-P	" " "	4189
	WA-19-P	" " "	436
	EP-54	" " "	495
	WA-12-P	Australian Aquitaine Petroleum Pty. Ltd.	3
Bremer	WA-47-P	Continental Oil Co. of Aust. Ltd.	958
Totals			43,218	3,266

GRAVITY

Gravity surveys were carried out during the year in the Perth, Carnarvon, and Canning Basins, and the majority of these were shipboard. Details are as follows:

GRAVITY SURVEYS

Basin	Permit No.	Company	Party Months	Ship-board Line, Kilometres	
				Aero-magnetic	Ship-board
Perth	WA-40-P	BP Petroleum Development Aust. Pty. Ltd.	0.25
"	WA-13-P	West Australian Petroleum Pty. Ltd.	504
"	WA-14-P	" " "	35
"	WA-20-P	" " "	32
Carnarvon	EP-45	Continental Oil Co. of Aust. Ltd.	2.2
"	EP-46	" " "	2.5
"	EP-47	" " "	3.5
"	EP-48	" " "	2.0
"	EP-41	West Australian Petroleum Pty. Ltd.	21
"	WA-23-P	" " "	333
"	WA-24-P	" " "	319
"	WA-25-P	" " "	2049
Canning	WA-2-P	West Australian Petroleum Pty. Ltd.	454
"	WA-21-P	" " "	615
Totals			10.45	4,362	

MAGNETOMETER

Aeromagnetic surveys were conducted in the Canning and Bremer Basins, and ship-board magnetometer in the Perth, Carnarvon and Canning Basins. Details are as follows:

MAGNETOMETER SURVEYS

Basin	Permit No.	Company	Line Kilometres	
			Aero-magnetic	Ship-board
Perth	WA-13-P	West Australian Petroleum Pty. Ltd.	504
"	WA-14-P	" " "	35
"	WA-20-P	" " "	32
"	WA-40-P	BP Petroleum Development Aust. Pty. Ltd.	107
Carnarvon	EP-41	West Australian Petroleum Pty. Ltd.	21
"	WA-23-P	" " "	333
"	WA-24-P	" " "	319
"	WA-25-P	" " "	2049

Basin	Permit No.	Company	Line Kilometres	
			Aero-magnetic	Ship-board
Canning	EP-5	West Australian Petroleum Pty. Ltd.	1228
"	EP-7	" " "	2558
"	EP-17	" " "	931
"	EP-42	" " "	7211
"	EP-44	" " "	3416
"	EP-67	" " "	1604
"	WA-2-P	" " "	454
"	WA-21-P	" " "	615
"	EP-51-52	Lennard Oil N.L.	2897
"	WA-30-P	Hematite Petroleum Pty. Ltd.	550
Bremer	WA-50-P	Esso Exploration and Production Aust. Inc.	3800
"	WA-51-P	" " "	2800
Totals			26,445	5,019

GEOLOGICAL SURVEYS

Field geological investigations were carried out by oil exploration tenement holders in the Canning and Bremer Basins. Details are as follows:

Basin	Permit No.	Company	Geologists' months
Carnarvon	EP-76	Hartogen Explorations Pty. Ltd.	3
Canning	EP-17	West Australian Petroleum Pty. Ltd.	2
"	EP-42	" " "	2
"	EP-58	Associated Australian Oilfields N.L.	2
"	EP-59	" " "	2
Bremer	WA-50-P	Esso Exploration and Production Aust. Inc.	1
"	WA-51-P	" " "	1
Total			13

GEOCHEMICAL SURVEYS

A geochemical survey was conducted over a part of the Lennard Shelf in the Canning Basin. Details are as follows:

Basin	Permit No.	Company	Field work
Canning	EP-51-52	Lennard Oil N.L.	265 samples taken over 106.5 line kilometres

PETROLEUM DEVELOPMENT AND PRODUCTION IN WESTERN AUSTRALIA IN 1972

by R. N. Cope

ABSTRACT

From the Barrow Island Oilfield a total production of 15,458,891 barrels of oil was achieved in 1972 by means of a waterflood secondary recovery scheme. Of the $199,350 \times 10^6 \text{ m}^3$ of gas produced, 9.7 per cent was used as field fuel. Installation of three compressors along the Dongara-Perth-Pinjarra gas pipeline allowed production from the Dongara and Mondarra Fields to be raised to a previously unattained level, the combined December daily average being $2,1832 \times 10^6 \text{ m}^3$. Production from Walyering No. 1 totalled $7,377 \times 10^6 \text{ m}^3$ over a period of 4 months before declining pressure enforced shut-in, and experimental production over 10 months from Gingin No. 1 totalled $40,404 \times 10^6 \text{ m}^3$.

In the northern Carnarvon Basin part of the Northwest Shelf proven and probable gas reserves have been estimated by B.O.C. as $566 \times 10^9 \text{ m}^3$ following drilling of appraisal wells in the North Rankin, Goodwyn and Angel Fields. Gas reserves of the North Rankin Field are put at $285 \times 10^9 \text{ m}^3$ by B.O.C.

INTRODUCTION

Western Australia has two petroleum fields in the course of long-term planned production, the Barrow Island Oilfield, and the Dongara Gasfield, both operated by West Australian Petroleum Pty. Ltd. (referred to here as Wapet). At Barrow Island production has again declined slightly. However, the Dongara Gasfield achieved peak production during the year. In addition, Walyering No. 1

produced gas into the Dongara-Perth-Pinjarra pipeline for 4 months. Gas produced from the prolonged production testing of Gingin No. 1 for nearly 10 months was also fed into the pipeline.

Total throughput for the Dongara-Perth-Pinjarra pipeline was $664,504 \times 10^6 \text{ m}^3$. During December the average daily throughput was $2,294 \times 10^6 \text{ m}^3$, a figure made possible by the installation of three compressors. No. 3 compressor (173.2 km from the Dongara separation and dehydration plant) was commissioned on 20th July, No. 2 (at 116.4 km) on 20th August and No. 1 (at 58.1 km) on 25th December.

Appraisal of gas pools discovered in 1971 by Burmah Oil Company of Australia Pt. Ltd. (referred to in this report as B.O.C.) took place in the northern Carnarvon Basin portion of the Northwest Shelf. Development may be confidently anticipated once substantial reserves have been proven but, owing to the large scale of an economic exploitation project and the special geographical problems involved, production seems unlikely to eventuate for some years.

Production and test flows of gas are expressed in cubic metres while liquids are expressed in barrels, both at standard conditions of 60 degrees Fahrenheit and 14.73 psia.

BARROW ISLAND OILFIELD

Since the start of production in 1967 cumulative production from the Barrow Island Oilfield has amounted to 77,463,136 barrels, of which 15,458,891 barrels were produced in 1972 (Table 8).

TABLE 8. BARROW ISLAND PRODUCTION 1972

Reservoir	Average Daily Prod. Oil (bbls) during December 1972	Production for year 1972			Cumulative Production		
		Oil (bbls)	Water (bbls)	Gas $\times 10^6 \text{ m}^3$	Oil (bbls)	Water (bbls)	Gas $\times 10^6 \text{ m}^3$
Windalia	40,652	15,185,988	5,566,788	175.911	75,267,395	11,321,642	1,334.140
Muderong	378	154,323	46,653	3.411	845,512	161,926	20.028
Jurassic 5,500'	15,580	101,628	14.620
Jurassic 6,200'	3,363	13,523	9.111	57,489	123,952	80.893
Jurassic 6,600'	58	21,094	80,423	1.201	230,389	355,763	18.072
Jurassic 6,700'	195	94,123	64,135	9.716	1,046,771	268,508	83.862
Total field	41,283	15,458,891	5,771,522	199.350	77,463,136	12,333,419	1,551.615

Water injected 1972: 41,144,564 bbls

Cumulative water injected: 139,617,839 bbls

Peak production was achieved in September, 1970 with an average of 49,803 barrels per day. During 1972 there was a further decline from an average of 43,617 barrels per day in December, 1971 to 41,283 barrels per day in December, 1972. The main reservoir is the Lower Cretaceous "Windalia Sand"

which accounted for 98 per cent of production during 1972. Owing to the very low permeability of this reservoir, achievement of a reasonable recovery factor depends on a waterflood secondary-recovery scheme (Table 9 and Fig. 14).

TABLE 9. BARROW ISLAND WELL STATUS BY RESERVOIRS AT 31ST DECEMBER, 1972

Reservoir	Flowing	Pumping	Gas Lift	Closed in	Water injection	Water Source	Water disposal	Total
Windalia	23	175	110	11	157	9	7	492
Muderong	2	3	3	8
Jurassic 5,500'	1	1
Jurassic 6,200'	2	2
Jurassic 6,600'	1	1
Jurassic 6,700'	1	1	1	2	5
Total	27	179	114	16	157	9	7	509

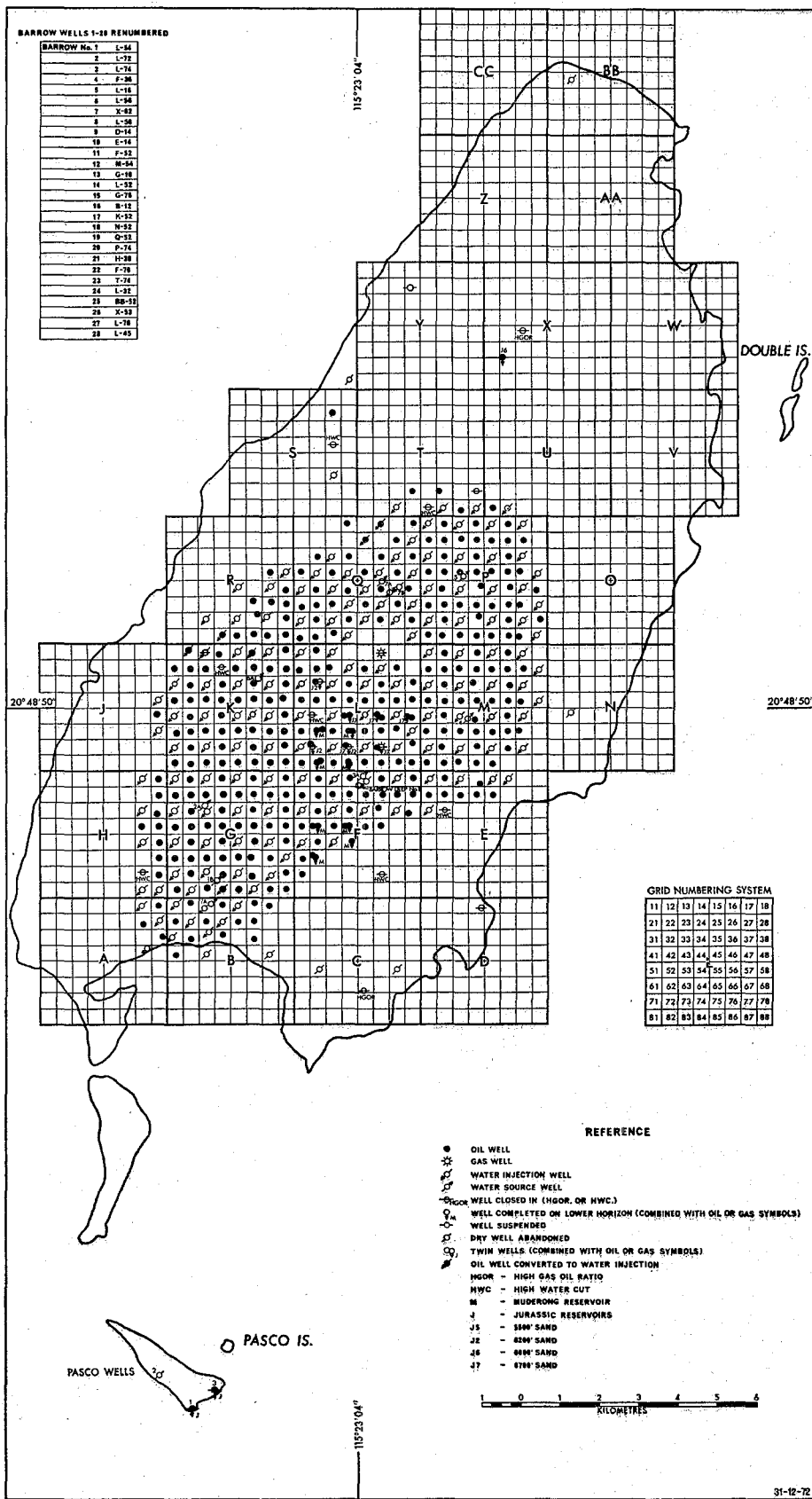

Figure 14. Barrow Island area. Windalia Reserve.

This scheme has so far operated quite successfully but it is nevertheless difficult to establish firmly the final recovery factor and therefore the ultimate reserves. A nominal initial reserves figure of 200 million barrels of oil was released at an early stage. Remaining nominal reserves at the end of 1972 were 133 million barrels. The production history of the Barrow Island Oilfield up to late 1972 has now been published (Crank, 1973).

A total of $199.350 \times 10^6 \text{ m}^3$ of gas was produced during 1972, of which 9.7 per cent was used as field fuel and the remainder flared (Table 10). A low-temperature separation plant to recover natural gasoline and liquid petroleum gas from the natural gas prior to flaring was installed, but

was operating only on an experimental basis at the end of 1972.

TABLE 10. BARROW ISLAND OIL AND GAS DISPOSAL 1972

	Oil (bbls)	Gas ($\text{m}^3 \times 10^6$)
Total production	15,458,891	199.350
Field fuel	17.110
Gas flared	182.240
Oil shipments	15,427,836
Percentage of field utilization	9.7
Percentage of gas flared	90.3
Royalty received	A\$1,452,402

NOTE: $1 \text{ m}^3 = 35.315 \text{ cu ft}$

TABLE 11. PETROLEUM PRODUCTION FROM PERTH BASIN FIELDS 1972

Field	Number of producing wells at 31/12/72	Gas ($\text{m}^3 \times 10^6$)		Condensate (bbls)		Water (bbls)	
		Total	Average daily during December	Total	Average daily during December	Total	Average daily during December
Dongara	10	571.531	1.9745	22,881	63.3	15,686	50
Mondarra	1	43.322	0.2087	6,024	29	1,508	7
Yardarino
Walpyring	7.377	1,493	1,429
Gingin	40.404	0.1051	16,912	32	10,745	30
Totals	11	662.634	2.2883	47,310	124.3	29,368	87

Total gas sold :	664.504 $\text{m}^3 \times 10^6$
Total royalties received	A\$152,472.8

On 16th September 1972, Barrow Deep No. 1 was spudded with the objective of testing the prospects of the structure between the maximum previous depth attained (2,983 m in Barrow No. 1) and 4,877 m. In December, 1972 high pressure gas was encountered at a depth of 3,239 m.

DONGARA FIELD

Details of gas and condensate production from the Dongara field are given in Table 11. Production from Dongara increased substantially during the year from an average daily production in December, 1971 of $729 \times 10^3 \text{ m}^3$ to $1.975 \times 10^6 \text{ m}^3$ in December, 1972 (Fig. 15). Three compressors were installed along the Dongara-Perth-Pinjarra pipeline to allow the increased throughput. The condensate was disposed of by road tanker to Kwinana. For the position of the Dongara Field and other Perth Basin fields refer to Cope, 1972, Figure 16.

MONDARRA FIELD

Production from the relatively small Mondarra Field, some 15 km southeast of the Dongara Field, started on 17th April, 1972. During December the average daily production was $0.2087 \times 10^6 \text{ m}^3$ of gas (Fig. 15).

WALPYRING FIELD

The discovery well, Walpyring No. 1 and an extension test well, Walpyring No. 2 were drilled in 1971. Production License No. 3 covering the Walpyring Field was issued also in that year. A further

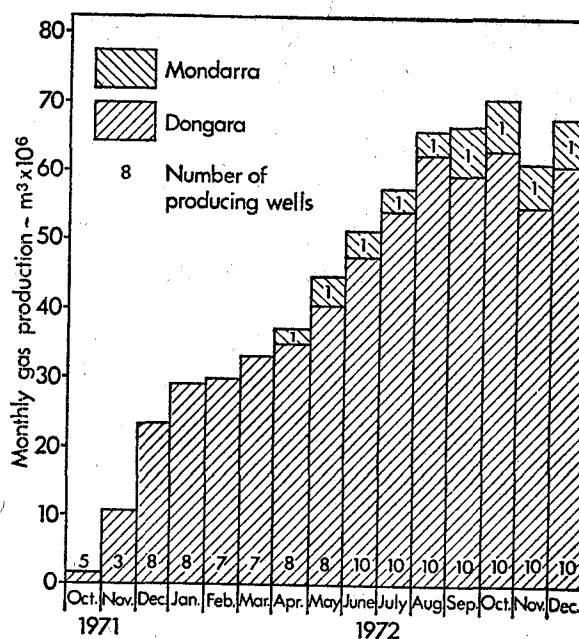

Figure 15. Monthly gas production from Dongara and Mondarra Fields 25th October, 1971 to 31st December, 1972.

extension test well (Fig. 16) was spudded, about 1.8 km southeast of Walyering No. 1, on 16th January, 1972 and reached a total depth of 4,187 m on 28th April, 1972.

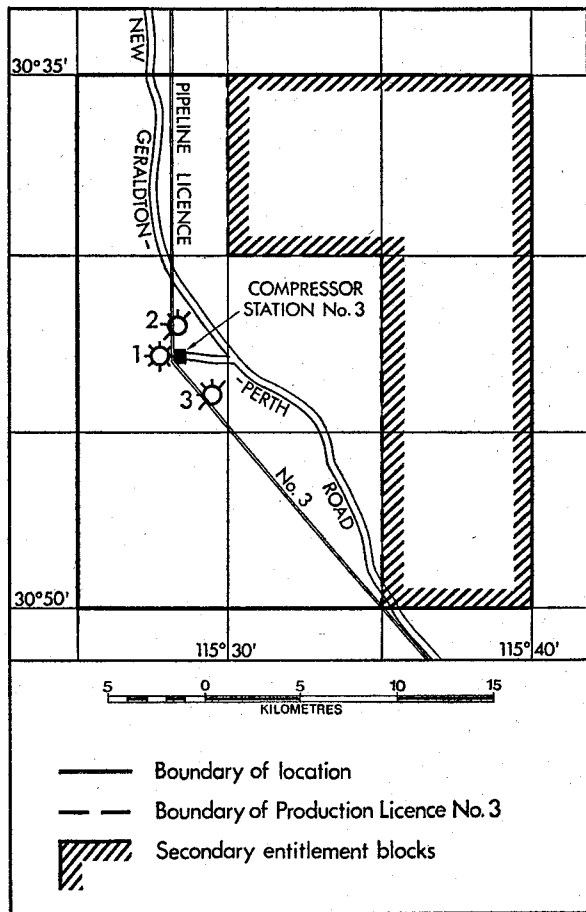

Figure 16. Production licence No. 3, Walyering Gasfield.

Gas was recorded in a number of sands but, as in the case of Walyering No. 2, testing failed to establish a commercial accumulation. Test results were as follows:

DST	Perforated interval (m)	Fluid flow
1	3,934-3,936 and 3,937-3,939	17 x 10 ³ m ³ /d gas
2	3,908-3,912	5.7 x 10 ³ m ³ /d gas
3	3,695-3,701	60 b/d water plus an amount of gas too small to measure

Under Production License 3, production of gas from Walyering No. 1 started on 23rd March. Maximum average daily production (97,047 m³) was reached in June but pressure decline led to the shutting-in of the well on 23rd July (Fig. 17). The total production from Walyering No. 1 into the Dongara-Perth-Pinjarra pipeline was 7.377 x 10⁶ m³ (Table 11).

GINGIN FIELD

Prolonged production testing of Gingin No. 1 was conducted between 6th March and 31st December, 1972 under temporary special arrangements with the State Government. The monthly production was variable as shown in Figure 17. The total production into the pipeline was 40,404 x 10⁶ m³ (Table 11).

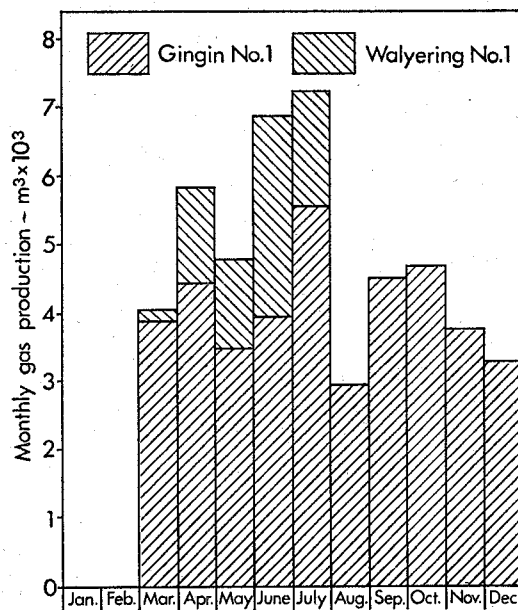

Figure 17. Monthly gas production from Walyering No. 1 and Gingin No. 1 during 1972.

NORTHWEST SHELF

GENERAL

Of the five gas discoveries made in 1971 by B.O.C. three were the subject of some degree of appraisal drilling (Fig. 18). Three wells were drilled on the North Rankin Field, one on Goodwyn and one on Angel. A further appraisal well was drilling on the Goodwyn Field at the end of the year. The discovery of heavy oil (27.6° A.P.I.) in Eaglehawk No. 1 further enhanced the prospect of the area.

In December, 1972 Woodside-Burmah Oil N. L. announced that "for the fields in the Rankin area, excluding Scott Reef, the total recoverable reserve figure in the proved, probable and possible categories of 20 trillion cubic feet could be established". This figure is equivalent to 566 x 10⁹ m³ and was put forward merely as an estimate based on rule of thumb methods.

Published information on the Northwest Shelf has recently been extended from the exploration to the appraisal stage (Martison and others, 1972). The main gas-bearing formation on the Rankin Shelf is the Upper Triassic Mungaroo Formation, while in North Rankin No. 1 a small flow of gas and a small amount of oil were recovered from the Upper Cretaceous Toolonga Calcilitite (Kaye and others, 1972). It has now been demonstrated that the crudes of the northern Carnarvon Basin may be differentiated. The Jurassic crudes (Legendre No. 1 and Barrow Jurassic) are primarily naphthenic to aromatic whilst the Barrow Cretaceous (Winalia) oil is distinctly aromatic (Powell and McKirdy, 1972).

NORTH RANKIN FIELD

The North Rankin Field covers an area of about 67 km² and lies about 120 km from the mainland. Following up the very encouraging discovery well, in which 311 m of net pay was encountered in a gross gas-bearing interval of 564 m, North Rankin No. 2 was spudded on 9th June, 1972 about 4.5 km northeast of North Rankin No. 1. It reached a total depth of 3,750 m on 1st August, 1972. Results of the four drill stem tests were as follows:

DST	Perforated Interval (m)	Choke sizes (inches)		Gas flow x 10 ³ m ³ /d	Condensate recovered b/d
		Bottom	Surface		
1a	3,168-3,197	3/8	5/8	518	517
1b	3,168-3,197	3/8	3/8	603	...
2	2,842-2,868	3/8	3/8	578	512
3	2,758-2,763	3/8	5/8	309	278
4	2,719-2,736	3/8	3/8	530	484

Together with formation interval tests, these confirmed a net hydrocarbon pay of porous and permeable sands of 383 m within a gross reservoir section of 503 m.

North Rankin No. 3 was spudded 5 km north-east of No. 2 on 4th August, 1972 and reached a total depth of 4,093 m on 14th September, 1972. Drill stem test no. 1 of the interval 3,092-3,138 m flowed 793×10^3 m³/d of gas and 796 b/d condensate on a $\frac{3}{4}$ -inch surface choke. This was followed directly by North Rankin No. 4, 2 km northwest of North Rankin No. 1, which was spudded on 30th September and reached a total depth of 4,062 m on 11th November, 1972. Testing of the interval 2,977-2,998 m resulted in a flow of 2.12×10^3 m³/d gas and 202 b/d condensate on a $\frac{3}{4}$ -inch choke.

In the December, 1972 reserve statement by B.O.C. the proved and probable recoverable gas in the North Rankin Field, assuming a recovery factor of 55 per cent, is put at 10.17 trillion cubic feet or 285×10^9 m³.

GOODWYN FIELD

Goodwyn No. 2 was spudded, in a position 4.6 km northwest of Goodwyn No. 1, on 27th March and reached a total depth of 3,750 m on 28th May, 1972. An Upper Triassic pay zone was encountered between 2,835 m and 2,892 m with 21 m of net pay. The gas/water contact is thus some 270 m higher in Goodwyn No. 2 than in Goodwyn No. 1. No drill stem tests were conducted, but formation interval tests established the condensate ratio to range between 2.54 and 3.75 barrels per thousand cubic metres, these being the highest values so far encountered in this area.

These results indicate that the Goodwyn Field is complex and that it requires much more appraisal before reserves can be confidently estimated. Goodwyn No. 3 was spudded on 16th December, 1972 in a position 5 km south-south-west of Goodwyn No. 1, and at the end of the year had reached a depth of 2,590 m.

ANGEL FIELD

The Angel No. 1 gas discovery early in 1972 was followed up by Angel No. 2 about 8 km to the northeast. This extension test well was spudded on 7th March and reached a total depth of 4,397 m on 21st May, 1972. The portion between 2,758 m and total depth is classified as an exploration hole and was subsidised under the Petroleum Search Subsidy Act. Results of drill stem testing were as follows:

DST	Perforated Interval (m) BDF	Choke sizes (Inches)		Gas Flow $\times 10^3$ m ³ /d	Condensate recovered b/d
		Bottom	Surface		
1	2,742-2,750	$\frac{3}{8}$	$\frac{3}{8}$	316	586
2	2,718-2,722	$\frac{3}{8}$	$\frac{1}{2}$	209	377
3	2,697-2,705	$\frac{3}{8}$	$\frac{3}{8}$	342	632

Further appraisal is necessary before reserves can be confidently estimated.

REFERENCES

- Cope, R. N., 1972, Petroleum development and production in Western Australia in 1971: West. Australia Geol. Survey Ann. Rept. 1971, p. 43-44.
- Crank, K. A., 1973, Geology of the Barrow Island Oilfield: Australia Petrol. Expl. Assoc. Jour., v. 13, Pt. 1.
- Kaye, P., Edmond, G. M., and Challinor, A., 1972, The Rankin Trend Northwest Shelf, Western Australia: Australia Petrol. Expl. Assoc. Jour., v. 12, Pt. 1, p. 3-8.
- Martison, N. W., McDonald, D. R., and Kaye, P., 1972, Exploration on the continental shelf of Northwest Australia: Oil and Gas, v. 19, No. 3, p. 8-18.
- Powell, T. G., and McKirdy, D. M., 1972, The geochemical characterization of Australian crude oils: Australia Petrol. Expl. Assoc. Jour., v. 12, Pt. 1, p. 125-131.

TESTS OF A PROTOTYPE 3MHZ ELECTROMAGNETIC METHOD

by N. Watanabe* and J. L. Baxter

ABSTRACT

Testing of a prototype electromagnetic method using a complex transmission frequency of 3MHz indicates that the method may be suitable for mineral exploration in Western Australia. Significant responses were obtained in traverses over hematite, oxide ores of copper, and nickel sulphides. Massive nickel sulphides were detected under a highly conductive surface layer. The equipment is capable of detecting responsive minerals to depths of 300 to 500 m. The adjustment of the prototype equipment necessary to obtain the best operating conditions proved difficult in the field. Surveying was carried out on a regional traverse at speeds of up to 65 km per hour, and satisfactory results were obtained.

INTRODUCTION

In 1971, Professor H. Kikuchi, of the Department of Electrical Engineering, College of Engineering, Nihon University, asked the Western Australian Government to co-operate in testing a new electromagnetic prospecting method. His request was approved by the West Australian Minister for Mines and a post-graduate student from Nihon University, N. Watanabe, came to Western Australia to test the equipment in September, 1972.

* Department of Engineering (Technical) Research, Post-Graduate School, Nihon University, Japan.

Twelve different sites were selected to test the method on a variety of ore minerals in areas of different climate, geology and hydrology. The results of testing of six of these areas have been selected for presentation in this report, which is condensed from a full report by Watanabe and Baxter (1972).

All of the areas investigated were held by exploration companies and, as there is a need to maintain security on some of the information presented, no localities are given.

ACKNOWLEDGEMENTS

Thanks are expressed to Mr. Fred Tanaka, Mr. Shinobu Takahashi, Misses Jo-anne Green and Sue Moulton, Mr. Neville Saunders, and Dr. Duncan Steven of the Western Australian Institute of Technology, the University of Western Australia, and the Nomura Trading Company for help in translation and interpretation. Sincere thanks are also due to the companies who provided information and target sites during the testing.

SUMMARY OF THE OPERATION OF THE EQUIPMENT

The equipment consists essentially of three oscillators (O₀, O₁ and O₂), two demodulators, and a phase meter as shown in the block diagram (Fig. 19). The standard oscillator (O₀) produces a

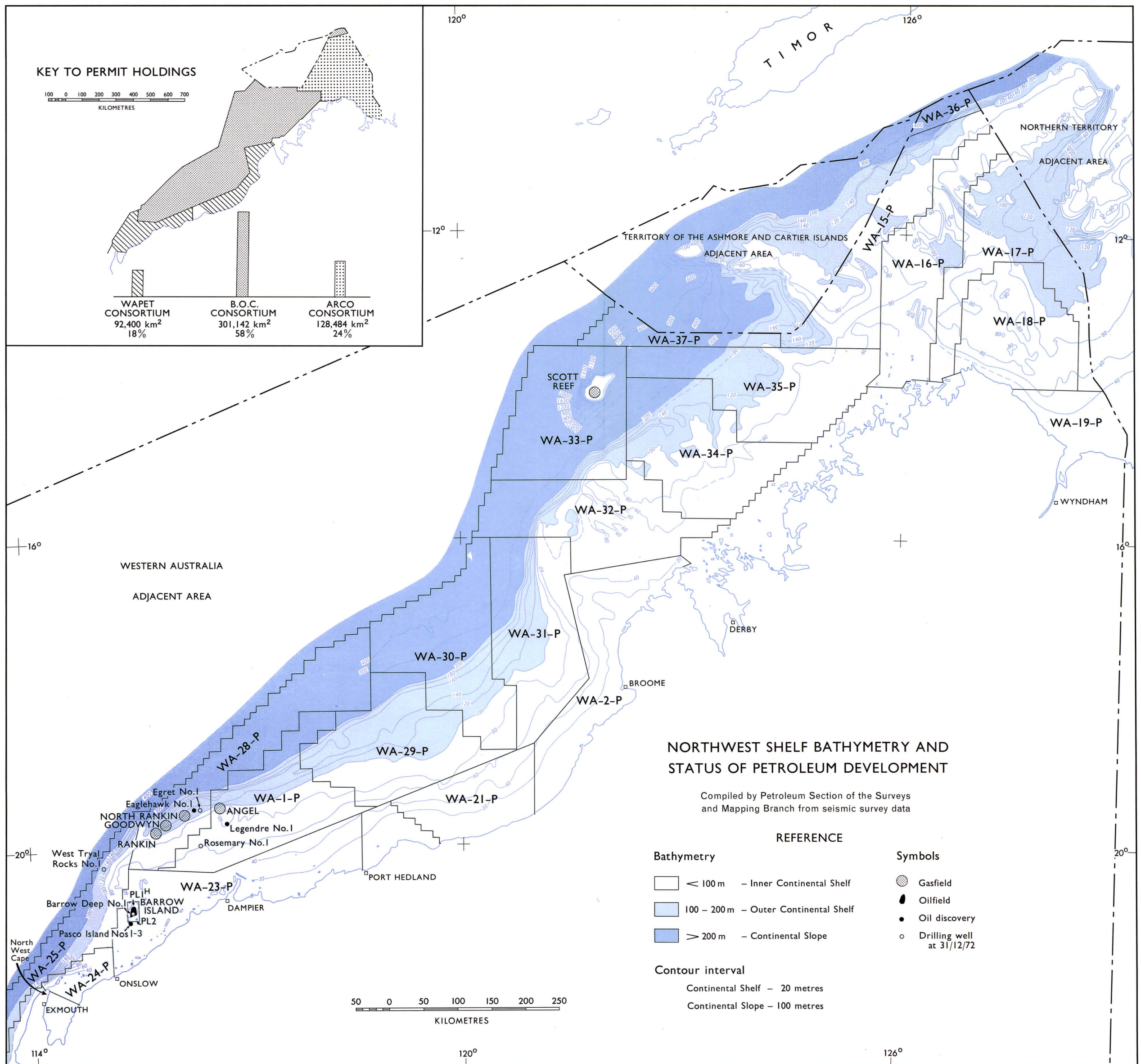

Figure 18

signal of 3MHz. The frequency difference between the two oscillators O_1 and O_2 and the standard oscillator is approximately 1KHz. It is possible to adjust the two oscillators (O_1 and O_2) to add or subtract an increment of frequency (δf).

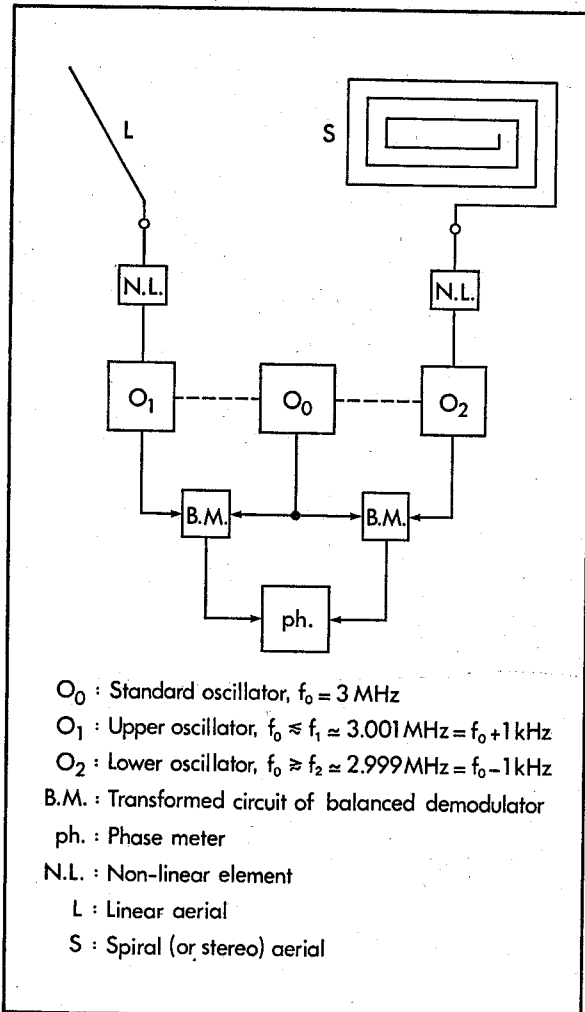

Figure 19. Block diagram of the prototype 3MHz prospecting equipment.

These two oscillators are connected to independent aerials, one of which is linear and the other is spiral as shown in Figure 19. So

$$f_1 = f_0 + 1\text{KHz} \pm \delta f_1 = 3.001 \text{ MHz} \pm \delta f_1$$

and

$$f_2 = f_0 - 1\text{KHz} \pm \delta f_2 = 2.999 \text{ MHz} \pm \delta f_2$$

where δf_1 and δf_2 can be adjusted between zero and 1KHz.

The output from the non-linear elements (Fig. 19) consists of primary beat waves of $(f_1 \pm f_0)$ and $(f_0 \pm f_2)$ and lower beats equal to $(1\text{KHz} \pm \delta f_1)$ and $(1\text{KHz} \pm \delta f_2)$. These beats are complex in nature and may include many harmonics.

The compound phase difference, P , between $(1\text{KHz} \pm \delta f_1)$ and $(1\text{KHz} \pm \delta f_2)$ is indicated by the phase meter and is approximately constant. When δf_1 and δf_2 are adjusted to the best condition for detection a very low frequency beat wave occurs and the compound phase difference, P , varies by only a small amount. This is represented on a chart record by a steady graph with small vertical movement (e.g. Fig. 22, Example 1).

Where B_f is the very low beat frequency, $(\delta f - B_f)$ has a symmetrical distribution as shown in Figure 20 and δf_0 is the value of δf when the very low beat frequency is zero. Such a condition occurs with various combinations of δf_1 and δf_2 .

These very low frequency beat waves are propagated with the complex waves formed by the transmission from the antenna. Usually when the compound phase variation (P) is small, (set by the adjustment of δf_1 and δf_2) then the equipment is operating in the optimum condition.

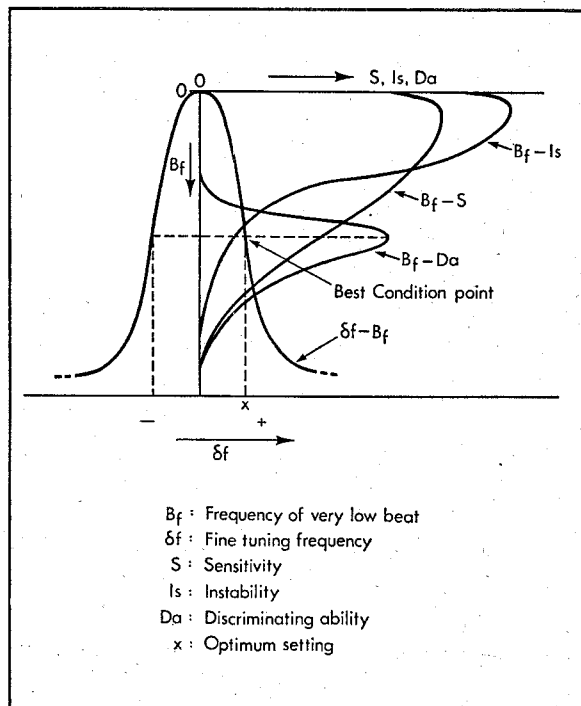

Figure 20. Optimum operating characteristics.

The propagation pattern of the transmission is shown in Figure 21. Generally the radio frequency waves are reflected at the surface or at shallow depths. As high frequency electromagnetic waves are strongly attenuated in conductive media, they rarely penetrate to a buried target. On the other hand the mixed beat wave is less attenuated and can penetrate to considerable depths, particularly as it contains very low frequency components.

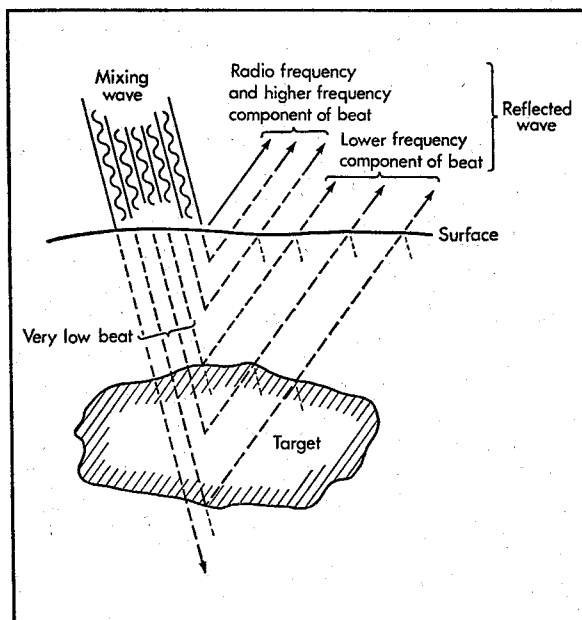

Figure 21. Propagating pattern of mixing wave.

When the beat wave is reflected from any target material it undergoes a change in phase, and the reflected wave is mixed with, and interferes with, the transmitted complex wave. The composite of the two is put into separate tank circuits on both aeri-als, and the resultant is a slightly modified, very low compound beat frequency. This compound frequency is either slightly higher, or slightly lower, than the original very low beat frequency. In the case where it is slightly higher, the phase difference is not as great as when the resultant frequency is lower than the original very low beat frequency. Thus the sensitivity increases when the very low beat frequency is modified to a lower compound frequency. The waves of high frequency and the higher harmonics are reduced with balanced demodulation and so rarely influence the compound phase difference. The phase meter measures a difference in compound phase between the two sides of the equipment, and this difference is recorded on a chart.

For effective detection the target material should contrast strongly with the host rock in the following properties: conductivity, permittivity, permeability, and density. The strongest reflection of the signal will occur when these properties are much greater in the target than in the surrounding

rock. The order of phase deviation will differ according to the composition of the target. The method can be used even if the noise level is larger than the signal level, provided that the signal level is greater than the minimum sensitivity of the equipment.

Figure 22 shows the responses expected from the equipment in normal traversing. In Example 1, where there is no anomalous material beneath the section, the width of the chart trace of the compound phase deviation is nearly constant. Inhomogeneities in the rocks may sometimes cause minor variations in the trace. Example 2 shows the expected response of a near-spherical anomalous body. In this case the response occurs immediately above the target. When the body dips, or is of an irregular shape, the type of response is as shown in Example 3, and may be offset a short distance from the true position of the body due to interference or imperfect reflection of the signal. The same response may occur if the rock texture is oblique to the anomalous body.

Discussion of the components in the equipment and the results obtained from Mount Azuma in Japan have been described by Kikuchi and others (1972).

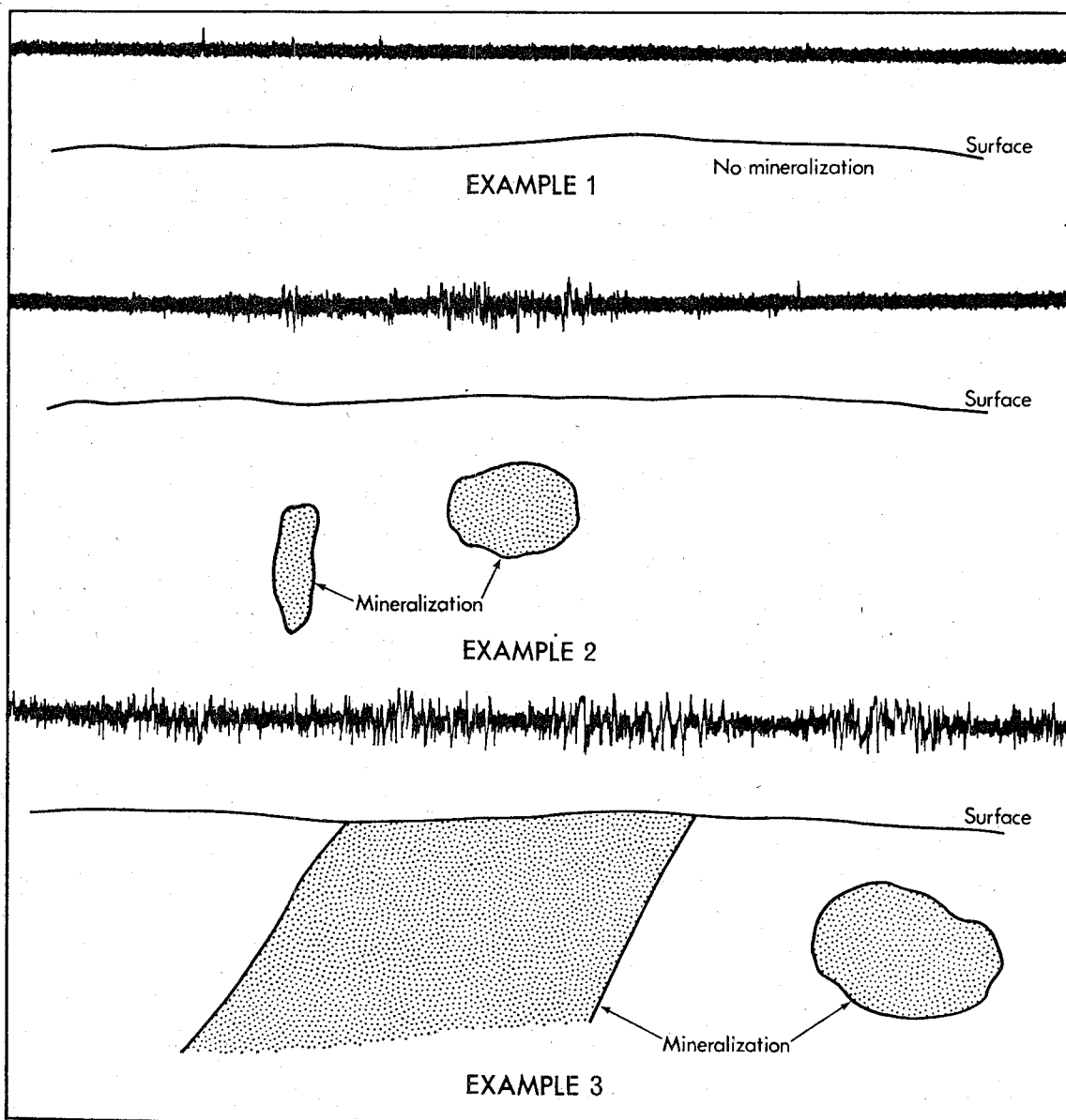

Figure 22. Examples of results.

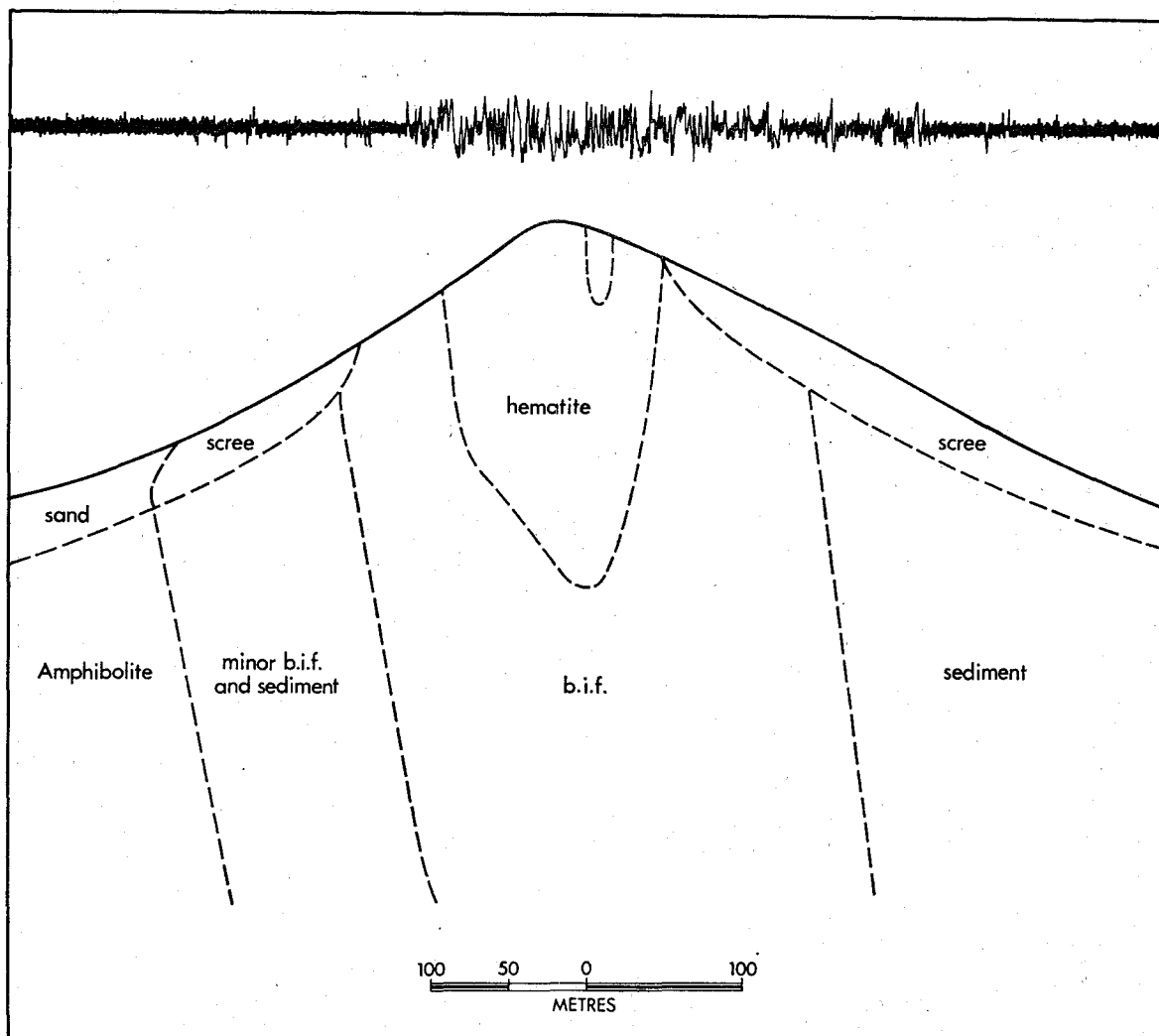

Figure 23. Area 1.

RESULTS

The following discussion of the results obtained in six of the areas tested includes a brief description of the geology of each area, but does not give all of the information that is available.

AREA 1

Geology

The traverse in Area 1 was over a sequence of steeply dipping banded iron formation with fine-grained sediments and amphibolite; hematite lenses occur within the banded iron formation. The hematite body tested is above the water table and is an enrichment of the iron formation. The mineralogy of the banded iron formation is hematite and quartz with minor magnetite and amphibole above the water table and magnetite and quartz with minor carbonate and amphibole below the water table, which is about 75 m below the highest point of the traverse. A geological section and the results of the traverse are shown in Figure 23.

Discussion of the results

The results obtained in this area show that the equipment responds to both banded iron formation and hematite. The chart presented shows the results when the equipment is set to the optimum operating conditions. Banded iron formation and hematite are distinguishable by the character of the trace and there is very little response over the sediments. The quality of this result is probably enhanced by the geological simplicity of the lode and the presence of highly magnetic minerals.

AREA 2

Geology

Area 2 consists of a sequence of flat-dipping basalt flows and gabbro sills with minor basic tuffaceous rocks. There are local concentrations of oxide ores of copper within the traversed section,

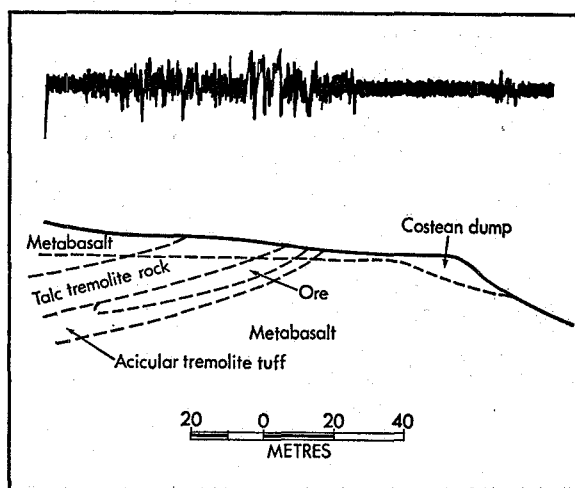

Figure 24. Area 2.

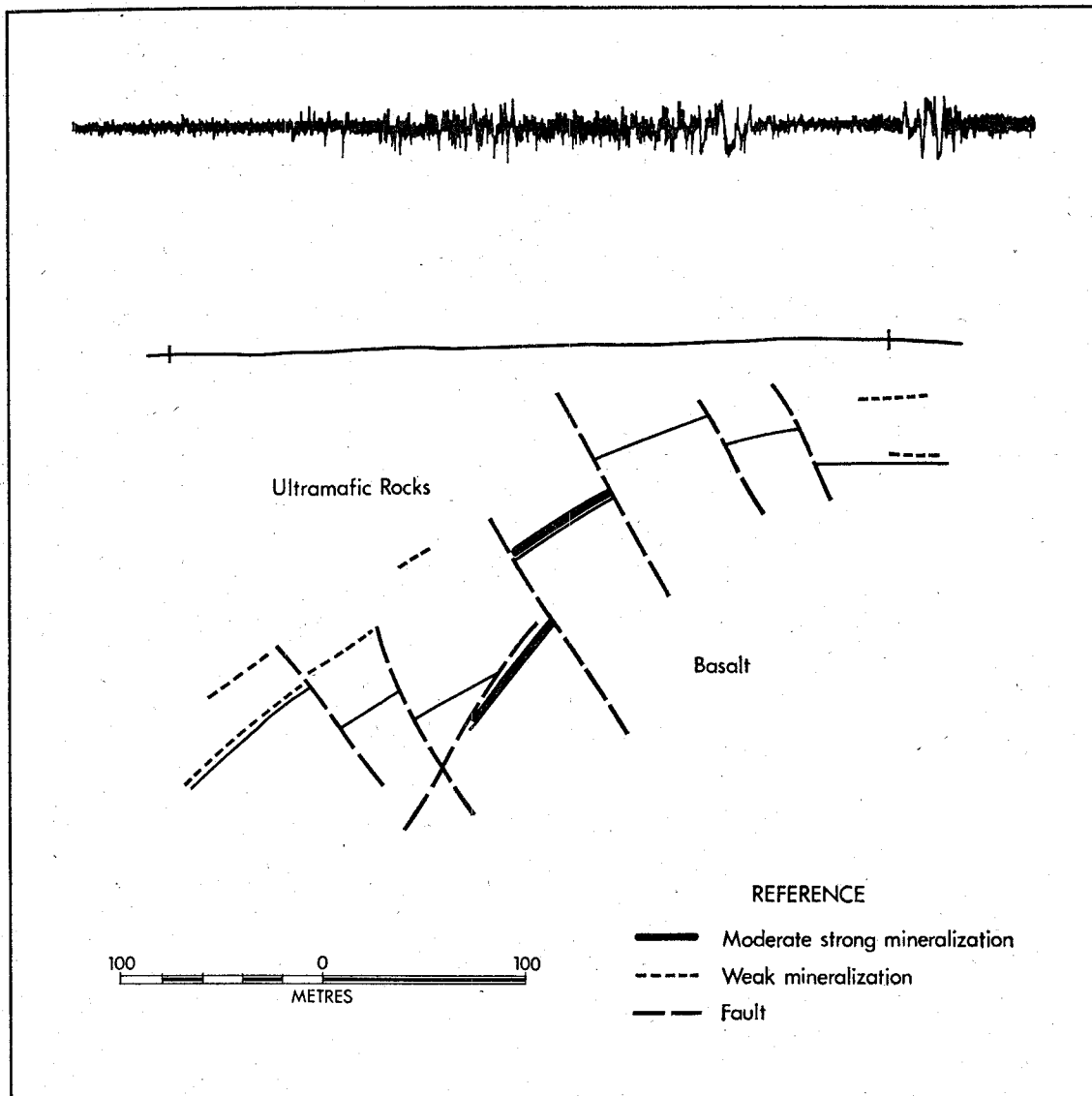

Figure 25. Area 3.

but no sulphide minerals have been reported from this deposit to date. Figure 24 shows the traverse results superimposed on the geology.

Discussion of the results

The chart indicates that the method may be able to detect oxide ores of copper. The amplitude of the trace may also indicate the presence of a deeper anomalous body, which as yet, has not been identified by other methods of prospecting. Traverses across similar geological sections in this area produced no anomalous results.

AREA 3

Geology

The host rock for the ore in Area 3 is a high-magnesian ultramafic which has been emplaced by either high-level intrusion, or extrusion. The ore consists of massive sulphides (pyrrhotite, pentlandite, chalcopyrite and pyrite) along the base of the ultramafic. There are between 1 and 10 m of highly saline, partly consolidated mud overlying weathered bed-rock in this area. The results and the geological section are presented on Figure 25.

Discussion of the results

The results obtained on this traverse show a good response over the ore body with some further reaction slightly removed from, but in the neighbourhood of the lode. The response not directly above ore zones may be related to faults. This example demonstrates that the equipment can detect anomalous bodies beneath a highly conductive layer. Effects of the latter are included in the general background noise level trace and are nearly constant.

AREA 4

Geology

A high-magnesian ultramafic rock containing massive sulphide (pentlandite, pyrrhotite, and minor chalcopyrite and pyrite) constitute the ore material in Area 4. The ultramafic has been intruded by mafic dykes and contains minor lenses of meta-sedimentary rocks. The simplified geological section and the chart from the traverse are shown on Figure 26.

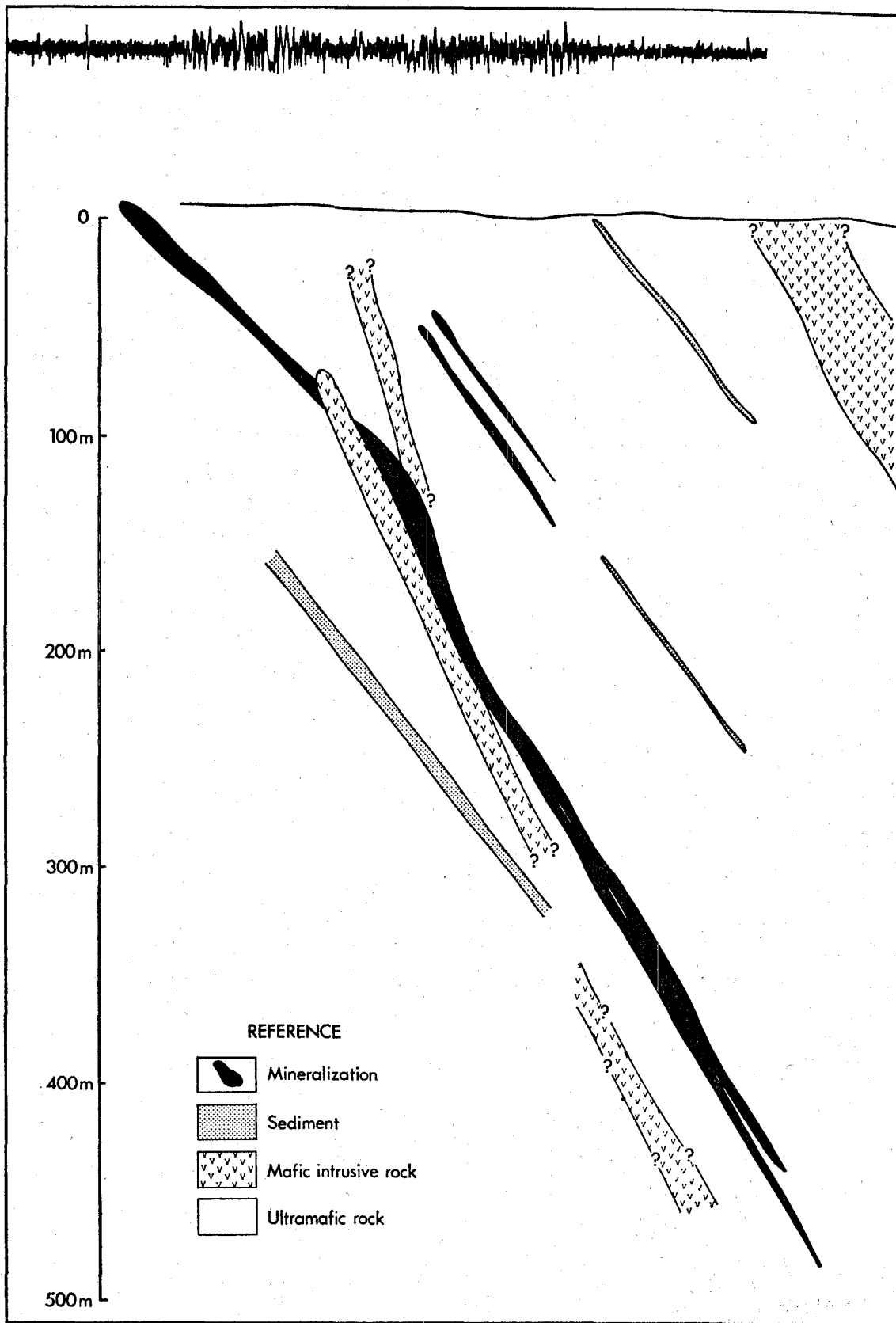

Figure 26. Area 4.

Discussion of the results

The results show the response when the instrument is adjusted to the optimum condition. The anomalies correspond well with the known distribution of ore, and indicate that detection may be

possible to a depth of 300 to 500 m. A traverse oblique to this section (Watanabe and Baxter, 1972, Area F, Traverse 2) gave poor results which are interpreted as being due to the oblique traverse over the ore body, and unstable conditions within the instrument at the time of recording.

AREA 5

Geology

The host rock in Area 5 is a serpentinized pyroxenitic ultramafic rock which has a massive sulphide zone on one side, and an associated zone of disseminated sulphide mineralization. The mineralization is pentlandite and pyrrhotite with minor chalcopyrite and pyrite. The entire zone of ultramafic rocks and mineralization is enclosed in fine-grained mafic rocks which contain minor veins of quartz with chalcopyrite and pyrite. The area is covered with between 1 and 10 m of poorly consolidated sand.

Discussion of the results

The distinct response over the ore zone corresponds well with the massive sulphides (Fig. 27). The anomalous response over the mafic rocks is probably related to the veinlets of quartz and sulphide. This traverse shows that satisfactory results can be obtained over areas where there is no exposure.

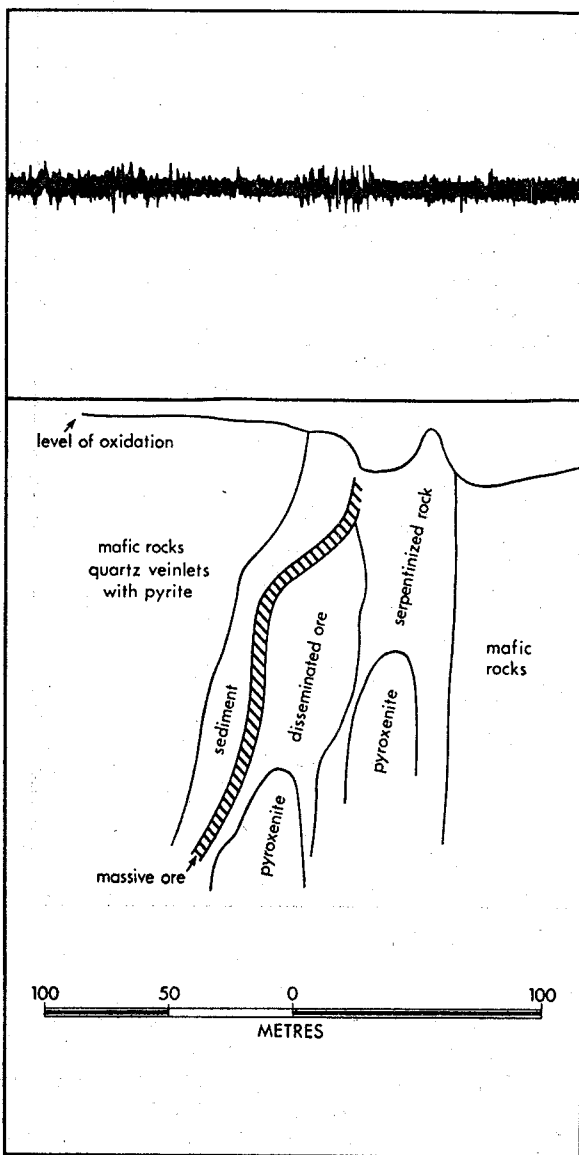

Figure 27. Area 5.

REGIONAL SURVEY

Geology

A section of the road between Scotia and Ringlock was traversed at approximately 65 km per hour to ascertain the usefulness of the method in regional geophysical reconnaissance. The results together with a map of the regional geology and the aeromagnetic contours are presented in Figure 28. West of Point A, ultramafic rocks are exposed. The remainder of the traverse has superficial rocks overlying granitic rocks to a point west of B and a succession of mafic and ultramafic rocks between C and D.

Discussion of the results

The trace obtained using this method shows that granitic rocks, mafic rocks and ultramafic rocks can be distinguished in a comparable manner to the aeromagnetic contours. It also showed that reconnaissance surveys may be carried out successfully at high vehicle speeds.

CONCLUSIONS

This prototype 3MHz electromagnetic method is easy to mount and extremely useful for rapid geophysical surveys. The results of these preliminary tests are promising and it has been demonstrated that there is a strong possibility that this method can detect hematite, oxide ores of copper, nickel sulphide, and pyrite, as well as being able to differentiate between the major rock types. The detection of disseminated molybdenite has also been demonstrated (Watanabe and Baxter, 1972).

In the current tests the entire equipment was mounted in a Landrover and surveying at speeds up to 65 km per hour gave satisfactory results. The chart used was controlled by time traversing which necessitated constant speed surveying which was difficult to maintain.

From the results obtained in Area 3 which is located on a salt lake, it is apparent that the method can obtain results through surface layers having high conductivity, where the saline layer is of fairly uniform thickness and conductivity.

The adjustment of the instrument is critical and in some areas it is difficult to obtain the optimum signal to noise ratio.

Identification of the anomalous material is difficult as the response of different lode materials is similar. Estimation of the depth of the target zone is problematical as there is no consistent relationship between depth and response in the tests. These problems may be resolved and interpretation procedures placed on a quantitative basis when the method is more fully investigated.

It is possible to identify lode zones where there are separate bodies of anomalous material. This is seen in Area 4 where there is an increase in the signal strength over the subsidiary ore horizons, as well as the normal signal over the main ore horizon.

The method may prove to be of considerable value for detecting mineralized zones when they are completely covered by overburden, as in Area 5.

REFERENCES

- Kikuchi, H., Nakjima, Y., Watanabe, N., Yashiro, N., and Sugiura, Y., 1972, Subu-earth prospecting-V. Improvement of the prospecting device and prospecting in Mount Azuma: Nihon University, College of Engineering, Bull. 13-A (In Japanese).
- Watanabe, N., and Baxter, J. L., 1972, Tests of a prototype 3MHz electromagnetic method in Western Australia, 1972: West. Australia Geol. Survey Rec. 1972/23 (unpublished).

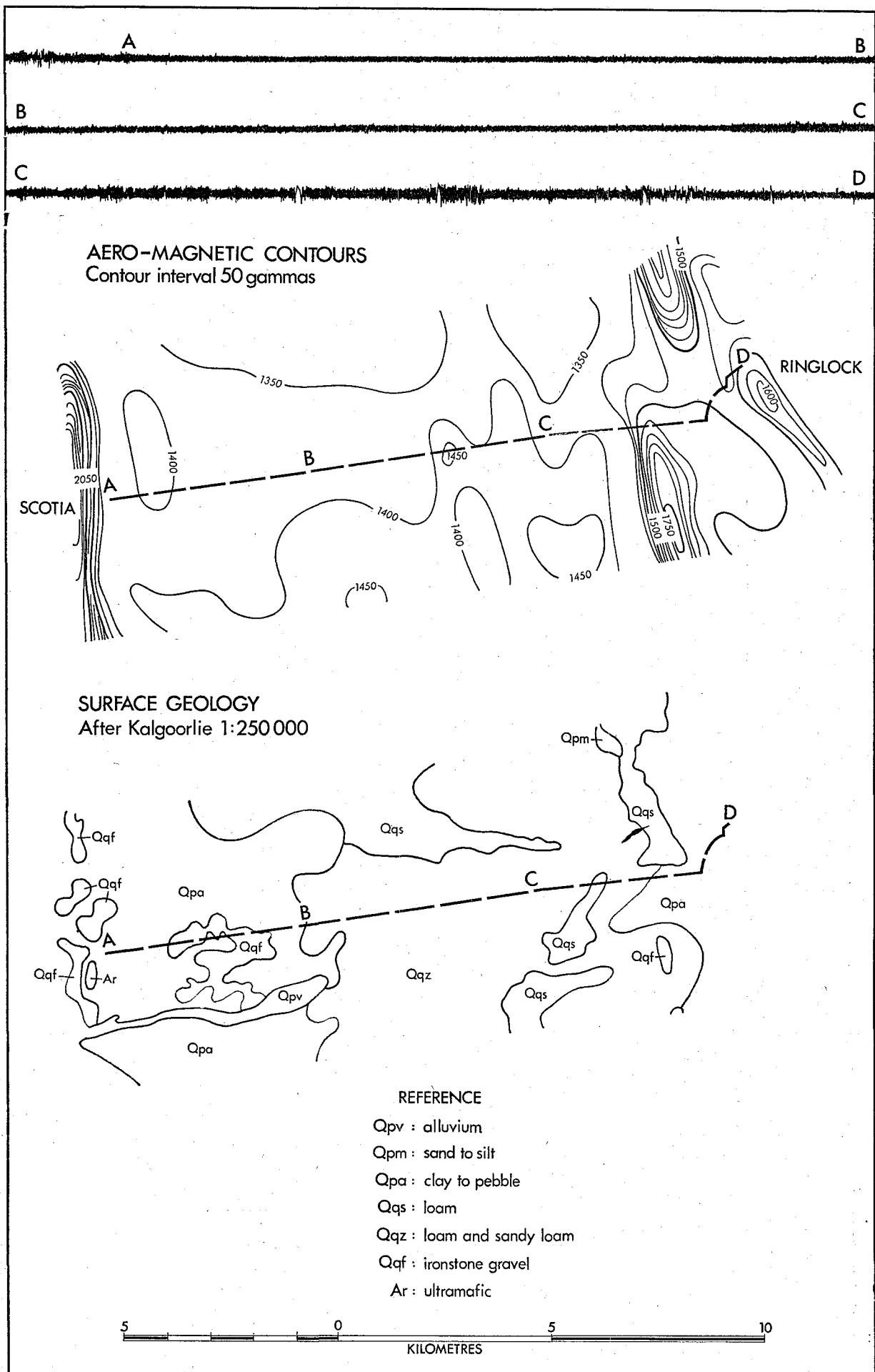

Figure 28. Regional survey.

SILICA-RICH PILLOW LAVAS NEAR SOANSVILLE, MARBLE BAR 1:250,000 SHEET

by S. L. Lipple

ABSTRACT

Excellent exposures of undeformed silica-rich pillow lavas were found during regional mapping of the Marble Bar 1:250,000 sheet. These closely resembled the form of basaltic pillow lavas abundant elsewhere on the sheet, but were notably hard and of siliceous appearance, with only weak carbonation. Analyses of major oxides and some trace elements are presented for two samples. These are compared with average analyses taken from the literature and, together with petrography of the samples, suggest that the pillow lavas are of rhyodacitic composition.

INTRODUCTION

During regional mapping of the Marble Bar 1:250,000 sheet (Hickman and Lipple, in prep.), silica-rich pillowed lavas and pyroclastics were found in a succession of Archaean basaltic volcanics, chert and ultramafic rocks. The pillowed lavas and agglomerates are excellently exposed in a gorge east of Soansville at lat. $21^{\circ} 31' 32.3''$ S and long. $119^{\circ} 12' 55.7''$ E along a tributary of Dalton Creek. The silica-rich pillow lavas are distinct from carbonated pillowed basalt lavas elsewhere in the area of the Marble Bar 1:250,000 sheet, for example those 2.5 km northwest of the Marble Bar Pool. Carbonated basaltic pillow lavas

are mentioned by Noldart and Wyatt (1962), p. 109-112, and described by Finucane (1936) p.3. In the field, the pillows were noted to be light coloured, siliceous and apparently feldspathic, and were considered to be of possible rhyolitic or dacitic composition. However, subsequent studies did not clearly support this conclusion, and for the purposes of the following discussion, the pillows are described as being silica-rich or felsic. Pillow lavas of similar composition are not known to have been recorded from any other locality in Western Australia. Field mapping has suggested the existence of at least three other occurrences of similar pillow lavas, one occurrence 18 km northeast of Abydos at lat $21^{\circ} 17' 39.4''$ S and long. $119^{\circ} 1' 31''$ E, another 1.5 km southeast of Kelly's Copper mine at lat $21^{\circ} 48' 24.5''$ S and long $119^{\circ} 52' 53.4''$ E, and at $21^{\circ} 55' 15.5''$ S and long. $119^{\circ} 43' 45.2''$ E. However, these have not been further investigated.

GEOLOGY

GEOLOGICAL SETTING

The regional geological succession is shown in Figure 29. It consists of Archaean basaltic volcanics, partly pillow lavas, chert, rhyolitic volcanics and intrusive ultramafic rocks. The succession is folded and metamorphosed, generally to greenschist facies, but in part to amphibolite facies, and intruded by well foliated granitic rocks to the east.

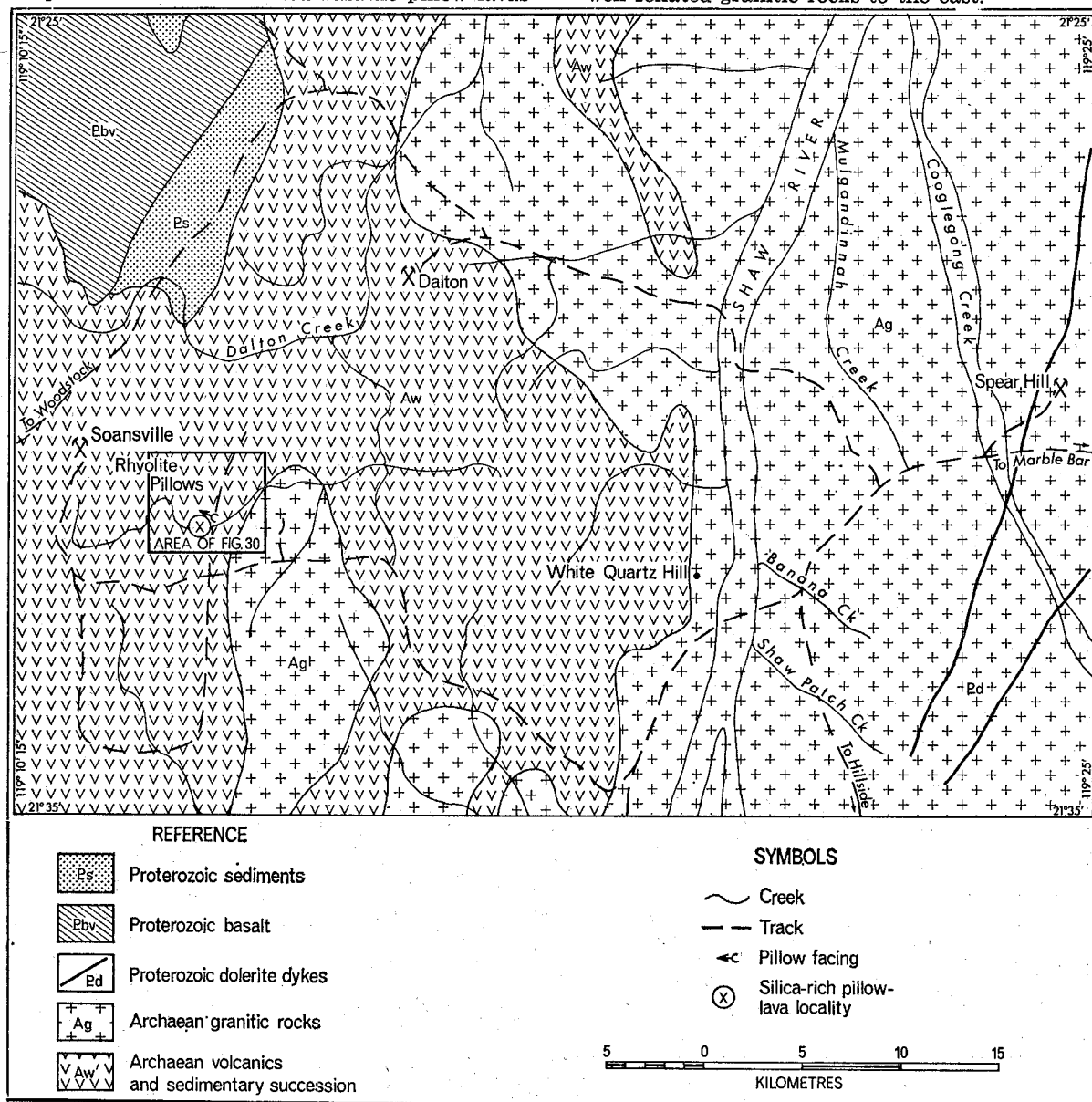

Figure 29. Locality map of pillow lavas showing regional geology.

The rocks immediately surrounding the felsic pillow lavas are shown in Figure 30. Approximate thicknesses of each unit as measured along AB in Figure 30 are shown in Table 12. The succession

strikes at 030°, dips vertically or steeply west, and faces westwards, as determined by well preserved pillow structures.

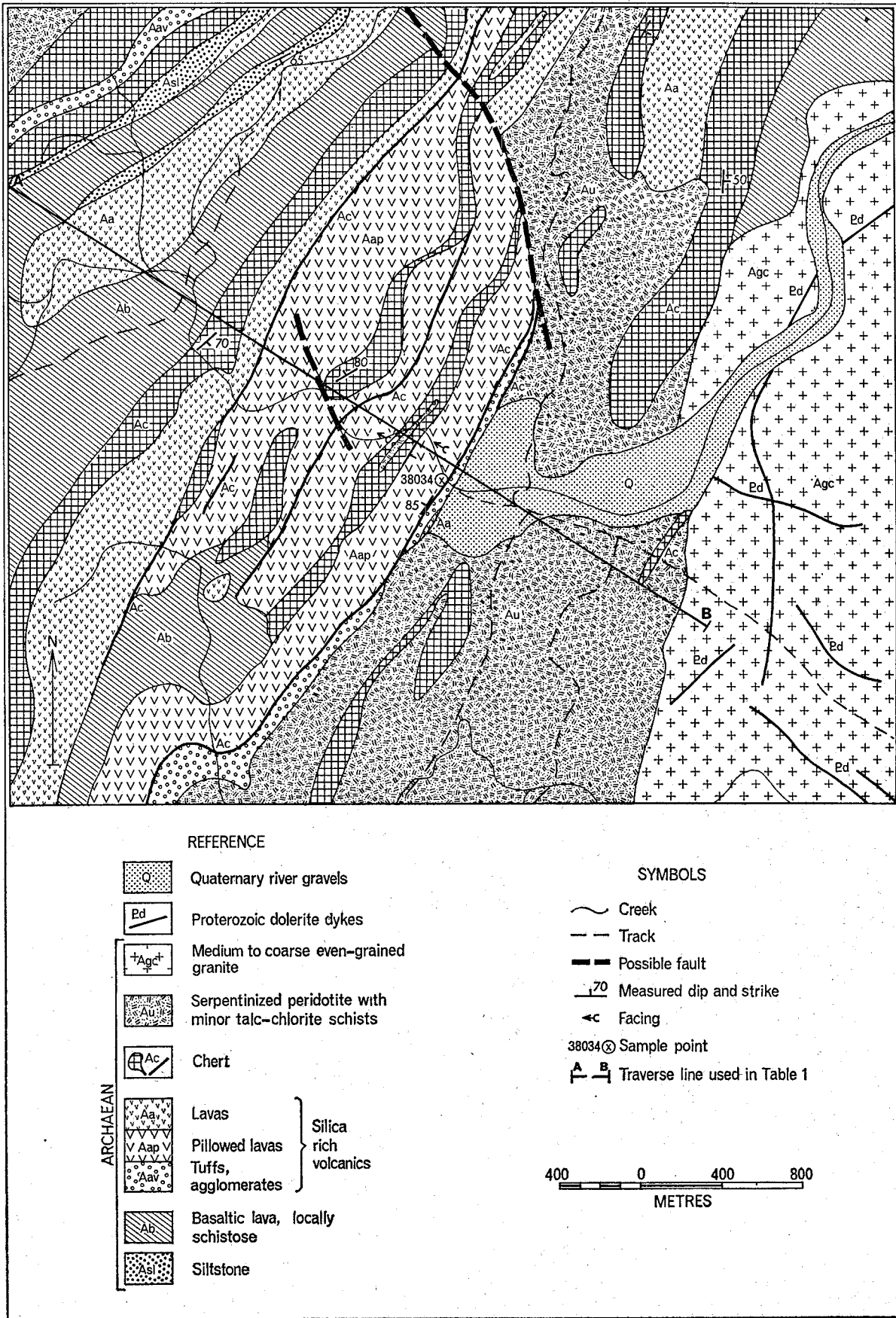

Figure 30. Detailed geological map of the area surrounding the pillow lavas.

TABLE 12. GEOLOGICAL SETTING

Map Symbol on Fig. 30	Approximate thickness metres	Description
Ab	Basalt
Aa	270	Silica-rich volcanics
Ab	235	Basalt, weakly schistose, fine to medium-grained, massive to weakly vesicular
Acf	140	Chert, dark-coloured, well folded
Aap	67	Silica-rich pillow lavas
Acw	5	Chert, black-coloured, massive
Aap	237	Silica-rich pillow lavas
Acw	80	Chert, dark-coloured
Aap	65	Silica-rich pillowed lavas
Acw	5	Chert, black to dark grey-coloured
Aap	118	Silica-rich pillowed lavas
Acw	2	Chert, banded grey and white-coloured
Aut	5	Ultramafic, fine-grained, soft, dark green-coloured talc-chlorite rock
Acw	3	Chert, dark, massive, vertically dipping
Aap	135	Silica-rich pillow lavas. Specimens 38034C and D
Acw	4	Chert, light grey-coloured, western margin well banded
Aav	1	Waterlain tuff, well bedded, laminated bedding, cross-bedding and possible ripple structures
Aav	30	Silica-rich agglomerate, rounded to angular vesicular rhyolite boulders in a siliceous matrix, possibly felsic glass
Aa	10	Massive grey-coloured rhyolitic lavas
Aav	5	Weathered, purple-coloured, quartz-bearing tuffs felsic
Aup	135	Ultramafic as below
Acw	20	Chert, lenticular
Aup	417	Ultramafic, as below. In part weathered to light green serpentinite pseudomorphing original peridotite texture
Acw	10	Chert, massive, lenticular recrystallized, dark grey-coloured, intruded by ultramafic
Aup	135	Ultramafic, dark-coloured serpentinite pseudomorphing fine to medium-grained olivine-rich peridotite with close-packed, granular olivines set in a pyroxene matrix
Age		Medium to coarse even-grained biotite adamellite

The lowest layer of pillows, overlying a thin banded grey chert, has flat basal margins and convex upper surfaces (Fig. 31, B), also indicating a westward facing. Below the chert 30 m of agglomerate contains rounded to angular, fine-grained, grey-coloured, vesicular, rhyolitic fragments in a siliceous, tuffaceous (or ?glassy) matrix. The upper metre of this unit consists of well bedded, cross-bedded (west-facing) waterlain tuff. Although some fragments have sizes up to 1 x 2 cm, most are generally coarse sand sized in a finer matrix. Lamination is formed by grain-size variation. Some bands show probable ripple marking.

Below the agglomerate unit, 10 m of massive silica-rich lavas overlie at least several metres of weathered purple-coloured tuffs containing abundant quartz fragments.

DESCRIPTION OF THE PILLOWS

As shown in Figure 31, A, the pillows are well exposed and have well formed pillow structures with convex upper surfaces and concave basal margins, often with drape structures including tails. Facing determined from these structures is consistently westward. On the side of the gorge in which the pillows are exposed, they form prominent bulbous protrusions. The pillows are of variable size, frequently large, up to 4 m long and 1 m thick, but generally about 1 m long and 50 cm thick. The pillows have minor chalcedony veins.

The pillow margins are very fine grained, abundantly vesicular to amygdaloidal (Fig. 31, B-D) and are light greenish-grey. The inner portions of the pillows are medium grey, fine grained, and contain chalcedony-filled vesicles elongated radially to the chilled margins. The rock is fresh and so hard that the surface cannot be scratched with a hammer. Hand specimens show only weak reaction with dilute hydrochloric acid, indicating some carbonate along thin veins but little to none within the groundmass. Colour variations within the pillow appear to correspond to areas of alteration seen in thin section. Minor pyrite is present.

The interpillow material (Fig. 31, C, D) is a mixture of massive grey chert and felsic tuff. The chert is thought to have been injected into the interstitial positions as the still plastic pillows burrowed down through poorly consolidated chert onto a consolidated pillow layer below. Some chert may have been precipitated simultaneously with the accumulation of pillows from silica-charged seawater.

Local brecciation of pillows occurs adjacent to a pod of massive grey chert. This hyaloclastite grades rapidly into unbroken pillows. There are minor layers of massive lava. All the pillows observed were non-variolitic. The possibility that the pillowform structures were actually spheroids developed in subaerial felsic lava is discounted by the presence of well formed drape features or tails in the pillows, which together with convex tops give consistent facing. Chilled vesicular margins, and a flat bottomed basal layer of pillows adjacent to banded chert also indicate a pillow, rather than a spheroid origin.

PETROGRAPHY OF THE PILLOWS

In thin section, the pillow lavas exhibit well preserved microporphyrritic, hyalopilitic, amygdaloidal and spherulitic textures. Numerous rounded to irregular and elongate vesicles were infilled with a very fine-grained mosaic of chalcedony around the margins grading inward into polygonal masses of radiating fibrous fans of chalcedony. Some vesicles contain small cores of coarser anhedral quartz, and others consist entirely of a fine, massive mosaic of chalcedony.

Microporphyritic texture in the rock is exhibited by microphenocrysts of euhedral to subhedral plagioclase, in part sericitized, set either singly or in clusters in a brown coloured groundmass of crystallites which are in turn set in a nearly cryptocrystalline matrix (Fig. 32, A). The plagioclase is too fine for convenient optical determination, but X-ray diffraction examination of material from 38034D shows the presence of sodic plagioclase, possibly oligoclase. Rare patches of a fine-grained mosaic of feldspar embayed by chlorite have a euhedral outline and may pseudomorph calcic plagioclase microphenocrysts.

The groundmass consists of elongate feldspar crystallites (0.25 mm long) forming a relict hyalopilitic texture with an almost cryptocrystalline interstitial matrix (Fig. 32, D), which is thought to result from devitrification of glass. Near some vesicles, the crystallites appear to be moderately flow aligned. At higher magnification, the interstitial material is seen to consist of a very fine-grained mosaic of feldspar and quartz, and to contain small anhedral granules of leucoxene.

Portions of the cryptocrystalline matrix appear to have been devitrified from glass, forming numerous well developed microlites locally joined together in bow-tie manner to form spherulitic

FIGURE 31 (opposite)
Photographs of felsic pillow lavas

- West-facing pillows showing convex tops and tail structures.
- Small pillow in basal layer of pillow lavas overlying banded and partially mobilized chert.
- Amygdaloidal, chilled, light coloured pillow margins. Some dark interpillow chert and tuff.
- Amygdales elongate to pillow margins. Chalcedony veins intruding the pillows. Dark tuffaceous, cherty interpillow matrix.



B



D

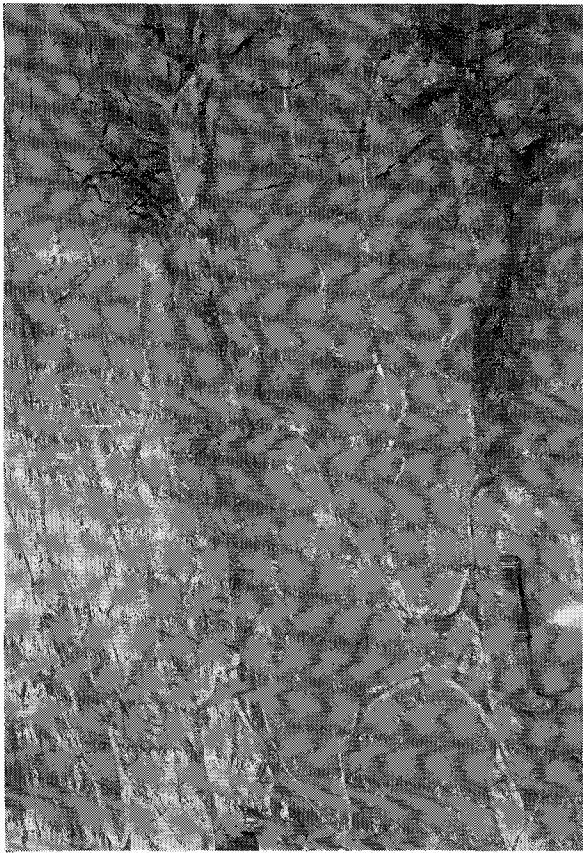

A

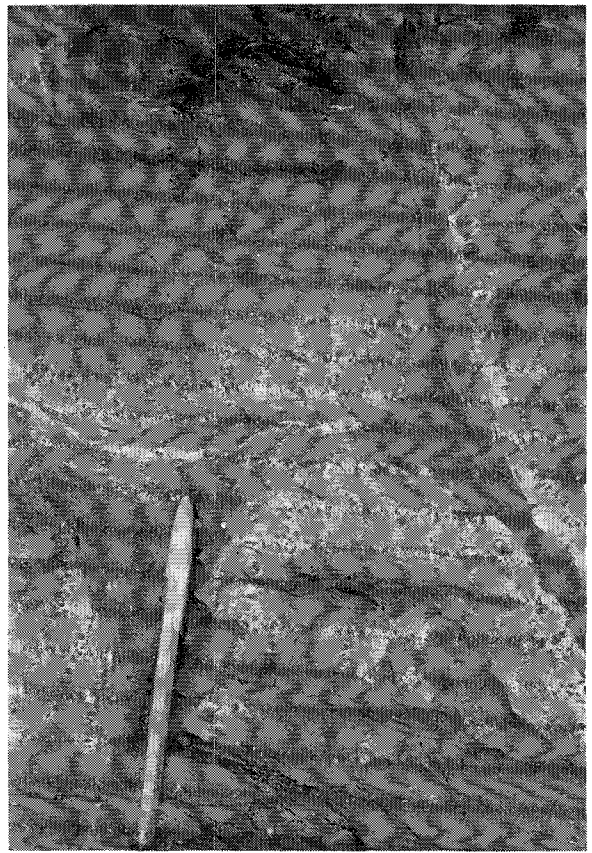

C

Figure 31

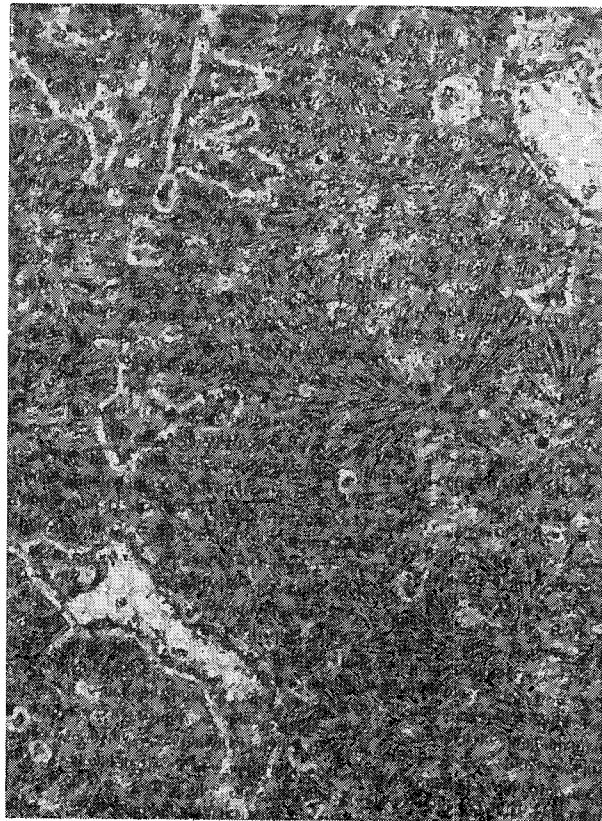

B 0.5 mm

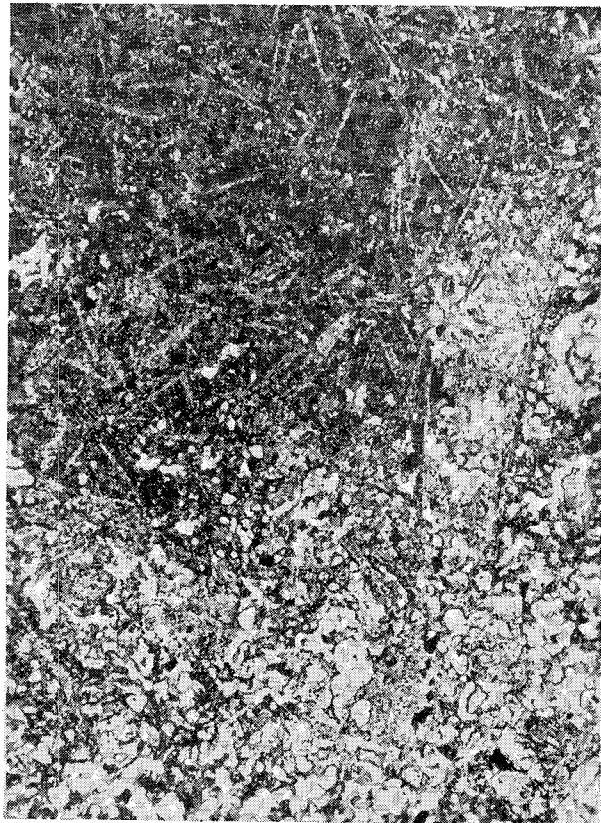

D 0.5 mm

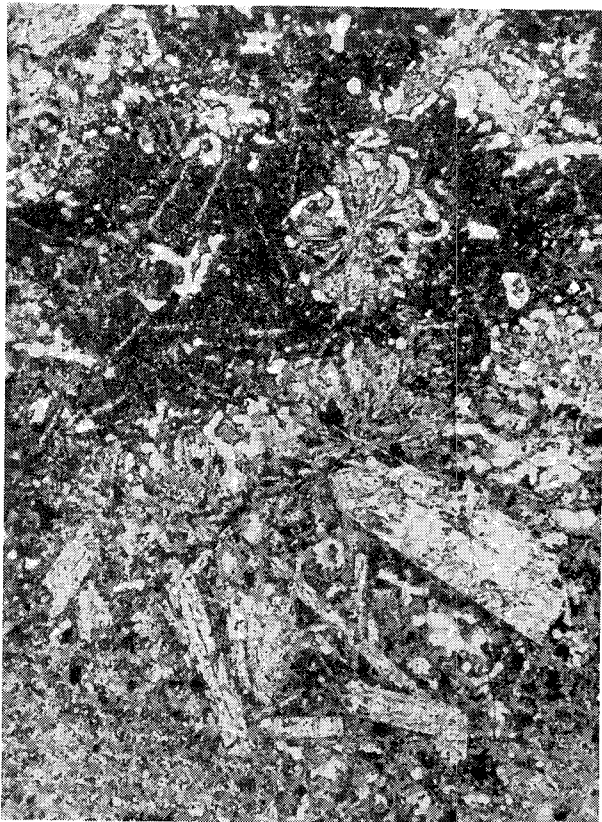

A 0.5 mm

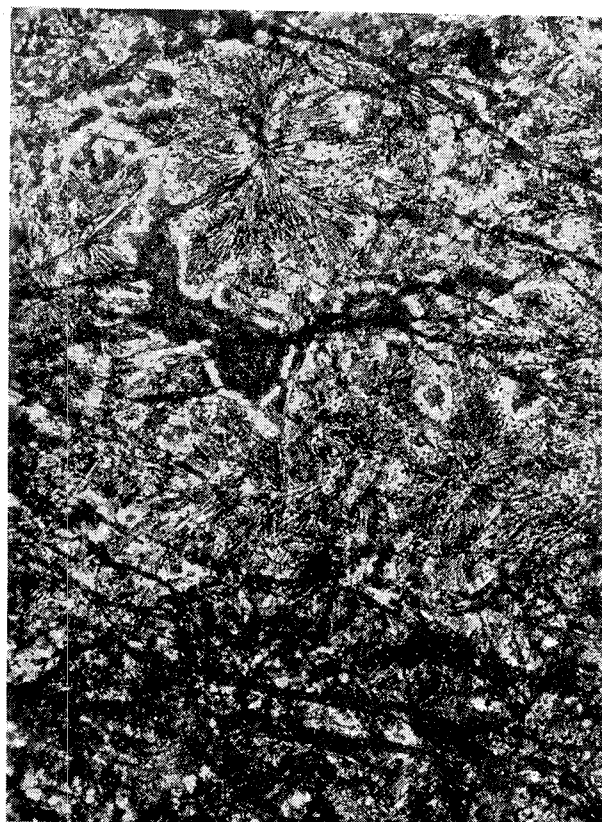

C 0.5 mm

Figure 32

FIGURE 32 (opposite)

- Photomicrographs of felsic pillow lavas in plain polarized light
- A Plagioclase phenocrysts and crystallites.
 - B Chalcedony-filled amygdalae and spherulitic texture.
 - C Spherulitic structure with interstitial cryptocrystalline material.
 - D Crystallites (right) and prehnite alteration (white patches on left).

masses (Fig. 32, B, C). The microlites consist of thin, elongate, curved needles. Between the microlite bundles are small irregular patches with margins of clear mosaic quartz and central areas of fine-grained, massive, felted or fibrous actinolite, probably also after glass (Fig. 32, B). The spherulitic content is variable. Both microlites and spherulites are composed of colourless feldspar. Some microlites are skeletal with numerous short projections of apparently similar composition growing orthogonally from the margins into the matrix.

Accessory minerals include abundant leucoxene and sphene, and minor magnetite. Some cubic iron sulphide, bronze coloured in reflected light, occurs within the larger chalcedony veins. Since no exsolution was observed, the mineral is probably pyrite. Although sulphide observed in hand specimens apparently occurred in the groundmass, its occurrence in the four thin sections examined was restricted to chalcedony veins.

The thin sections contain several veins which penetrate and embay the rock, and consist of massive or fan-shaped chalcedony with central lenses of anhedral granular unstrained quartz in part. These veins are truncated and offset by later calcite veins which sometimes include prehnite and chlorite. Some of the chalcedony veins terminate at vesicles.

The degree of alteration is variable. Some plagioclase microphenocrysts are colourless and

unaltered, while others are partially replaced by prehnite and/or sericite and rarely by calcite. Possible relics of calcic plagioclase microphenocrysts are embayed by chlorite. Part of the glassy area has originally been replaced by chlorite which appears to have altered to fine fibrous actinolite. An apparently subhedral area of chlorite resembles a pseudomorph of poikilitic (feldspar inclusions) mafic microphenocryst.

Moderate amounts of secondary prehnite (Fig. 32, D) embay the groundmass, and clusters of apparently separate granules show simultaneous extinction. Prehnite alteration corresponds to colour variations seen on a polished hand specimen surface, and is greater towards the margins of the pillows. Vesicle infillings of fine-grained, massive mosaic chalcedony show minor replacement by calcite, and chalcedony veins have minor vermicular replacement by prehnite.

The probable alteration history was broadly: devitrification of glass and formation of spherulites; development of sericite, chlorite and conversion of ilmenite to leucoxene and possibly sphene; formation of chalcedony veins; and subsequent development of calcite, prehnite and actinolite.

The abundance of feldspar microphenocrysts, crystallites and microlites, cryptocrystalline feldspar-quartz matrix, and paucity of mafic minerals supports field observations that the pillow lavas are of felsic composition.

CHEMICAL COMPOSITION

Two fresh samples, 38034C and D, from the same silica-rich pillow were chemically analysed for major oxides (Table 13) and trace elements (Table 13B). The samples were collected 4 and 7 cm from the pillow margins, respectively. Columns 1 and 2 of Table 13 list the original analyses of 38034C and D. Column 3 is the mean of the two analyses.

TABLE 13. CHEMICAL COMPOSITIONS OF SILICA-RICH PILLOW LAVAS AND COMPARISON WITH PUBLISHED AVERAGES OF RHYOLITE, DACITE, ANDESITE AND BASALT

Major Oxide (%)	38034C	38034D	Mean						Rhyolite	Calc-Alkali Rhyolite	Alkali Rhyolite	Dacite	Rhyodacite	Dacite	Andesite	Tholeiitic Basalt
	1	2	3	4	5	6	7	8	9	10	11	12	13	14	15	16
SiO ₂	67.7	71.0	69.4	68.7	69.8	71.4	54.2	50.8	73.43	73.66	74.57	64.27	66.27	63.58	54.20	50.83
Al ₂ O ₃	12.9	12.9	12.9	13.2	13.4	13.7	20.4	21.9	13.54	13.45	12.58	16.87	15.39	16.67	17.17	14.07
Fe ₂ O ₃	1.1	0.3	0.7	0.7	0.7	0.7	1.1	1.2	1.01	1.25	1.30	3.13	2.14	2.24	3.48	2.28
FeO*	5.36	1.88	3.62	3.69	3.75	3.83	5.73	6.15	0.36	0.75	1.02	2.01	2.23	3.00	5.49	9.00
MgO	2.6	0.9	1.8	1.8	1.8	1.9	2.8	3.0	0.26	0.32	0.11	1.85	1.57	2.12	4.36	6.34
CaO	3.06	4.46	3.76	3.84	3.90	3.99	5.95	6.39	0.77	1.13	0.61	4.63	3.68	5.53	7.92	10.42
Na ₂ O	0.11	3.36	1.74	1.78	1.81	1.85	2.75	2.96	2.25	2.99	4.13	3.97	4.13	3.98	3.67	2.23
K ₂ O	2.3	1.2	1.8	1.8	1.8	1.9	2.8	3.0	6.45	5.35	4.73	1.68	3.01	1.40	1.11	0.82
H ₂ O+*	2.89	0.99	1.94	1.98	2.01	3.07	3.30	1.52	0.78	0.66	1.20	0.68	0.56	0.86	0.91
H ₂ O*	0.19	0.11	0.15	0.15	0.16
CO ₂ *	1.53	2.16	1.85	1.89	0.01
TiO ₂	0.54	0.54	0.54	0.55	0.56	0.57	0.85	0.92	0.10	0.22	0.17	0.38	0.66	0.64	1.31	2.03
P ₂ O ₅	0.03	0.06	0.05	0.05	0.05	0.05	0.08	0.09	0.02	0.07	0.07	0.08	0.17	0.17	0.23	0.23
MnO	0.28	0.11	0.20	0.20	0.21	0.21	0.32	0.34	0.02	0.03	0.05	0.06	0.07	0.11	0.15	0.18
Totals	100.6	100.0	100.5	100.3	100.0	100.0	100.0	100.0	100.05†	100.0	100.0	100.20‡	100.0	100.0	100.0	100.0

KEY TO COLUMNS :

1. Original analysis of 38034C
 2. Original analysis of 38034D
 3. Mean of (1) and (2)
 4. (3) recalculated to remove 2 per cent chalcedony veining
 5. (4) recalculated to 100.0 per cent, removing CO₂
 6. (4) recalculated to 100.0 per cent, removing CO₂, H₂O+ and H₂O—
 7. (4) recalculated to 100.0 per cent, removing CO₂ and H₂O—, and removing 15.2 per cent SiO₂ to simulate an average andesite
 8. (4) recalculated to 100.0 per cent, removing CO₂ and H₂O—, and removing 18.5 per cent SiO₂ to simulate an average basalt
 9. Average of 26 rhyolites from Johannsen, 1932, p. 265, Table 132
 10. Average of 22 calc-alkali rhyolites and rhyolite-obsidians from Nockolds, 1954, p. 1012, Table 1, Column II
 11. Average of 21 alkali rhyolites and rhyolite-obsidians, *ibid.*, Column IV
 12. Average of 19 dacites from Johannsen, 1932, p. 398, Table 197a
 13. Average of 115 rhyodacites and rhyodacite-obsidians from Nockolds, 1954, p. 1014-1015, Table 2, Column IV
 14. Average of 50 dacites, *ibid.*, Column VI
 15. Average of 49 andesites, *ibid.*, p. 1019, Table 6, Column II
 16. Average of 137 normal tholeiitic basalts, *ibid.*, p. 1020, Table 7, Column VII
- * For 38034C and D, analysis by chemical methods (Analyst E. J. Tovey). All other analyses by X-ray fluorescence techniques (Analyst N. L. Marsh)
- † Also 0.02 per cent each of SO₂, BaO and S, and 0.25 per cent FeS₂
- ‡ Rest 0.07 per cent

TABLE 13A. C.I.P.W. NORMS OF SILICA-RICH PILLOW LAVAS

Norm Mineral	38034C		38034D		Mean	
	1	2	3	4	5	6
Quartz	48.19	44.44	40.89	35.76	44.22	39.44
Corundum	8.28	4.96	3.11	0.00	5.66	1.47
Orthoclase	13.59	14.77	7.09	7.68	10.64	11.23
Albite	0.93	1.02	28.43	30.04	14.72	15.65
Anorthite	5.81	15.93	8.08	17.34	6.63	19.47
Diopside	0.00	0.00	0.00	4.68	0.00	0.00
Wollastonite (D)	0.00	0.00	0.00	2.35	0.00	0.00
Enstatite (D)	0.00	0.00	0.00	1.12	0.00	0.00
Ferrosilite (D)	0.00	0.00	0.00	1.21	0.00	0.00
Hypersthene	15.04	16.07	4.76	2.86	10.03	10.64
Enstatite (H)	6.47	6.97	2.24	1.37	4.48	4.73
Ferrosilite (H)	8.56	9.09	2.52	1.48	5.55	5.90
Magnetite	1.59	1.74	0.43	0.43	1.01	1.01
Ilmenite	1.03	1.08	1.03	1.03	1.03	1.08
Apatite	0.07	0.07	0.14	0.14	0.12	0.12
Calcite	3.48	4.91	4.21

KEY TO COLUMNS:

- 38034C Calculated from original analysis
- 38034C Calculated volatile free and less 2 per cent silica veins
- 38034D Calculated from original analysis
- 38034D Calculated volatile free and less 2 per cent silica veins
- Mean Calculated from the mean of the original analyses
- Mean Calculated from the volatile free mean and less 2 per cent silica veins

On a polished surface of hand specimen 38034D, which was considered representative of the pillow, the area occupied by chalcedony veins was determined by measuring along a 3 mm spaced grid. The volume of veins was assumed proportional to the measured area. The densities of chalcedony and the lava are sufficiently similar that no significant error resulted when the mass of chalcedony, estimated at being 2 per cent of the rock, was subtracted from the silica component in the mean. This was recalculated to the original total (Table 13, Column 4). Other modifications to remove carbon dioxide and total volatiles as shown in Table 13, Columns 5 and 6 were also made. The norms calculated on the original analyses, their mean, and recalculated volatile-free analyses are presented in Table 13A.

For comparison, eight average analyses taken from Johannsen (1932, p. 265 and p. 398) and Nockolds (1954, p. 1012-1020) are given for rhyolite, rhyodacite, dacite, andesite and tholeiitic basalt. Comparison of Column 16 in Table 13 with the present analyses shows that the latter are not of basaltic composition. To determine whether the pillow lavas may be silicified andesite or basalt, silica in the mean was reduced to that of the average andesite and tholeiitic basalt (Table 13, Columns 15 and 16), and the other components recalculated to make a total of 100.0 per cent (Table 13, Columns 7 and 8). Even subtraction of 15 per cent silica produces a result which has more alumina, potash, ferrous iron, manganese and combined water, and less ferric iron, magnesia, lime, soda, titanium and phosphorus than average andesite. Relative to average basalt, the pillow lava after subtraction of 19 per cent silica has more alumina, potash, soda, manganese and combined water, and less ferric iron, ferrous iron, magnesia, lime, phosphorus and titanium. Although this comparison does not prove that the pillow lava is not silicified basalt or andesite, it does indicate that if the present composition of the pillow lavas is due to metasomatism, the processes are very complex and the silica-rich pillow lavas are not the result of simple silicification of pillowed andesite or basalt.

Apparent from Table 13, Columns 1 and 2, there is some disparity in the two analyses of the same pillow. This requires some explanation.

High combined water content indicates an unusual degree of post-eruptive hydration. Ewart (1971, p. 424) states that alkali leaching, especially sodium loss and oxidation of iron, are likely during hydration of volcanic glasses. This may explain the low soda and potash contents of the two samples, particularly the very low soda content of 38034C relative to 38034D. This sample was collected from near

the pillow margin and has a high content of combined water. However, both samples have a high ferrous to ferric iron ratio indicating little oxidation either during hydration or devitrification of glass, and indicates the absence of weathering.

Joplin (1964, p. 151-2) states that the process of devitrification of glassy selvages of pillow lavas shows that chemical diffusion occurs and that the devitrified glass differs chemically from the original glass and from the crystalline core. Using a series of analyses across a single pillow, Vallance (1960, p. 35-37) has shown that the selvedge is enriched in lime and ferric iron and depleted in silica and soda as a result of devitrification, and the core is concomitantly depleted in lime and ferric iron and enriched in silica and soda. With the exception of lime, these trends are observed for the two analyses presented. Ferrous iron and magnesia also appear to be enriched in the sample nearest the selvedge.

Recent studies by Ewart (1971) on rhyolite lavas support the conclusion that devitrification results in chemical redistribution in the lavas.

Although the overall lime and magnesia contents of the silica-rich pillow lavas may have been modified during hydration or later metasomatism, it seems unlikely that extensive alumina, iron, titanium, phosphorus or manganese metasomatism would occur. Metasomatism of andesitic or basaltic pillow lavas to produce the silica-rich pillow lavas therefore seems improbable, and certainly complex if it did occur. Although only two samples were analysed, comparison of the mean with averages from the literature suggests a rhyodacitic composition, with possibly some leaching of alkalis.

Consideration of the average norm of the samples (Table 13) favours a dacitic composition with normative orthoclase forming 24 per cent of the total feldspar, and the normative plagioclase being sodic labradorite, An₅₅. The presence of hypersthene in the norm does not detract from the description of the pillow lavas as rhyodacitic or dacitic, since the average dacite given in Table 13, Column 14, from Nockolds (1954, p. 1015) when treated by the same norm programme as the mean in Table 13A, Column 6, contains 7 per cent normative hypersthene. In addition, Joplin (1964, p. 164-5) describes dacites containing hypersthene phenocrysts which are commonly quite fresh even though hornblende and biotite phenocrysts show resorption. Williams and others (1955, p. 123-4) describe dacites containing modal hypersthene and regard the average composition of plagioclase, both porphyritic and micro-litic as calcic andesine, An₅₀.

Comparison of average trace element data in the literature for igneous rocks with the trace element data presented in Table 13B supports a rhyodacitic or dacitic composition for the silica-rich pillow lavas. References used were Wedepohl (1970) for La, Sn and Rb; Goldschmidt (1954) for Ba, Cu, Pb, W, Ni, Cr and Sr; Hawkes and Webb (1955) for Ba, Cu, Li, Pb, Sn, Cr, Zn and Ni; Ewart, Taylor and Capp (1968) for Rb, Ba, Sr, and Li; Ewart and Stipp (1968) for Rb and Sr; and Rankama and Sahama (1950) for Cu, Li, Pb, Sr and Ni.

TABLE 13B. TRACE ELEMENT ANALYSES OF SILICA-RICH PILLOW LAVAS (in ppm)

Trace Element	38034C	38034D	Average C & D
Ba	430	260	345
Cu*	130	90	110
Li	30	<10	15-20
Pb	20	20	20
Sn	7	5	6
Rb	150	120	135
Sr	15	70	43
W	10	<5	5-7
Ni*	130	50	90
Cr*	110	140	125
Zn*	310	100	205
Zr	30	35	33

* Analyses by chemical methods (Analyst E. J. Tovey)
Other elements by X.R.F. (Analyst N. L. Marsh)

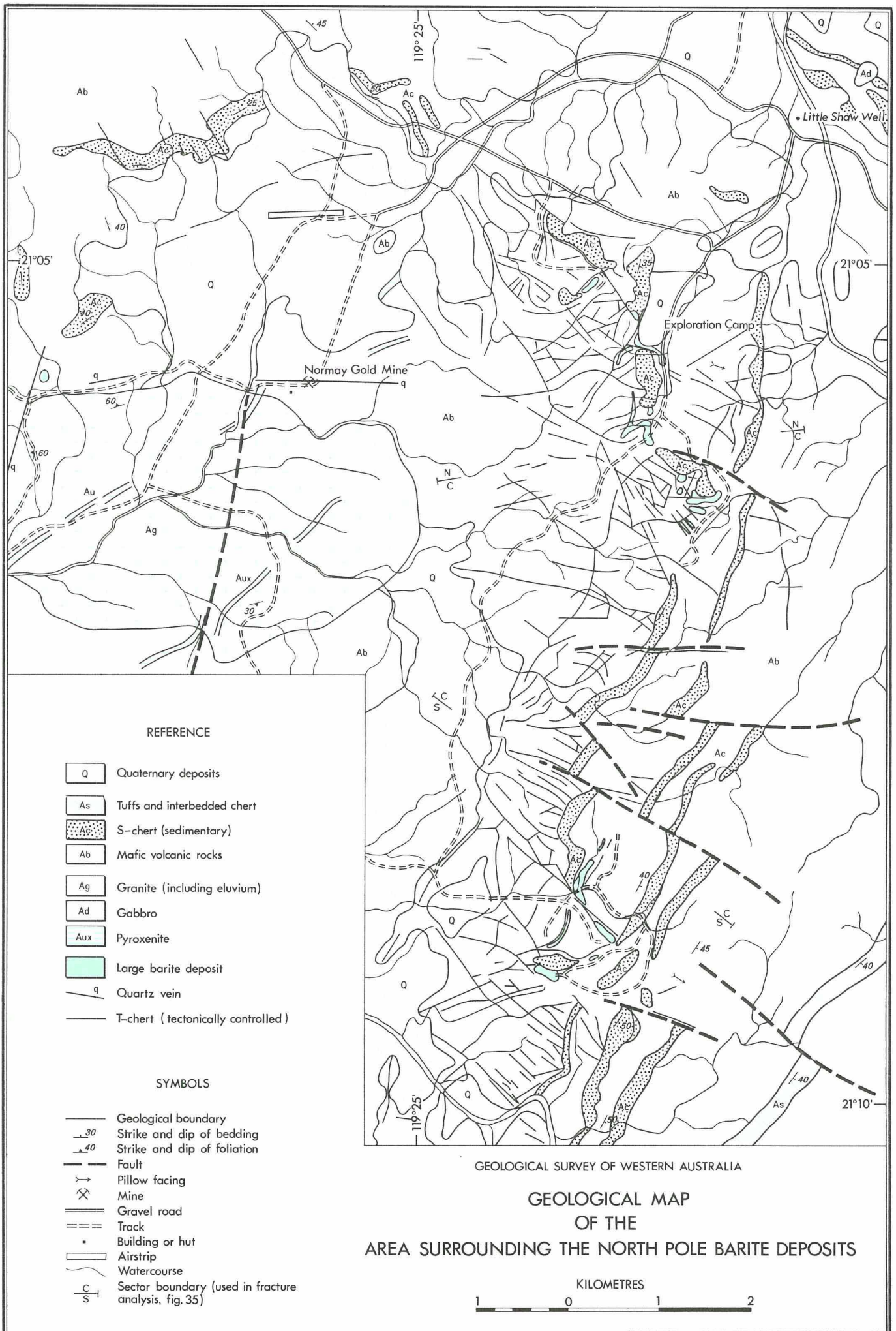

Figure 33

Concentrations of barium, lead, tin, rubidium and tungsten favour a felsic composition rather than andesite or basalt. Lithium is higher than the average for basaltic rocks. However, the concentrations of nickel and chromium favour an original andesitic composition for the pillow lavas although Joplin (1964, p. 166) presents analyses for a dacite and rhyodacite with 400 ppm and 800 ppm nickel oxide respectively. High copper and zinc concentrations which would appear to indicate a basaltic composition may have been concentrated by accessory pyrite occurring in the samples.

CONCLUSION

Chemical analysis and petrographic investigation show that the pillow lavas are of silica-rich and feldspathic composition. They are probably not silicified basaltic pillow lavas and certainly not carbonated basaltic pillow lavas. More analyses would be required to determine an exact composition of the pillows, with consideration of the variation noted by Vallance (1960, p. 35-37; 1969, p. 10-15) and others.

There are thought to be at least three other occurrences of silica-rich pillow lavas on the Marble Bar 1 : 250,000 sheet similar to the one studied. Since light-coloured pillow lavas in the Pilbara have been previously considered to be carbonated basaltic pillow lavas, these should be closely examined. If the suggestion that the silica-rich pillow lavas are rhyodacitic is correct, then this study demonstrates (a) that pillows may develop in lavas of rhyolite to dacite composition and (b) that such volcanics may occur in a subaqueous environment in the Pilbara Block. A subaqueous environment for this locality is further suggested by interpillow chert and palaeocurrent structures in the underlying volcanogenic sediments. Because of the current search of felsic volcanics for base metal deposits, the existence of siliceous submarine lavas deserves further investigation, since these indicate an environment suitable for the development of stratiform ore deposits (Stanton, 1960; 1961).

REFERENCES

- Ewart, A., 1971, Chemical changes accompanying spherulitic crystallization in rhyolitic lavas, Central Volcanic Region New Zealand: *Mineralog. Mag.*, v. 38, p. 424-434.
- Ewart, A., and Stipp, J. J., 1968, Petrogenesis of the volcanic rocks of the central North Island, New Zealand, as indicated by a study of Sr^{87}/Sr^{86} ratios, and Sr, Rb, K, U and Th abundances: *Geochim. et Cosmochim. Acta*, v. 32, p. 699-736.
- Ewart, A., Taylor, S. R., and Capp, A. C., 1968, Trace and minor element geochemistry of the rhyolitic volcanic rocks, Central North Island, New Zealand: *Contributions to Mineralogy and Petrology*, v. 18, p. 76-104.
- Finucane, K. J., 1936, Bamboo Creek Mining Centre, Pilbara Goldfield: Aerial Geol. Geophys. survey North Australia Rept. West. Australia No. 9, p. 3.
- Goldschmidt, V. M., 1954, *Geochemistry*: London, Oxford Press.
- Hawkes, H. E., and Webb, J. S., 1955, *Geochemistry in mineral exploration*: New York, Harper and Row.
- Hickman, A. H., and Lipple, S. L., in prep., Explanatory notes on the Marble Bar 1 : 250,000 geological sheet, W.A.: West. Australia Geol. Survey Rec.
- Johannsen, A., 1932, A descriptive petrography of the igneous rocks: Chicago, Univ. of Chicago Press, v. 2, p. 265 and 398.
- Joplin, G. A., 1964, A petrography of Australian igneous rocks: Sydney, Angus and Robertson, p. 151-2, and p. 164-6.
- Nockolds, S. R., 1954, Average chemical composition of some igneous rocks: *Geol. Soc. America Bull.* v. 65, p. 1007-1032.
- Noldart, A. J., and Wyatt, J. D., 1962, The geology of portion of the Pilbara Goldfield: West. Australia Geol. Survey Bull. 115.
- Rankama, K., and Sahama, Th. G., 1950, *Geochemistry*: Chicago, Univ. of Chicago Press.
- Stanton, R. L., 1960, General features of the conformable "pyritic" ore bodies: *Canadian Mining Metall. (C.I.M.) Bull.* 53, no. 573, p. 22-26.
- 1961, Geological theory and the search for ore: *Mining and Chem. Eng. Review*, v. 53, no. 7, p. 48-55.
- Vallance, T. G., 1960, Concerning spilites: *Linnean Soc. New South Wales Proc.*, v. 85, p. 1-52.
- 1969, Spilites again; some consequences of the degradation of basalts: *Linnean Soc. New South Wales Proc.*, v. 94, Part 1, p. 1-51.
- Wedepohl, K. H., 1970 (Ed.), *Handbook of Geochemistry*: v. 2, Parts 1 and 2: New York, Springer-Verlag, Berlin.
- Williams, H., Turner, F. J., and Gilbert, C. M., 1955, *Petrography, an introduction to the study of rocks in thin section*: San Francisco, Freeman and Co. p. 121-129.

THE NORTH POLE BARITE DEPOSITS, PILBARA GOLDFIELD

by A. H. Hickman

ABSTRACT

The largest known barite deposits in Western Australia occur at North Pole, 40 km west of Marble Bar. The barite, which occurs within a greenstone sequence of chert and mafic lavas, originated as an Archaean sedimentary deposit. During Archaean diastrophism this bedded barite was partially forced into the radial-concentric fracture system of a large dome.

The North Pole deposits are well positioned to supply oil exploration companies working on the continental shelf off northwestern Australia, and could also greatly increase Australian exports of the mineral. An exploration programme is being conducted to determine mining feasibility.

INTRODUCTION

In 1912 T. Blatchford of the Geological Survey reported a large lode of barite to the southeast of the North Pole Gold Mining Centre, 40 km west of Marble Bar. Though impressed by the size and purity of the deposits, Blatchford (1912) stated that inaccessibility and limited demand would preclude mining. In recent years, however, rapidly expanding markets and improved mining methods have meant that extraction of the mineral must now be viewed as a potential commercial proposition. Associated Minerals Pty. Ltd. currently hold Mineral Claims 45/1008, 1102, 1418, 1519-23, 1604-05 and 6462 covering most of the area's known deposits and Dresser Australia Pty. Ltd. are conducting a

drilling programme to obtain an accurate estimate of reserves. Preliminary geological investigations by Dresser have indicated barite reserves of several million tonnes.

Prospecting, road construction, drilling and sampling are currently continuing at the prospects. In 1970, 508 t of barite were extracted.

LOCATION, ACCESS AND FACILITIES

The prospects are situated 120 km southeast of Port Hedland at Lat. 21° 06'S and Long. 119° 27'E (Fig. 33). Road access from Port Hedland is by way of the Great Northern Highway for 100 km and by graded track for a farther 55 km. An exploration camp has been established 2 km to the south of Miralga Crossing and a nearby bore drilled to a depth of 20 m maintains a good supply of water.

GEOLOGY OF NORTH POLE

The regional geology of the area around North Pole is depicted on the Marble Bar sheet of the 1:250,000 Geological Series (Noldart and Wyatt, 1962; Hickman and Lipple, in prep.). The barite prospects are situated within one of the Pilbara's largest Archaean greenstone belts. Most such belts are usually broadly synclinal, but at North Pole a central dome, about 35 km in diameter, is developed. Between the North Pole Mining Centre and the barite prospects, erosion of the dome has exposed a core of granite. Greenstone xenoliths in the margin of this body show it to be intrusive, though no significant structural discordance is apparent on a regional scale.

STRATIGRAPHY

The Archaean succession enveloping the granite is over 15 km in true thickness and of varied lithological composition. It is remarkably undeformed compared with similar successions in adjacent belts and has only been subjected to lower greenschist facies metamorphism.

The lower part of the stratigraphic succession is outlined in Table 14.

TABLE 14.

	Description	True thickness
	Felsic lavas and metasedimentary rocks	
5	Mafic pillow lavas with some chert and agglomerate bands	6 km
4	Tuff, chert and metasedimentary rocks	0.5 km
3	Mafic lavas with some chert and metasedimentary rocks	5 km
2	Thick chert interbedded with mafic lavas	1.5 km
	Barite deposits	
1	Mafic lavas (oldest)	2 km
	Granite (intrusive)	

Apart from testifying to the subaqueous deposition of the succession, the widespread occurrence of undeformed pillow structures in mafic lavas suggests that its present thickness closely approximates its original thickness.

Bedded chert ("S-chert" of Dunbar and Rogers, 1961) within the succession may have been formed by chemical precipitation. According to Turner and Verhoogen (1960, p. 261), thick beds of chert are commonly found within this type of sequence and are derived from late magmatic, silica-rich emanations. Alternatively, the chert may have originated from the weathering of volcanic ash or by the replacement of pre-existing sedimentary units. A minor part of the succession is composed of tuff, mudstone and quartzite.

Figure 33 shows that the barite deposits are all situated close to, and generally underneath, the lowest bedded chert unit of the succession. The northern and southern prospects are 8 km apart, yet between them the "mineralized belt" is no more than 0.5 km wide. Within this belt the barite is

interlayered with chert, either in sub-vertical vein-like structures (Fig. 34C) or in beds which, in outcrop, appear to form part of the stratigraphic succession (Fig. 34B). About 6 km to the west of the northern prospects, another deposit shown on Figure 33 is situated at approximately the same stratigraphic level.

The origin of the barite is discussed later.

STRUCTURE

Whereas the regional distribution of the barite deposits is stratigraphically controlled, field observations reveal that structural features govern their size, shape and lateral distribution along strike. The most impressive aspect of the area around the prospects, both on the ground and on the geological map, is its box-work pattern of ramifying cherts (Fig. 34A). So numerous and closely spaced are these cherts that they form a rugged range of hills rising more than 100 m above the surrounding countryside. The barite prospects are all situated within this box work.

Folding

The North Pole area is structurally a dome. Like other granite domes of the Pilbara, this fold is surrounded by deep synclinal greenstone belts. Apart from an anticlinal extension towards the southwest, the dome is only slightly elongate about a north-northeast to south-southwest axis and generally measures about 35 km in diameter. Lower Proterozoic strata resting unconformably on the eroded surface of the fold establish it as being of Archaean age.

The geometry of the dome is somewhat complicated by what appear to be parasitic folds on its flanks. Where anticlinal, these structures contain chert box works.

At the barite prospects several interesting examples of folding occur. Interlayered barite and chert beds contain tight to isoclinal folds and, in places, mesoscopic thrusts can be seen (Fig. 34H). These structures may represent early gravitational slumping, or they could be interpreted as drag folds accompanying flexural slip during uplift of the dome. Cleavage planes within the barite are commonly slightly crenulated revealing the presence of deformation subsequent to recrystallization.

Tectonic foliation associated with the main folding is locally restricted to a biotite foliation in the granite, a weakly developed bedding plane schistosity in some of the mafic lavas and a sub-vertical strain-slip cleavage disposed radially about the eastern and southern flanks of the dome. Though rather uncommon, this latter structure is of interest since it could have been formed by circumferential compression associated with upward movements in the centre of the fold (c.f. radial folding about salt diapirs).

Fracture analysis.

Many of the world's deposits of barite and the associated minerals fluorite, galena and sphalerite occur in fractured domes (Dunham, K. C., 1948; Wisser, 1960; Dunham, A. C., and Hanor, 1967). In describing mineral deposits of the Central United

FIGURE 34 (opposite)

- Photographs of structures in the barite deposits
- A A chert box-work pattern near the exploration camp.
 - B Interbedded chert (dark) and barite (2 km south of the exploration camp).
 - C Vertical barite veins (light) within mafic volcanic rocks and chert (2-3 km south of the exploration camp).
 - D T-chert cross cutting barite layers (near exploration camp).
 - E Barite interlayer surface from above (near exploration camp).
 - F Large bulbous swelling of barite layers (near exploration camp).
 - G A reniform structure in interbedded barite and chert (near exploration camp).
 - H Isoclinal folding within the barite. Note thrust plane, right centre (near exploration camp).

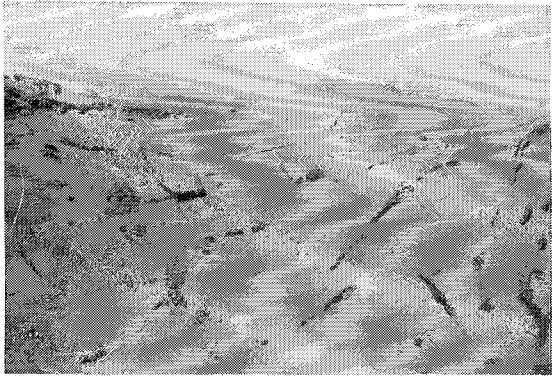

A

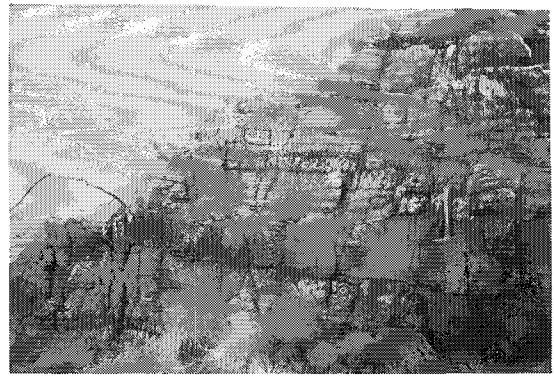

B

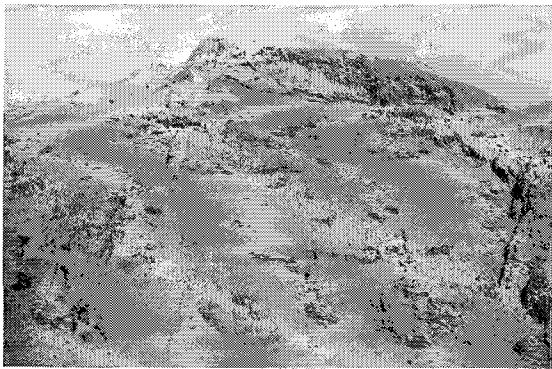

C

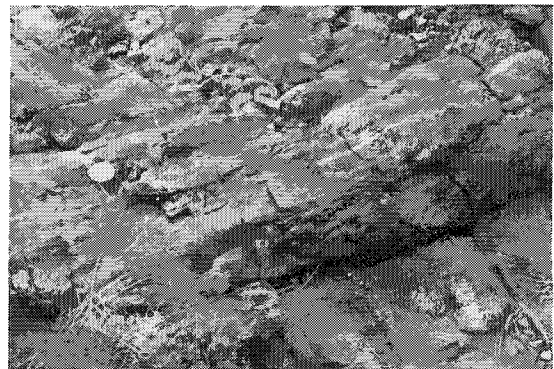

D

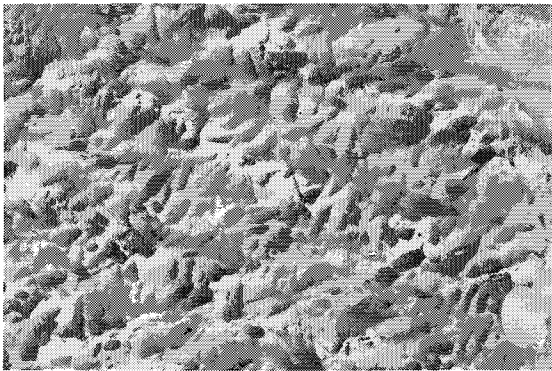

E

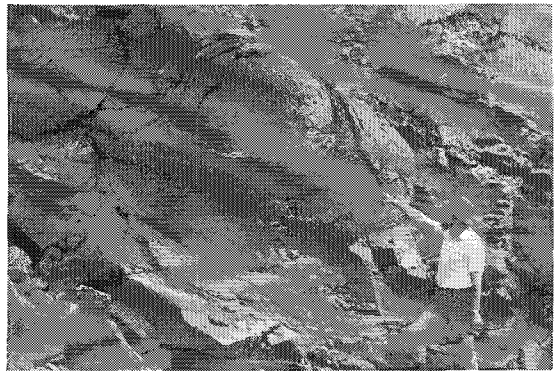

F



G

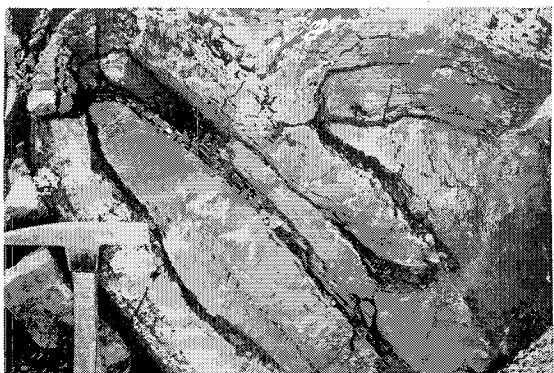

H

Figure 34

States Heyl (1968) states that "known major mineral deposits and many promising sulphide occurrences are located along complex fault systems and particularly over structural domes at intersections of fault systems". Badgley (1965) expresses the view that fracture intensity studies are important in the pin-pointing of ore bodies.

Irrespective of whether the North Pole barite is of hydrothermal or sedimentary origin, it is obvious in the field that many of the deposits now occupy veins within the fracture system of the dome. A study of this system may thus help to determine the distribution of the barite.

Air-photographs of the North Pole area reveal a well developed lineament pattern. On the ground, these features prove to be faults, joints and veins of "T-chert" (tectonically controlled chert, Dunbar and Rogers, 1961). The latter can be distinguished from S-chert (sedimentary) by their lack of internal banding, their rectilinear outcrop pattern and their typically discordant relations to adjacent strata. Intrusive in character, the T-chert has entered the dome's fracture system of joints and faults.

Figure 35 presents a statistical analysis of T-chert strike frequency in three sectors of the area shown on Figure 33. The three component diagrams of this figure reveal that the chert veins exhibit two strike maxima at about 300° and 050°. Around the flanks of the dome a radial fault system

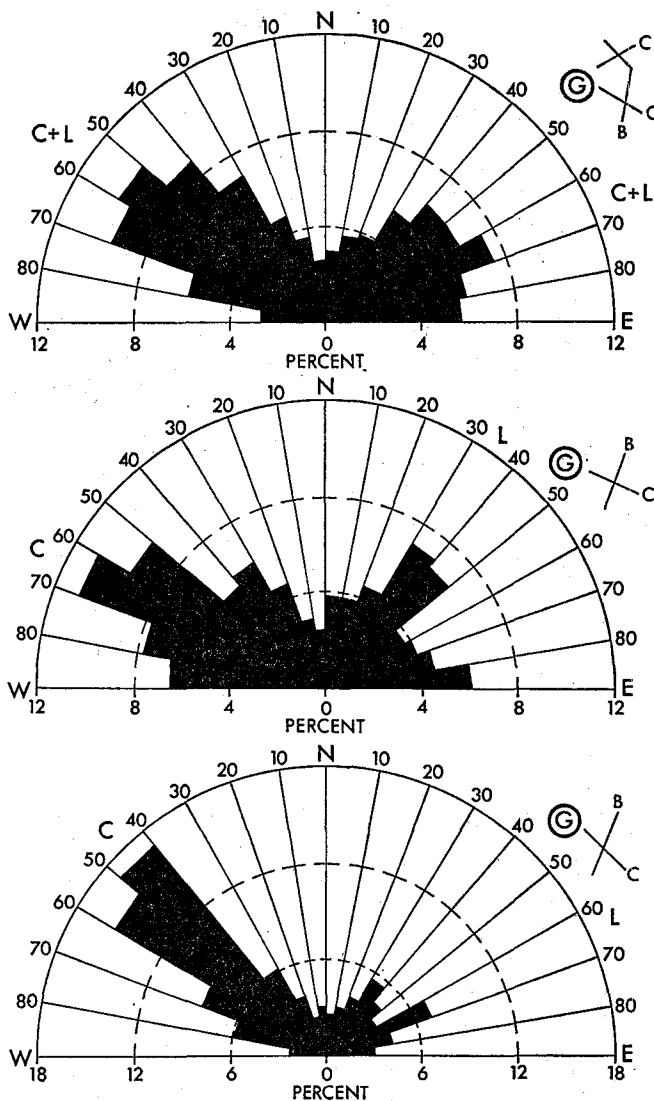

Figure 35. Strike frequency diagrams for T-chert in the area of the barite prospects

is developed but Figure 35 does not reveal any tendency towards radial orientation of T-chert bodies within the area of the prospects. This appears to be due to the presence of local folding in the northern sector. Cross fractures associated with this folding are oriented both in northeast and northwest directions according to which limbs they occupy.

Since the axis of the dome trends north-northeast, the dominant west-northwest set of T-chert veins in the central and southern sectors clearly represent cross fractures on the major structure. The east-northeast-striking T-chert veins here belong to a complementary longitudinal set.

The dome's fracture system of joints and faults must have been formed by tensional stress either during or shortly after uplift. T-chert was probably derived by the solution of S-chert in areas of maximum strain and migration of the material so obtained to regions of low pressure. Barite "veining" probably occurred at about the same time.

BARITE DEPOSITS

The barite deposits are largest at fracture intersections and in regions of minor flexure. In such areas they not uncommonly measure 20 m in width and may be over 50 m long. Such ore bodies may be lenticular, tabular, wedge shaped or zigzagged according to local structure. In contrast, barite deposits within S-chert occur in tabular masses and are stratigraphically controlled. This type of barite is often closely interbedded with sedimentary chert (Fig. 34, B). The extension of such deposits at depth is more predictable than that of veins but, in general, they constitute thinner bodies.

The colour of the barite is pale blue-grey. It is coarsely crystalline and occurs in discrete layers about 10 cm to 20 cm thick. Inter-layer surfaces are composed of crystal faces which closely interlock with those of adjacent layers (Fig. 34, E); these surfaces are often slightly iron stained.

Occasionally the layers of barite are isoclinally folded and also exhibit mesoscopic reniform structures up to 2 m across (Fig. 34, F). The barite is of high grade except where mixed with chert, agate or quartz.

ORIGIN

Since the deposits are strongly folded and injected by Archaean T-chert (Fig. 34, D), they must be of Archaean age. This point is emphasized by the degree of stratigraphic control over the positioning of the ore bodies.

Three possible origins should be considered for the North Pole barite deposits:

- (1) Formation by the replacement of pre-existing sediments
- (2) Precipitation from hydrothermal solutions
- (3) Deposition as bedded sedimentary barite

Replacement is a selective process and it might reasonably be expected that relics of the original lithology would remain had the deposits been formed in this way. No such relics have been observed.

Hydrothermal ore bodies take many forms. It could be argued that the layered nature of the barite originates from spasmodic crustification and that the deposits conformable with bedded chert testify to lateral veining. Under such a hypothesis, the stratigraphic control exerted on the barite's distribution might be due to restriction of the upward migrating solutions beneath a thick chert. A chert does exist along, and generally above, the line of barite prospects, and this is the lowest major chert of the succession. Ore fluids could have entered the area during, or shortly after, the emplacement of the North Pole granite, rising through the dome's fracture system to reach the present level of the deposits.

Weighted against the hypothesis of hydrothermal veining are several strong arguments in favour of a sedimentary origin:

- (1) Where least deformed, the barite occurs in layers structurally concordant with adjacent bedded chert and the surrounding mafic lavas
- (2) The barite deposits are confined to a single stratigraphic level for 8 km along strike
- (3) Individual barite layers are never observed to wedge out or cross cut; they present a bedded form
- (4) The barite deposits are essentially monomineralic in composition
- (5) No accompanying sulphide mineralization is present
- (6) No wall-rock alteration has been observed
- (7) On breaking and crushing, the barite emits a strong fetid odour. This is also a characteristic of certain bedded barite deposits in the United States (Mills and others, 1971)
- (8) Interlayered barite and chert are considerably folded
- (9) The barite-chert association is common in sedimentary barite deposits (Perry and others, 1971).

It is concluded that the North Pole barite deposits are probably of sedimentary origin. During uplift of the North Pole dome they constituted a mechanically active layer and were much folded and ruptured. Joints and faults belonging to the dome's fracture system were locally invaded by diapiric folds of the bedded barite.

GRADE AND ORE RESERVES

The grade of the main deposits, as estimated from surface inspection and sampling, is high, although in certain cases the barite is contaminated with chert. Due to local complexities of structure, all the prospects must be carefully tested before any reliable estimate of reserves can be obtained. Surface outcrops indicate that the deposits are the largest in Western Australia and possibly in Australia. The area's regional structure suggests that the mineralization belt dips westwards from the prospects at about 40°. A surface gravity survey might help to provide an indication of barite reserves at depth.

CONCLUSIONS

The North Pole barite deposits are the largest yet discovered in Western Australia and, if current testing by Dresser Australia Pty. Ltd. yields favour-

able results, production at a rate of 50,800 t per year could both supply the oil exploration companies working on the continental shelf off north-western Australia and take advantage of overseas markets in Indonesia Papua-New Guinea and South East Asia.

REFERENCES

- Badgley, P. C., 1965, Structural and tectonic principles: New York, Harper and Row, p. 98-152.
- Blatchford, T., 1912, Mineral resources of the north-west division: West. Australia Geol. Survey Bull. 52, p. 28-30.
- Dunbar, C. E., and Rodgers, J., 1961, Principles of stratigraphy: New York, John Wiley and Sons, Inc., p. 248.
- Dunham, A. C., and Hanor, J. S., 1967, Controls on barite mineralization in the Western United States: Econ. Geol. v. 62, p. 82-94.
- Dunham, K. C., 1948, Geology of the Northern Pennine Orefield, v. 1, Tyne to Stainmore: Great Britain Geol. Survey Mem. (cit. Dunham and Hanor, 1967).
- Heyl, A. V., 1968, Minor epigenetic, diagenetic, and syngenetic sulfide, fluorite, and barite occurrences in the Central United States: Econ. Geol. v. 63, p. 585-594.
- Hickman, A. H., and Lipple, S. L., in prep., Explanatory notes on the Marble Bar 1:250,000 Geological Sheet W.A.: West Australia Geol. Survey Rec.
- Mills, J. W. Carlson, C. L., Fewkes, R. H. Handlen, L. W. Jayprakash, G. P. Johns, M. A., Morganti, J. M., Neitzel, T. W., Ream, L. R., Sandford, S. S., and Todd, S. G., 1971, Bedded barite deposits of Stevens County, Washington: Econ. Geol., v. 66, p. 1157-1163.
- Noldart, A. J., and Wyatt, J. D., 1962, The geology of portion of the Pilbara Goldfield: West. Australia Geol. Survey Bull. 115.
- Perry, E. C., Jr., Monster, J., and Reimer, T., 1971, Sulfur isotopes in Swaziland system barites and the evolution of the Earth's atmosphere: Science (AAAS), v. 171, No. 3975, p. 1015-1016.
- Turner, F. J., and Verhoogen, J., 1960, Igneous and metamorphic petrology (2nd ed.): New York, McGraw-Hill Book Co., p. 261.
- Wisser, E., 1960, Relation of ore deposition to doming in the North American Cordillera: Geol. Soc. America, Mem. 77, (cit. Dunham and Hanor, 1967).

THE PETROLOGY OF AN ULTRAMAFIC LAVA NEAR MURPHY WELL, EASTERN GOLDFIELDS, WESTERN AUSTRALIA

by J. D. Lewis and I. R. Williams

ABSTRACT

A partially serpentinized olivine peridotite lava flow from Murphy Well, 185 km north-north-east of Kalgoorlie, is 162 m thick and is mainly a porphyritic peridotite containing about 60 per cent euhedral olivine crystals set in a matrix of acicular diopsidic clinopyroxene and devitrified glass. A flow top 21 m thick contains amygdales and dendritic

olivine crystals in a matrix of clinopyroxene and glass. Serpentinization is partial and original igneous textures have been preserved.

Chemical and modal analyses are presented which show that there has been no differentiation either by gravity after extrusion or flow differentiation during extrusion. It is thought that the magma was extruded as a mobile, essentially crystal-free liquid, supersaturated in volatiles.

Electron probe analyses indicate a forsteritic olivine (FO_{90-95}) and an alumina-rich clinopyroxene in the range salite-calcic augite. Probe analysis of the devitrified glass and other evidence support the hypothesis that serpentinization involved only local redistribution of elements.

A consideration of the morphology of the amygdales shows that the dendritic olivine of the flow top crystallized from a liquid which remained mobile until much of the olivine had crystallized out.

INTRODUCTION

The concept of an essentially liquid ultramafic magma being emplaced high in the earth's crust or extruded as a lava has recently been revived by geologists in Canada, South Africa and Western Australia (Naldrett and Mason, 1968; Viljoen and Viljoen, 1969a; Nesbitt, 1971) to explain spinifex textured (i.e. quench textured) peridotites observed in Archaean greenstone belts. The "crystal mush" hypothesis of Bowen (1928) does not explain such rocks and recent writers suggest a magma with 20 per cent or less olivine crystals and an ultramafic liquid fraction capable of crystallizing a peridotite containing about 40 per cent olivine.

The purpose of the present paper is to describe an ultramafic body from Yundamindra Station, 185 km north-northeast of Kalgoorlie which the authors believe to be a peridotite lava extruded as an essentially crystal-free liquid. The rocks are of Archaean age and several flows are involved in a small, relatively poorly exposed area of about 1 km². Only a single flow unit, 162 m thick, will be described in this report. The exposure is 12 km southeast of Yundamindra homestead and access is gained from the station track linking Murphy Well with Bore Well (Fig. 36). The sample area lies about 100 m south of the track on the gentle southeast slope of a low ridge.

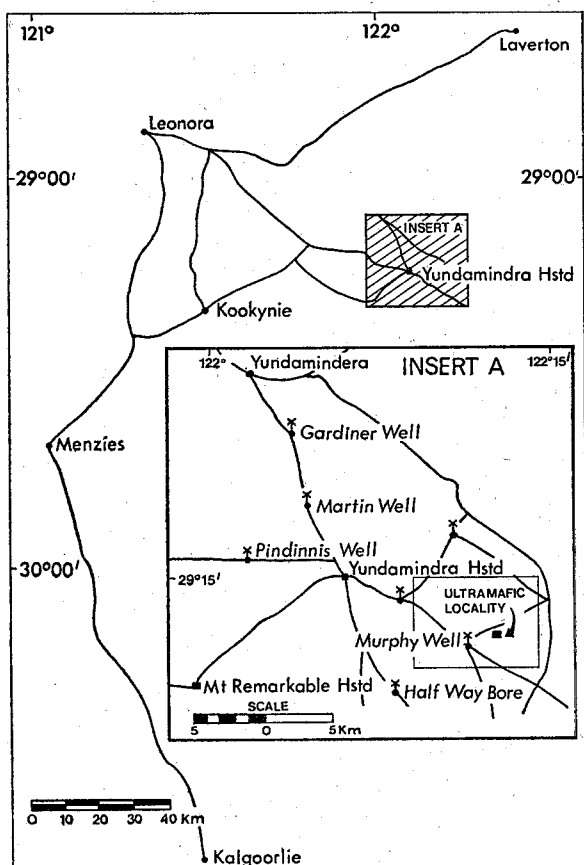

Figure 36. Locality map Murphy Well ultramafic body

The exposure was mapped by C. F. Gower in 1970 during the course of regional mapping on the Edjudina 1 : 250,000 sheet and the regional geology has been described by Williams and others (1971).

GENERAL GEOLOGY

The metamorphosed layered succession in the Murphy Well area (Fig. 37) is part of the largely mafic Morelands Formation. It is overlain 5 km east of Murphy Well by mixed felsic and clastic rocks of the Gindalbie Formation. Three kilometres west of Murphy Well the Morelands Formation has been intruded by a biotite granite pluton with a metamorphic aureole up to 1 km wide.

The Morelands Formation in this area consists mainly of regionally metamorphosed, tholeiitic basalts together with metamorphosed extrusive ultramafic and ultrabasic rocks. The ultramafic rocks, including the Murphy Well ultramafic body, are peridotites and high-magnesian basalts. The formation also contains metamorphosed, homogeneous dolerite and gabbro, layered gabbro and serpentinized extrusive peridotite and dunite bodies which are believed to be co-magmatic and concomitant with the extrusive mafic and ultramafic rocks. Minor cherts, fine-grained clastic and felsic rocks make up the remainder of the Morelands Formation. Laterite and jasperoidal cappings are common on the ultramafic rocks.

The Morelands Formation has been tightly folded into south-plunging isoclinal structures and the regional dip is vertical to steeply east. The Murphy Well ultramafite is believed to be on the eastern limb of a south-plunging syncline.

The Honman Fault, a large dislocation zone marked by a prominent line of quartz blows, trends northwesterly across the area a little south of Murphy Well. The fault has an apparent sinistral strike slip movement. A north-trending fault, with relative downthrow to the west, lies a little to the east of Murphy Well.

THE MURPHY WELL ULTRAMAFIC LAVA

The Murphy Well ultramafic body is poorly exposed over a strike length of 500 m; it passes beneath alluvium to the south and laterite to the north. Where sampled the body dips vertically and has an estimated thickness of 162 m. The western margin (top) of the flow is marked by a conspicuous zone of amygdales and dendritic olivine up to 21 m wide. The eastern exposures of the peridotite, in contrast, consist of close-packed, medium-grained equant olivine crystals. The various textures of the rock are well displayed on weathered surfaces.

A thin (about 1 m) bed of cherty tuff marks the western boundary of the body which overlies felsic extrusive rocks. At least two further fine-grained ultramafic bodies overlie the cherty tuff but these both lack amygdaloidal peridotite with dendritic olivine.

PETROLOGY

Throughout its thickness the flow is a dense, fine-grained, blue-black, partially serpentinized peridotite. The base of the flow is marked, in parts, by a narrow zone of pale green, bleached serpentinite and the top is indicated by amygdaloidal peridotite the amygdales imparting a distinctive knobby appearance to the rock. The mineralogy is constant throughout the thickness of the flow and consists of partially serpentinized olivine (FO_{90-95}), fresh clinopyroxene and devitrified glass. Despite serpentinization the original textures of the rock

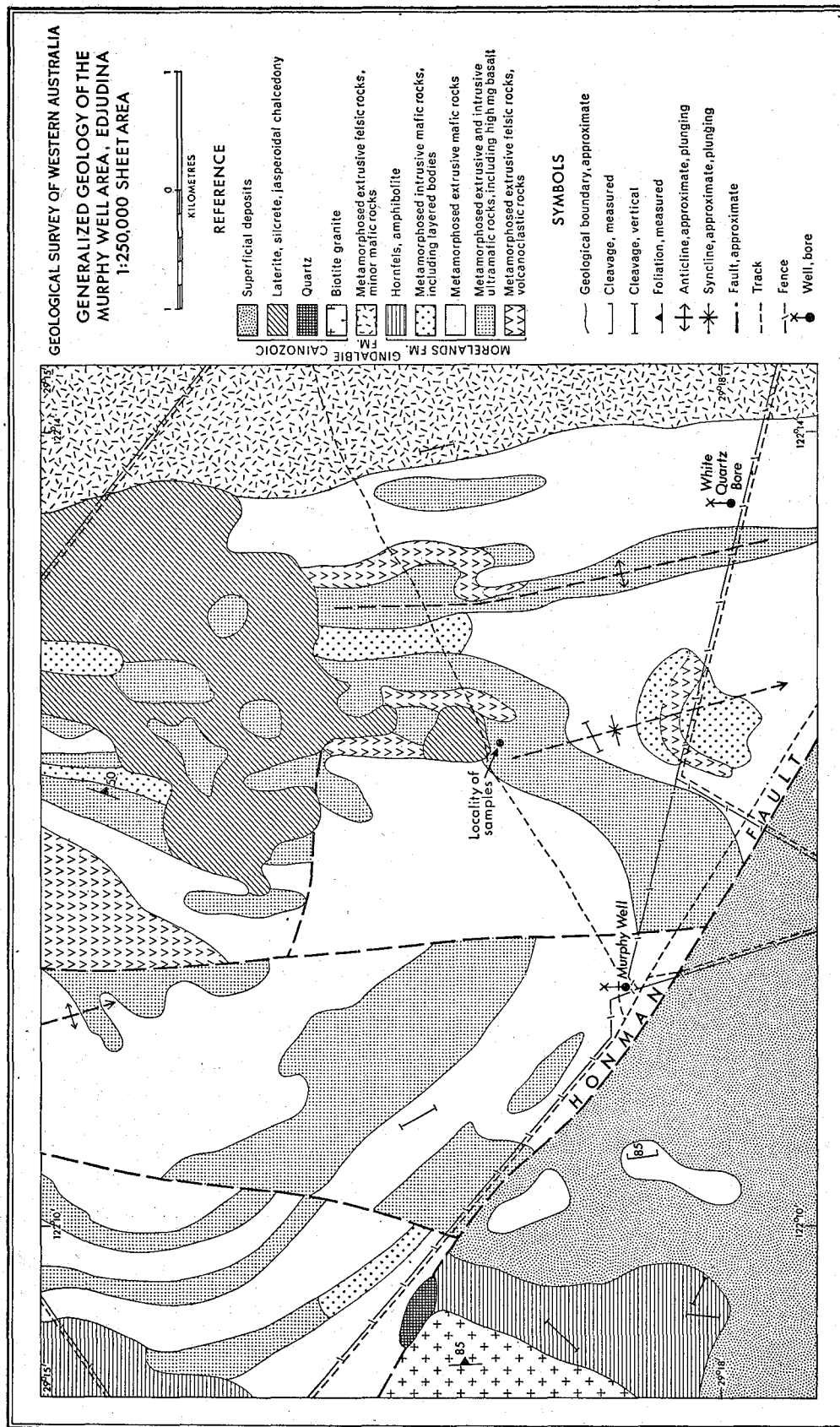

FIGURE 38 (opposite)

Photomicrographs of amygdaloidal peridotite, Murphy Well (Arrows point to top of flow).

- A 26652/A Amygdale showing pyroxene-rich tail and an upward projection. To the right of the amygdale is a plumose olivine crystal.
- B 26652/A Well developed amygdale and pyroxene tail showing zonation chlorite and calcite filling the vesicle and an arc of magnetite grains within the tail indicating a former position of the amygdale.
- C 26652 Small amygdale and dendritic olivine. The skeletal olivine grains are in optical continuity throughout much of the photograph.
- D 26652/A Plumose olivine grains showing a directional texture.



A



B



C

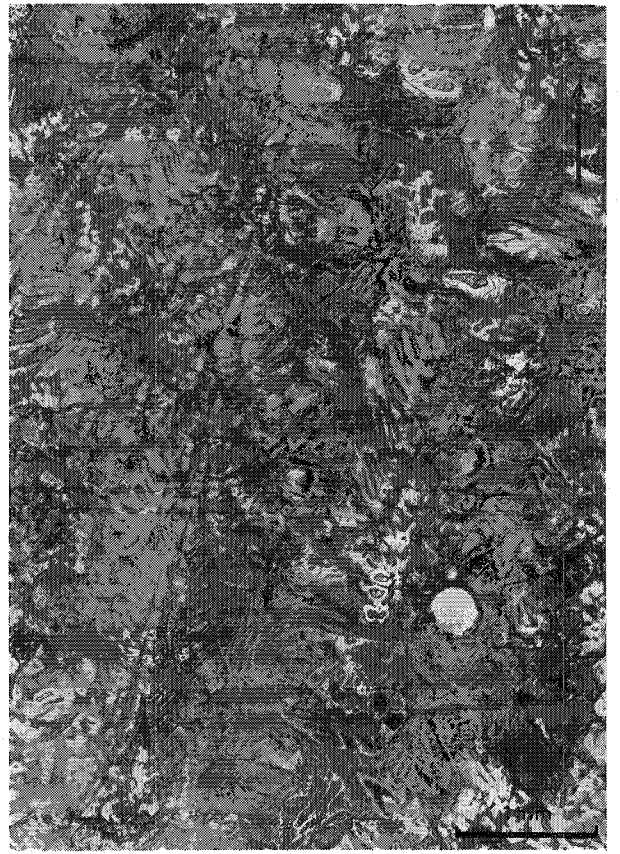

D

Figure 38

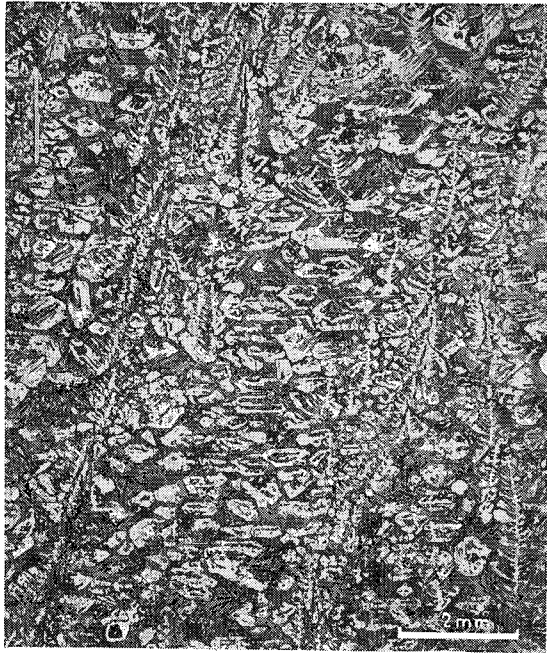

A

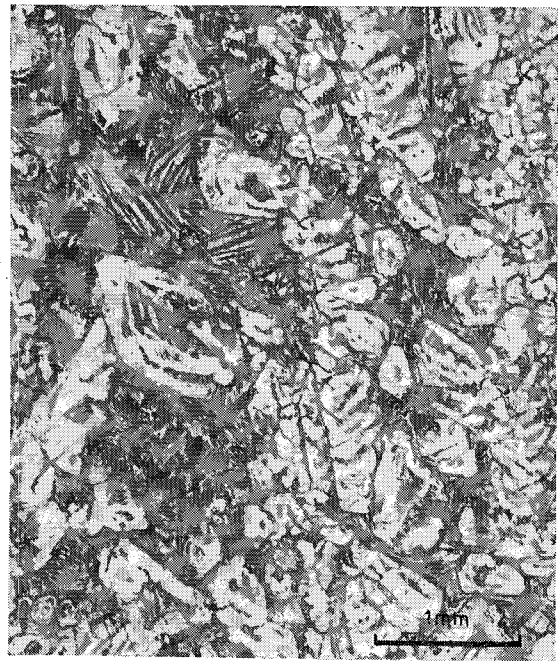

B

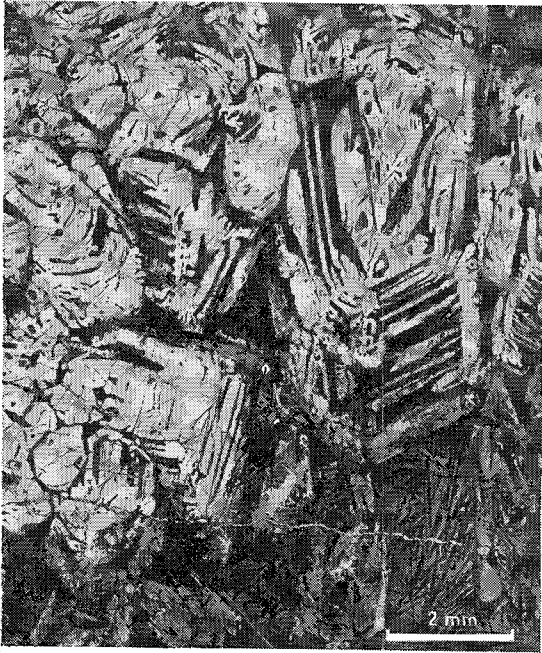

C

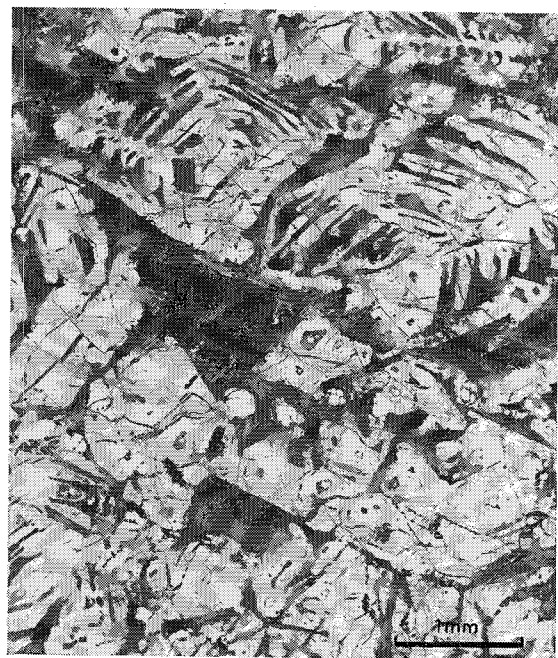

D

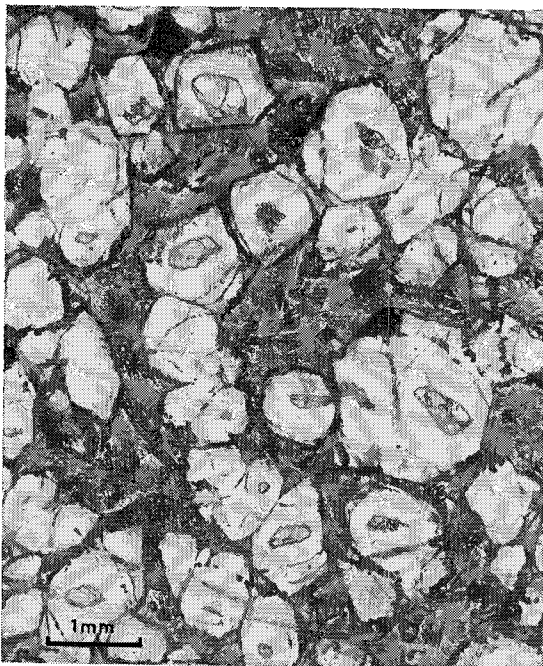

E

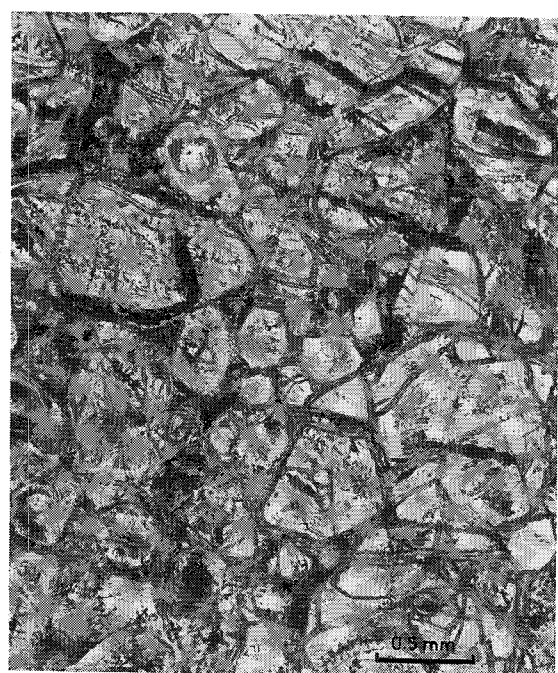

F

are exceedingly well preserved (Figs. 38 and 39) and allow the flow to be divided into several textural types as follows:

- (4) Amygdaloidal peridotite with dendritic olivine crystals
- (3) Transitional zone with skeletal olivine
- (2) Porphyritic peridotite with equant euhedral olivine phenocrysts
- (1) Basal zone of olivine-rich peridotite with equant olivine crystals.

(1) *Basal zone*

No transition can be seen in the field between this zone and the bulk of the flow but the basal zone probably occupies the lowest 20 to 30 m of the flow. The rock is totally serpentinized but in thin section (18402)* textures are preserved which show that originally it consisted of closely packed equant olivine grains 1 to 2 mm long with 30 per cent matrix consisting of acicular clinopyroxene and glass and a few grains of chromite (Table 15, Column 1 and Fig. 39, F). Secondary magnetite is concentrated into bands, giving the rock a layered appearance which is not shown by the olivine crystals.

A thin section (18401) of the pale green, bleached serpentinite which marks the base of the flow has few textures preserved except the rough outline of some large olivine crystals up to 4 mm long and a few chromite octahedra up to 0.8 mm across. The rock is now largely antigorite with a dusting of secondary opaque oxides and, in addition to the chromite, contains a few small relics of red-brown phlogopite which may also be an original mineral.

TABLE 15. MODAL ANALYSES OF ROCKS FROM MURPHY WELL

	18402	18403	18404	26652
Serpentine	69.9*	45.0	53.1	50.6
Olivine	10.9	7.5	6.9
Clinopyroxene	} 30.1	21.9	18.9	26.0
Chromite		4.5	4.6	3.2
Glass		17.7	15.9	9.1
Amygdales	4.2

* 18402 is totally serpentinized, this figure refers to pseudomorphs after olivine.

(2) *Porphyritic Peridotite*

This rock type forms the bulk of the flow and with the transition zone to the amygdaloidal flow top is about 120 m thick. The rock is fairly fresh and much of the original mineral assemblage is still present. Textures have been particularly well preserved so that the modal analyses of two specimens (18403, 18404) presented in Table 15 indicate with reasonable accuracy the original composition of the rock. This zone of the flow is an olivine peridotite containing about 60 per cent of euhedral, equant, olivine crystals from 0.5 to 2 mm long with a few larger crystals up to 3 mm long in a matrix of acicular clinopyroxene crystals up to 1 mm long, a pale brown glass and a few euhedral or skeletal chromite crystals up to 1 mm across.

The olivine has been extensively serpentinized but most crystals retain kernels of unaltered olivine. Serpentinization has forced excess iron in the olivine to the margins of the crystal where it now forms a fringe of granular magnetite (see

Fig. 39, E and Fig. 40). In modal analyses this fringe was counted with serpentine as it belongs to original olivine.

The remaining 40 per cent of the rock consists of fresh acicular clinopyroxene and a little chromite in a glassy matrix. The pyroxene needles range from small hair-like crystals to more prismatic crystals up to 1 mm long and although some appear to have nucleated on olivine crystals the majority occur randomly throughout the glass. Chromite grains, which make up about 4.5 per cent of the rock, are sometimes euhedral octahedra but more commonly are skeletal crystals. The glass matrix is everywhere devitrified although under low power magnification it commonly appears isotropic. Under high power magnification it is seen to consist of a very fine-grained feathery aggregate of minerals with a very low birefringence, possibly a chlorite, with a fine dusting of exsolved iron oxide.

The overall texture of the peridotite in this zone is porphyritic, with relatively large euhedral olivine crystals set in a fine-grained matrix. Although this texture has been used (eg. Naldrett and Mason, 1968) to suggest that the olivine formed during an early phase of crystallization prior to extrusion it will be argued later that the olivine of the Murphy Well peridotite crystallized after extrusion.

(3) *Transition zone*

The transition zone cannot be distinguished in the field but from the examination of thin sections is a narrow zone that begins near the top of the porphyritic zone and extends into the lower part of the amygdaloidal flow top. The transition zone is characterized by the development of large (up to 6 mm across) discrete, skeletal olivine crystals which are easily distinguished from the euhedral non-skeletal olivine of the porphyritic zone below but do not take on the complex dendritic habit of the olivine in the overlying amygdaloidal zone. The transition zone is not a distinct zone and Saratovkin (1959) maintains that there is no essential difference between skeletal and dendritic crystals. The physical conditions of this zone, therefore, represent the onset of conditions which lead to the delicate forms to be described in the amygdaloidal zone. The mineralogy and texture of the glass and clinopyroxene fraction is similar to that of the porphyritic zone and only the habit of the olivines is different. The nature of this difference is shown in Figures 39, B, C and D where 18405 is free from amygdales and shows both equant and skeletal forms while in 18421 the skeletal forms have developed into more complex dendritic olivine in a rock which contains a few small amygdales.

(4) *Amygdaloidal peridotite*

The uppermost 21 m of the flow is well defined in the field by the presence of numerous amygdales which on weathered surfaces of the peridotite appear as small protuberances or pits up to 1 cm across. In thin section, apart from the amygdales, the rock is distinctive because of the dendritic habit of the olivine. Modally the rock is similar to the porphyritic peridotite as shown in Table 15 and the mineralogy and degree of serpentinization is also similar.

Initially the olivine appears to be in the form of small skeletal crystals (Fig. 38, C and 39, A) but examination of the extinction of the olivine remnants reveals optical continuity over areas up to 1 cm across. This shows that the skeletal forms are part of a larger dendritic crystal. These are the largest olivine crystals found in the flow although about 40 per cent of their volume is made up of glass and pyroxene needles either enclosed in the skeletal parts or between the branches of the large dendritic crystal. Individual dendritic crystals appear to be in random orientation and xenomorphic towards each other. A second, less common, type of olivine crystal is plumose in outline (Fig. 38, D and 39, A). Plumose crystals are elongated skeletal olivines up to 5 mm long which

* Thin section numbers refer to G.S.W.A. collection

FIGURE 39 (opposite)

Photomicrographs of the Murphy Well peridotite lava

- A 18420 Plumose and dendritic olivine of the amygdaloidal zone.
- B 18421 Transition zone : skeletal and dendritic olivine in a peridotite with a few small amygdales.
- C 18405 Transition zone : skeletal olivine.
- D 18405 Transition zone : skeletal and euhedral olivine crystals.
- E 18405 Porphyritic peridotite : note rim of expelled magnetite fringing each serpentinized olivine.
- F 18403 Basal zone : serpentinized olivine peridotite.

appear to originate from a point nucleus and grow wider as they grow away from the nucleus, resulting in an ostrich plume appearance for the crystal. Unlike dendritic olivine the plumose crystals have a constant orientation with the specimen and are a facing structure with the nucleus uppermost.

Amygdales are numerous in the rock but usually quite small, from 1 mm to 3 mm being the common size although rare examples up to 1 cm across may be found. The amygdales are usually spherical to subspherical but often show irregular extensions (Fig. 38, B). The amygdales contain a variety of minerals, principally a very fine-grained colourless or pale green, nearly isotropic, chloritic material and a little calcite, but often with a few small octahedra of magnetite and sheaves of tremolite. The minerals are sometimes arranged irregularly within the amygdale but are usually in a zonal arrangement with a rim of magnetite grains along the amygdale margin. A further feature of the amygdales is that they have a "tail" of pyroxene-rich material several times the size of the amygdale (Fig. 38, A and B) which consists of acicular clinopyroxene and glass without any olivine. Opposite

the tail, where the amygdale is in contact with the olivine-rich peridotite, the serpentinization of the olivine is always complete and the serpentine is particularly strongly dusted with magnetite. The tails of the amygdales are aligned with one another and give a further facing texture with the tail pointing downward. This is shown in Figure 38, A where a poor example of plumose olivine occurs a little to the right of the amygdale. The pyroxene-rich tail and the iron-rich halo of the amygdales are responsible for the bumps and pits on the weathered rock, the halo is resistant to weathering and forms a bump on the upper surface of a specimen while the tail, and the amygdale contents, are less resistant and form pits on the undersurface.

CHEMISTRY

The chemical characteristics of the Murphy Well rocks are presented in Tables 16 and 17, with analyses of comparable rock from other localities in Table 18. Electron probe analyses of mineral phases and interstitial glass from the Murphy Well ultramafite are given in Table 19.

TABLE 16. ANALYSES OF THE PERIDOTITE LAVA FROM MURPHY WELL

Sample No.	1	2	3	4	5	6	7	8	9	10
	18401	18402	18403	18404	18405	18406	18407	18408	18409	26652
SiO ₂	41.0	39.7	40.2	39.8	40.8	40.5	40.4	40.3	40.4	40.56
Al ₂ O ₃	2.5	2.2	4.2	4.5	5.0	4.4	4.9	5.0	4.7	4.58
Fe ₂ O ₃	5.1	9.1	4.7	4.8	5.8	5.2	5.7	5.7	6.4	5.05
FeO	1.03	0.64	4.07	4.01	4.23	4.21	4.04	4.03	3.27	4.34
MgO	34.5	33.2	32.3	31.7	30.0	32.1	30.4	29.2	31.3	31.50
CaO	0.24	0.11	3.85	3.98	4.26	4.33	4.37	4.82	4.11	3.85
Na ₂ O	0.05	0.10	0.25	0.17	0.20	0.05	0.08
K ₂ O	0.10	0.12
H ₂ O ⁺	12.84	11.73	8.99	9.30	9.39	8.55	9.12	8.78	9.60	8.71
H ₂ O ⁻	1.41	2.27	0.15	0.13	0.36	0.30	0.35	0.34	0.60	0.49
CO ₂	0.10	0.26	0.13	0.10	0.14	0.21
TiO ₂	0.11	0.10	0.19	0.21	0.23	0.21	0.23	0.24	0.22	0.24
P ₂ O ₅	0.02	0.20	0.05	0.30	0.03	0.01	0.03	0.04
MnO	0.09	0.16	0.17	0.16	0.17	0.18	0.18	0.18	0.18	0.14
Total	98.9	99.1	98.9	99.0	100.6	100.5	99.9	98.8	100.9	99.71
Trace Elements (ppm)										
Co	120	160	130	130	120	120	120	120	130	260
Cr	1630	1560	1730	1670	1800	1690	1690	1670	1680	1642
Cu	100	35	55	40	55	45	60	60	45	200
Ni	2900	2800	1900	1900	1700	1900	1700	1700	1900	2100
S	420	310	260	260	280	280	280	320	180	400
V	50	70	110	120	120	110	120	120	90	190

Analysts: Govt. Chemical Laboratories, 1-9: N. Marsh by X. R. F. except FeO, alkalis, CO₂ and H₂O 10: J. R. Gamble (chemical methods). Trace elements: atomic absorption. 1,2: Totally serpentinized olivine peridotite of basal zone; 3,4: 'Porphyritic' peridotite; 5,6: Peridotite of transition zone; 7-10: Amygdaloidal peridotite.

TABLE 17. ANALYSES OF MURPHY WELL LAVA RECALCULATED ANHYDROUS

	1	2	3	4	5	6	7	8	9	10
SiO ₂	47.9	46.2	44.2	44.1	45.2	44.5	44.6	44.4	45.1	44.8
Al ₂ O ₃	2.9	2.6	4.6	5.0	5.5	4.8	5.4	5.5	5.2	5.1
Fe ₂ O ₃	2.0	2.0	2.0	2.0	2.0	2.0	2.0	2.0	2.0	2.0
FeO	4.75	3.46	7.33	7.42	8.68	7.97	8.33	8.28	8.23	7.80
MgO	40.3	38.6	35.5	35.1	33.2	35.3	33.6	32.2	34.9	34.8
CaO	0.23	0.30	4.24	4.41	4.72	4.76	4.83	5.31	4.58	4.03
Na ₂ O	0.05	0.11	0.28	0.18	0.22	0.05	0.09
K ₂ O	0.10	0.10
TiO ₂	0.13	0.11	0.21	0.23	0.25	0.23	0.25	0.26	0.24	0.26
P ₂ O ₅	0.02	0.02	0.05	0.03	0.03	0.01	0.03	0.04
MnO	0.10	0.19	0.19	0.18	0.19	0.20	0.20	0.20	0.20	0.15

C.I.P.W. Norm

Q	0.00	0.00	0.00	0.00	0.00	0.00	0.00	0.00	0.00	0.00
C	2.39	2.05	0.00	0.00	0.00	0.00	0.00	0.00	0.00	0.00
Or	0.00	0.00	0.00	0.00	0.59	0.00	0.00	0.00	0.00	0.59
Ab	0.00	0.00	0.42	0.93	2.37	1.52	1.86	0.42	0.00	0.76
An	1.39	1.49	12.33	13.15	13.46	12.29	13.75	14.78	14.19	13.22
Di	0.00	0.00	6.77	6.78	7.63	8.79	7.92	9.10	6.59	5.14
Wo	0.00	0.00	3.58	3.59	4.02	4.65	4.18	4.80	3.48	2.72
En	0.00	0.00	2.81	2.81	3.07	3.61	3.22	3.68	2.69	2.12
Fs	0.00	0.00	0.38	0.38	0.53	0.53	0.52	0.62	0.42	0.31
Hy	53.19	46.86	22.91	21.07	21.74	18.20	20.75	23.99	24.80	25.12
En	49.70	40.88	20.21	18.54	18.55	15.86	17.85	20.54	21.46	21.95
Fs	3.49	5.98	2.70	2.53	3.19	2.34	2.90	3.46	3.34	3.17
Ol	38.24	44.95	52.57	53.26	50.90	55.76	51.74	46.50	51.52	50.85
Fo	35.50	38.72	45.82	46.29	42.79	47.96	43.88	39.23	43.98	43.86
Fa	2.74	6.24	6.75	6.96	8.11	7.80	7.86	7.27	7.54	6.98
Mt	2.90	2.90	2.90	2.90	2.90	2.90	2.90	2.90	2.90	2.90
Il	0.25	0.21	0.40	0.44	0.47	0.44	0.47	0.49	0.46	0.49
Ap	0.00	0.00	0.05	0.05	0.12	0.07	0.07	0.02	0.07	0.09

NOTE: Sample numbers as for Table 16. Fe₂O₃ has been reduced arbitrarily to 2 per cent, for explanation see text.

The most striking feature of the analyses is the uniformity of rocks from the porphyritic, transitional and amygdaloidal zones of the flow. Within the limits of the analytical method it would appear that the rocks crystallized from a magma of uniform composition. The high degree of serpentinization makes interpretation of analyses of the basal zone of the flow difficult. Two analyses (Table 16, Columns 1, 2) are given and the degree of serpentinization is indicated by the high H₂O⁺ values. The preservation of original textures in 18402, as in other rocks from this area, indicates that serpentinization was a constant volume process but the presence of plentiful pseudomorphs of pyroxene suggests that the rock contained much more CaO than the 0.11 per cent measured. Thayer (1966) argues that MgO, CaO, FeO and SiO₂ are expelled during constant volume serpentinization but the analyses would suggest that only CaO and Al₂O₃ have suffered any marked loss and that FeO has been oxidized to Fe₂O₃ but remained within the system. These data partially support Page (1967) who argues that CaO is removed in greater proportion than MgO. Serpentinization makes interpretation of these analyses difficult and recalculation on an anhydrous basis, as presented in Table 17, is strictly speaking not valid as an indicator of the original composition of the rock.

The chemical characteristics of the less altered bulk of the Murphy Well flow (Table 16, Columns 3-10) are similar to rocks from Marshall Pool and Scotia in Western Australia and Dundonald in Canada (Table 18, Columns 1, 2, 4, 6, 7) in having a higher calcium and aluminium content than the average peridotite (Table 18, Column 13) but lower than that of typical picrites. Unlike the peridotitic "komatiites" of Viljoen and Viljoen (1969a) (Table 18, Columns 8-10 this paper) the alumina content is high and the CaO/Al₂O₃ ratio is consistently less than unity, ranging from 0.8 to 0.99. Similarly the variation of these elements within a body, from low values at the base to higher values at the top, together with the variation in modal minerals, is used by Viljoen and Viljoen (1969a) and Nesbitt (1971) to demonstrate differentiation and the concentration of a pyroxene-rich liquid towards the top of the flow. At Murphy Well the concentration of calcium and aluminium is sensibly constant throughout the major part of the flow and is in conformity with the modal analyses (Table 15) which indicate a lack of differentiation. The closest comparison between the Murphy Well lava and peridotites at Scotia and in South Africa appears to be with the central portions of the bodies; in other words it corresponds with the average peridotite at these localities and has crystallized without differentiation.

TABLE 18. REPRESENTATIVE ANALYSES OF PERIDOTITES AND PICRITES

	1	2	3	4	5	6	7	8	9	10	11	12	13	14
SiO ₂	40.08	41.42	43.70	42.10	38.40	41.20	41.00	40.36	42.06	41.58	40.02	43.00	43.54	44.82
Al ₂ O ₃	4.70	5.33	6.10	4.35	2.80	4.90	4.90	1.97	2.21	3.44	4.39	4.64	3.99	10.29
Fe ₂ O ₃	5.19	4.79	2.94	4.45	4.83	12.10	10.70	5.84	4.73	5.20	3.50	2.42	2.51	1.88
FeO	4.22	4.27	5.27	5.69	3.17	12.10	10.70	3.75	5.23	6.01	3.81	6.47	9.84	8.98
MgO	30.50	29.70	27.85	30.77	38.78	28.00	28.50	35.17	29.93	26.71	33.82	33.45	34.02	22.07
CaO	4.16	4.89	6.25	3.74	1.52	4.50	2.80	3.45	5.18	5.99	2.75	3.99	3.46	8.08
Na ₂ O	0.12	0.16	0.19	0.17	0.10	0.05	0.16	0.12	0.21	0.25	0.56	0.94
K ₂ O	0.10	0.07	0.02	0.03	0.06	0.00	0.02	0.03	0.05	0.05	0.25	0.10
H ₂ O ⁺	7.66	7.77	6.92	8.48	10.10	8.42	12.74	7.76	8.62	9.03	10.10	3.83	0.76	1.41
H ₂ O ⁻	0.31	0.17	0.21	0.15	0.18	0.51	1.22	0.92
TiO ₂	0.29	0.31	0.28	0.18	0.14	0.29	0.32	0.41	0.31	0.38	0.20	0.18	0.81	0.78
P ₂ O ₅	0.02	0.00	0.00	0.05	0.12
Cr ₂ O ₃	0.40	0.40	0.58	0.31	0.31	0.30	0.32	0.51
MnO	0.10	0.11	0.20	0.20	0.15	0.15	0.10	0.16	0.19	0.08	0.15	0.21	0.11
NiO	0.30	0.30	0.17	0.29	0.25	0.18	0.15	0.00
Total	98.13	99.79	99.72	100.16	100.05	100.34	100.69	99.63	99.76	99.70	99.88	99.68	100.00	100.08

1. Vesicular peridotite, Marshall Pool, W.A. (McCall and Leishman, 1971)
2. Peridotite, Marshall Pool, W.A. (McCall and Leishman, 1971)
3. Plate spinifex peridotite, Scotia, W.A. (Nesbitt, 1971)
4. Olivine peridotite, Scotia, W.A. (Nesbitt, 1971)
5. Harrisitic olivine peridotite, Scotia, W.A. (Nesbitt, 1971)
6. Peridotite (SA37), Dundonald, Ontario (Naldrett and Mason, 1968)
7. Peridotite (SA412), Dundonald, Ontario (Naldrett and Mason, 1968)
8. VU32A, olivine peridotite, base of flow, Barberton, South Africa (Viljoen and Viljoen, 1969a)
9. V2, peridotite, centre of flow, Barberton, South Africa (Viljoen and Viljoen, 1969a)
10. AUB, pillowed peridotite, top of flow, Barberton, South Africa (Viljoen and Viljoen, 1969a)
11. Serpentinized peridotite, Lizard, Cornwall, U.K. (Green, 1964)
12. Vitrophyric peridotite, pillow lava, Cyprus (Gass, 1958)
13. Average peridotite (23 analyses) (Nockolds, 1954)
14. Picrite sheet, Ubekendt Eiland, Greenland (total includes 0.15 per cent CO₂) (Drever, 1956)

TABLE 19. ELECTRON PROBE ANALYSES OF MINERAL PHASES (AVERAGE OF TWO SPOT ANALYSES)

	18403			13404			26652		
	OI	Cpx	Glass	OI	Cpx	Glass	OI	Cpx	Glass
SiO ₂	41.2	47.5	35.5	39.3	46.4	35.8	40.0	48.4	35.5
Al ₂ O ₃	0.1	6.5	10.1	0.2	6.6	9.1	0.0	5.1	9.1
FeO	6.5	7.3	4.6	6.6	6.8	5.0	8.6	8.3	4.0
MgO	53.3	13.1	33.3	49.9	13.4	33.2	47.8	14.7	31.1
CaO	0.0	22.4	1.1	0.0	22.0	1.6	0.0	18.7	0.8
NiO	0.42	0.02	0.14	0.20	0.0	0.12	0.49	n.d.	0.10
Cr ₂ O ₃	n.d.	n.d.	n.d.	n.d.	n.d.	n.d.	n.d.	0.67	n.d.
Total	101.52	97.02	84.74	96.20	95.2	84.82	96.89	95.87	80.60
Si	0.97	1.80	0.99	1.86	1.01	1.93
Al	0.20	0.14	0.07
Al	0.09	0.02	0.05
Fe	0.13	0.24	2.00	0.14	0.23	2.00	0.18	0.28	2.00
Mg	1.90	0.77	1.87	0.80	1.81	0.87
Ca	0.90	0.95	0.80
Atomic Ratios									
Mg	93.1	39.6	92.8	40.8	90.5	44.8
Fe	6.9	12.2	7.2	11.5	9.5	14.2
Ca	48.2	47.7	41.0

Outside the major Archaean terrains comparable analyses have been obtained for the high-temperature peridotite of the Lizard area, Cornwall, U.K., intruded during the Hercynian Orogeny (Green, 1954) and the possibly Triassic ultrabasic pillow lavas of Cyprus (Gass, 1958). Representative analyses of these rocks are included in Table 18.

Table 17 gives the analyses of the Murphy Well ultramafite recalculated anhydrous and with all except 2 per cent of the Fe_2O_3 recalculated to FeO . The justification for this is that much of the ferric oxide present is due to the post-crystallization serpentinization of the olivine and adversely affects the olivine/pyroxene ratio of the norm. The resulting analysis is thought to represent fairly reliably the original magma as it would appear from the textures and that part of the original mineralogy preserved that chemical losses from the system due to serpentinization are only minor. Iron expelled from serpentinized olivine is concentrated along the margin of the crystal as partially oxidized magnetite and the original interstitial glass is devitrified rather than recrystallized. Both factors indicate that the movement of ions has been of local significance only and this is supported by the electron probe analyses of the glass (Table 19) and the electron probe scan across a relict olivine grain in Figure 40. These criteria do not apply to the analyses of the basal peridotite which is totally serpentinized and has lost most of its calcium and probably some iron and aluminium as well.

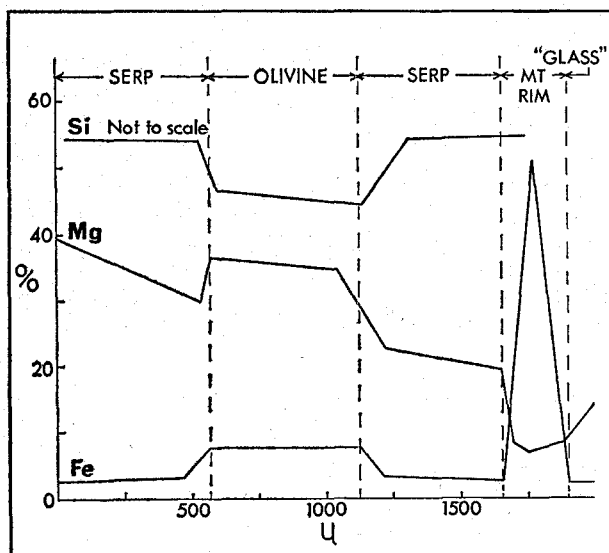

Figure 40. Electron probe scan across relict olivine grain in 26652 (analyst: J. Hallberg, C.S.I.R.O.).

If analyses 3 to 10 of Table 17 represent the original magma then the rock normatively was an ultrabasic olivine-rich peridotite with almost twice as much olivine as pyroxene. The pyroxene of the norm is predominantly orthopyroxene, a feature noted from the norms of both Canadian and South African examples. While some orthopyroxene was noted in the overlying lenses of ultramafics at Dundonald township, Ontario (Naldrett and Mason, 1968) none is seen in the rocks from Murphy Well or the ultramafic lavas from Munro township, Ontario (Pyke and others, in press). This is accounted for by the highly aluminous nature of the modal clinopyroxene which results in the calcium being used to convert hypersthene to augite rather than forming anorthite (Pyke and others, in press). Similarly the normative plagioclase present varies from 13 to 16 per cent while none is observed in the mode, in fact the calcium and aluminium are present as clinopyroxene rather than anorthite.

Electron probe data in the mineral phases present in the Murphy Well peridotite are presented in Table 19. Olivine, pyroxene and devitrified glass were probed in each of three specimens

where preservation was considered good. The olivine is highly magnesian and varies from $\text{FO}_{90.5}$ to $\text{FO}_{93.1}$. This is more forsteritic than the usual olivine from basic rocks and most peridotites but is the range commonly found in Archaean peridotites, although in the overlying lenses at Dundonald the olivine ranges only from $\text{FO}_{85.90}$ (Naldrett and Mason, 1968). Although there is an apparent rise in the fayalite content of the olivine towards the top of the Murphy Well flow insufficient data are available to determine whether this is other than experimental variation, or, perhaps, zoning within the olivine crystals (see Pyke and others, in press). The clinopyroxene of the Murphy Well ultramafite is high in both calcium and aluminium and is diopsidic. The iron content of the pyroxene in 18403 and 18404 brings it into the salite field of Poldervaart and Hess (1951) while a decrease in the calcium brings 26652 into the augite field. High alumina clinopyroxenes are becoming a commonly recognized feature of Archaean peridotites (Nesbitt, 1971; Pyke and others, in press) and owing to the mode of emplacement of these bodies cannot be considered a feature of high-pressure crystallization as suggested by Green (in Wyllie, 1967).

The significance of the analyses of devitrified glass from the Murphy Well ultramafite is problematical. The glass is rich in alumina and magnesia but poor in silicon and calcium. The analyses, despite their internal agreement, never total more than 85 per cent and it is possible that the remainder is largely H_2O^+ . Serpentinization of adjacent olivine has possibly distorted the analyses from the original composition of the glass. Figure 38 suggests that magnesia is released from the olivine by serpentinization and silica is increased, possibly by extraction from the glass. Aluminium and calcium however are not involved in the process of serpentinization and are possibly near their original levels. The present mineralogy of the devitrified glass is possibly a highly magnesian chlorite. The overall composition of the glass, even with allowance for transfer of ions does not suggest a particularly silica-enriched residual fraction and is richer in magnesium and poorer in calcium than those reported by Nesbitt (1971).

DISCUSSION

ULTRAMAFIC MAGMAS

The possibility of a true ultrabasic magma was dismissed by Bowen (1928, p. 166) both on theoretical grounds due to the very high temperatures required to produce a peridotite liquid and on the practical grounds that no ultrabasic rocks were known that were aphanitic or had a glassy ground mass. Instead Bowen proposed that all ultrabasic rocks were formed by the intrusion of a crystal mush consisting of cumulate olivine crystals and a small proportion of basaltic liquid to act as a "lubricant". Bailey and McCallien (1953), to reconcile certain field evidence from serpentinite bodies near Ankara, Turkey, proposed the existence of a serpentine magma which could be extruded as lava flows. More recently Taylor (in Wyllie, 1967) has proposed the intrusion of an ultrabasic magma to explain certain complexes of Cretaceous or Tertiary age in southeast Alaska. The conflict between the experimental and the field evidence—the "Magnificent Argument" has been reviewed by Wyllie (1967) but at the time the evidence of Archaean ultramafic bodies like the Murphy Well peridotite was not available. Viljoen and Viljoen (1969a) have also reviewed recent experimental data and have reconciled it with their evidence of extrusive peridotites in the Barberton region of South Africa.

Recognition that the spinifex texture found at the margins of many Archaean peridotites represents a quench texture and the presence of devitrified glass in these peridotites (Naldrett and Mason, 1963; Viljoen and Viljoen, 1969a; Lewis, 1971; Nesbitt, 1971) removes the practical objections that Bowen had to an ultrabasic magma.

In comparison with other ultramafic flows the Murphy Well ultramafite shows both similarities and differences. The chemical characteristics of

the flow have been commented on earlier and the textural similarity of the porphyritic zone to the central zones in other Achaean ultramafites is well marked. Differences include the thickness of the unit which is greatly in excess of that reported from the ultramafic flows in South Africa (Viljoen and Viljoen, 1969a), Canada (Pyke and others, in press) and near Mount Clifford, W.A. (Barnes, 1972, pers. comm.), the preservation of an amygdaloidal flow top which has not been reported before, although certain rocks at Marshall Pool appear to be similar (McCall and Leishman, 1971), the dendritic nature of the olivine in the flow top and the apparent lack of differentiation within the body.

In all other reports ultramafic flows are thin, from 12 m to 30 m in the Barberton Mountain land, South Africa, from 1 m to 17 m in Munro township, Canada and from 5 m to 15 m at Mount Clifford, W.A. The Murphy Well lava has a thickness of 162 m and although poor exposure may conceal flow divisions within the body no indication of this was found either in the field or in petrographic studies.

The nature of the magma envisaged by most authors for ultramafic flows and near surface sills is similar. A magma is proposed with a liquid fraction, capable of crystallizing a pyroxene peridotite, in which olivine crystals are suspended. Viljoen and Viljoen (1969a, p. 98) draw attention to the small effect that gravitative settling will have on small olivine crystals in a rapidly crystallizing mass and all authors invoke the flow differentiation described by Bhattacharji (in Wyllie, 1967) to account for the quench crystallization of a nuclei-free upper spinifex layer containing about 40 per cent olivine and lower layers containing up to 80 per cent euhedral olivine crystals. In the Murphy Well ultramafite, however, modal analyses (Table 15) show a constant 60 per cent olivine throughout the bulk of the unit only rising to 70 per cent in the basal few metres. Chemical analyses (Table 16) also indicate a lack of differentiation. In addition, even in those flows where differentiation is demonstrable a proportion of the euhedral olivine must have crystallized directly from the interstitial liquid after extrusion.

The crystallization of olivine under conditions of rapid cooling have been studied by Drever and Johnston (1957) and their work on skeletal olivine has been extended by Lewis (1971) and Nesbitt (1971) to demonstrate that spinifex texture is the result of quenching of a nuclei-free ultrabasic liquid. Lewis (1971) observed that no analogue of the dendritic fayalite seen in slags had been encountered in nature but the Murphy Well lava does contain similar dendritic crystals in the amygdaloidal flow top. That these delicate crystals formed directly from a quenched liquid cannot be doubted but why in this instance small scale dendritic crystals should form throughout a thickness of 21 m rather than large plates of spinifex textured olivine is not clear. Possible explanations include the presence of amygdales, the surface of which could have generated sufficient nuclei to crystallize the liquid simultaneously throughout the thickness of the flow top or the lack of any flow differentiation which could have cleared nuclei from this portion of the flow. Although nuclei were obviously plentiful no porphyritic olivines are observed in the flow top. It is not necessary, with the Murphy Well peridotite, to postulate superheating of the liquid to remove nuclei as proposed by Nesbitt (1971) in his discussion of the formation of spinifex texture. A further difference between the dendritic texture of the Murphy Well peridotite and spinifex texture is its non-directional nature. Spinifex texture is directional with the long axes of the olivine plates perpendicular to the cooling surface whereas the dendritic olivines of the Murphy Well rocks have crystallized from a multitude of internal nuclei and are randomly oriented. Directional crystallization is observed at Murphy Well but the plumose olivines are very subordinate to the dendritic.

The uniformity of chemical composition of the Murphy Well ultramafite and the undoubted liquid nature of the amygdaloidal flow top leads to the

question of the origin of the euhedral olivine crystals of the bulk of the flow. Any form of differentiation is ruled out and the rise of gas bubbles would have the effect of homogenizing the magma after extrusion. We are drawn to the conclusion, therefore, that the magma of the central portions of the flow was similar to that at the top, i.e. a liquid with no phenocrysts but with many sub-microscopic nuclei. Most authors have considered the euhedral olivine to be phenocrysts and present at the time the magma was extruded. This view is stated clearly by Naldrett and Mason (1968, p. 124) who "... suggest that the mineral was crystallized in two very different environments. The equant grains are characteristic of olivine cumulates the world over ... (and) ... crystallized under normal conditions of relatively slow cooling". Unless it is suggested that the liquid portion was itself differentiated we must conclude that the Murphy Well magma was extruded as a crystal-free liquid and that the crystal habit of olivine is extremely sensitive to very small variations in physical conditions and rate of cooling at the point of crystallization. This is essentially the conclusion reached by Drever and Johnston (1957, p. 310).

TEMPERATURE OF EXTRUSION OF ULTRAMAFIC LAVAS

No direct observations have been made on the temperature of extrusion of ultramafic lavas but Viljoen and Viljoen (1969a) after an examination of recent experimental work suggest a temperature of about 1,400°C, not too far above the known temperatures of basaltic magmas. Häkli and Wright (1967) have demonstrated that the fractionation of nickel between augite and olivine is a reliable geothermometer for Hawaiian olivine basalts and it is possible that this method could give a direct value of the crystallization temperature of ultramafic rocks in which the original mineralogy is preserved. The data presented in Table 19 are insufficient and use of the graphs of Häkli and Wright gives no consistent figure but the lowest value obtained is approximately 1,400°C using the olivine/pyroxene ratio from 18403 and the authors suggest this might be a method worth further investigation.

AMYGDALES

The amygdales in the upper 21 m of the Murphy Well lava provide an exceptional point of interest due to their excellent state of preservation (Fig. 38, A and B). Their general characteristics have been described above and they will be reconsidered here for the evidence they give on the crystallization of the magma. Similar poorly preserved amygdales have been described from Marshall Pool, W.A. (McCall and Leishman, 1971) but from pyroxene-rich peridotites.

The authors interpret the tail of pyroxene-rich material as being residual liquid that flowed into the path cleared by the rising gas bubble through a forest of rapidly growing dendritic olivine crystals. No obvious tail could form until the olivine crystals were sufficiently well developed not to move in behind the rising bubble and the whole process stopped when the olivine dendrites were sufficiently well formed to physically hold back the bubble. This whole stage took place very rapidly as the longest tail is only about three times the bubble diameter, and small bubbles have poorly developed tails. That the residual liquid at this stage was very fluid is shown not only by the presence of a pyroxene-rich tail but by the flame structures developed at the top of many amygdales which are interpreted as the escape upward of smaller bubbles after the larger bubble had been trapped. This interpretation is supported by the amygdale figured in Figure 38, B which is seen to have two radii of curvature with a narrow arc of magnetite octahedra within the pyroxene tail which continues the upper surface of the amygdale. It is suggested that a short while after the amygdale had been arrested by the olivine dendrites it was able to partially escape upward and as more residual liquid filled the space behind it left the arc of magnetite as an indicator of its former position. Following this reasoning the halo of complete serpentinization that surrounds each amygdale is

thought to be due to the post-crystallization escape of the amygdale fluids into the surrounding peridotite.

If this interpretation of the amygdales is accepted then it will be seen that the olivine in the rock crystallized from a low viscosity liquid although the devitrification of glass can produce textures with a large degree of similarity (Rodgers, 1970).

Although vesicles from ultramafic rocks have not been studied before, Smith (1967) has studied segregation vesicles in basalt which show certain similarities. Smith interprets these vesicles as having contracted during cooling with the resultant entry of interstitial residual liquid into the vesicle. In this way the principal surface of the vesicle remains ellipsoidal but the remaining vesicle is highly irregular in shape, is entirely surrounded by glass and is often split into several smaller irregular vesicles. This interpretation is not possible for the amygdales of the Murphy Well peridotite as they are usually spherical in shape, show no change of shape due to intruding liquid and on the contrary often show apophyses which indicate an excess pressure in the amygdale rather than insufficient pressure to maintain its shape. Upton and Wadsworth (1971) use Smith's mechanism to explain rhyodacite tails to vesicles in a basalt from Reunion. It is noted that the tails are directional and that the spherical gas bubble occupies the upper part of the vesicle. From the published illustrations (Upton and Wadsworth, 1971, Figs. 1 and 3) it would appear that the tails formed during the upward passage of the vesicle in a manner similar to that described for the Murphy Well ultramafite rather than by infilling of a larger vesicle.

SERPENTINIZATION

As seen in Table 15, the Murphy Well rocks, except for the basal layer, are partially serpentinized peridotites containing 45 to 53 per cent serpentine. The serpentine is all formed by the partial replacement of olivine. Thayer (1966) has argued that serpentinization is a constant volume process that involves significant losses of certain elements, while Viljoen and Viljoen (1969b) have shown that at low levels of serpentinization (H_2O^+ content of rock less than 10 per cent) there is little change in the chemistry of the rock. The preservation of original textures in such perfect detail in the Murphy Well rocks certainly agrees with Thayer's main thesis but it has been shown already that the elements displaced by serpentinization do not leave the system but are located either as a magnetite rim to the pseudomorph or in the devitrified glass. The origin of the water necessary for serpentinization must also be considered. It is generally accepted (Wyllie, 1967) that a peridotitic melt would contain little water and Martin (1971) suggests that serpentine is unstable above 200°C except at very high water vapour pressures. The serpentinization of a surface flow, therefore, is possibly a weathering feature but this would be accompanied by considerable expansion. The amygdaloidal nature of the Murphy Well ultramafite, however, indicates that the magma must have been supersaturated in volatiles which separated very rapidly under low pressure conditions. It is possible that under these circumstances the melt cooled sufficiently rapidly to trap much of the volatile component in the glassy matrix. Serpentinization is then possible by a transfer at low temperatures of components within the rock, so obviating problems of volume change or element loss.

ACKNOWLEDGMENTS

The authors wish to acknowledge helpful discussion with Dr. D. R. Hudson and Dr. J. A. Hallberg and assistance with electron probe analysis by Mr. R. B. W. Vigers, all of C.S.I.R.O. Mineralogical Laboratories, Perth.

REFERENCES

- Balley, Sir E. B., and McCallien, W. J., 1953, Serpentine Lavas, the Ankara Melange and the Anatolian Thrust: Roy. Soc. Edinburgh Trans., v. 62, p. 403-442.
- Bowen, N. L., 1928, The Evolution of the Igneous Rocks: Dover (New York).
- Drever, H. I., 1956, The Geology of Ubekendt Ejland, West Greenland: II—The Picritic sheets and dykes of the east coast: Med om Grønland, v. 137, no. 4, p. 1-39.
- Drever, H. I., and Johnston, R., 1957, Crystal growth of forsteritic olivine in magmas and melts: Roy. Soc. Edinburgh Trans., v. 63, p. 289-315.
- Gass, I. G., 1958, Ultrabasic pillow lavas from Cyprus: Geol. Mag. v. 95, p. 241-251.
- Green, D. H., 1954, The petrogenesis of the high-temperature peridotite intrusion in the Lizard Area, Cornwall: Jour. Petrology, v. 5, p. 134-188.
- Häkli, T. A., and Wright, R. L., 1967, The fractionation of nickel between olivine and augite as a geothermometer: Geochim. et Cosmochim. Acta v. 31, p. 877-884.
- Lewis, J. D., 1971, "Spinifex Texture" in a slag, as evidence for its origin in rocks: West. Australia Geol. Survey Ann. Rept. 1970, p. 45-49.
- McCall, G. J. H., and Leishman, J., 1971, Clues to the origin of Archaean eugeosynclinal peridotites and the nature of serpentinization: Geol. Soc. Australia Special Publication no. 3, p. 281-299.
- Martin, B., 1971, Some comments on the processes of serpentinization from experimental and other work: Geol. Soc. Australia Special Publication no. 3, p. 301-310.
- Naldrett, A. J., and Mason, G. D., 1968, Contrasting Archaean ultramafic igneous bodies in Dundonald and Clergue townships, Ontario: Canadian Jour. of Earth Sciences, v. 5, p. 111-143.
- Nesbitt, R. W., 1971, Skeletal crystal forms in the ultramafic rocks of the Yilgarn Block, Western Australia; Evidence for an Archaean ultramafic liquid: Geol. Soc. Australia Special Publication no. 3, p. 331-347.
- Nockolds, S. R., 1954, Average chemical compositions of some igneous rocks: Geol. Soc. America Bull. v. 65, p. 1007-1032.
- Page, N. J., 1967, Serpentinization considered as a constant volume metasomatic process: A discussion: Am. Mineralogist v. 52, p. 545-549.
- Poldervaart, A., and Hess, H. H., 1951, Pyroxenes in the crystallization of basaltic magma: Jour. Geology, v. 59, p. 4-72.
- Pyke, D. R., Naldrett, A. J., and Eckstrand, O. R., in press, Archaean ultramafic flows in Munro township, Ontario: Geol. Soc. America Bull.
- Rodgers, P. S., 1970, The initiation of crystal growth in glasses: Mineralog. Mag. v. 37, p. 741-752.
- Saratovkin, D. D., 1959, Dendritic crystallization: Consultants Bureau Inc. (New York).
- Smith, R. E., 1967, Segregation vesicles in basaltic lava: Am. Jour. Sci., v. 265, p. 696-713.
- Thayer, T. P., 1966, Serpentinization considered as a constant volume metasomatic process: Am. Mineralogist, v. 51, p. 685-710.
- Upton, B. G. J., and Wadsworth, W. J., 1971, Rhyodacite glass in Reunion basalt: Mineralog. Mag. v. 38, p. 152-159.
- Viljoen, M. J., and Viljoen, R. P., 1969a, Evidence for the existence of a mobile extrusive peridotitic magma from the Komati Formation of the Onverwacht Group: Geol. Soc. South Africa Special Publication, v. 2, p. 87-112.
- Viljoen, R. P., and Viljoen, M. J., 1969b, The effects of metamorphism and serpentinization on the volcanic and associated rocks of the Barberton Region: Geol. Soc. South Africa Special Publication, v. 2, p. 29-53.
- Williams, I. R., Gower, C. F., and Thom R., 1971, Explanatory notes on the Edjudina 1:250,000 Geological Sheet: West. Australia Geol. Survey Rec. 1971/26 (unpublished).
- Wyllie, P. J., (Ed.), 1967, Ultramafic and related rocks: New York, John Wiley.

A GUIDE TO THE GEOCHEMISTRY OF NICKELIFEROUS GOSSANS AND RELATED ROCKS FROM THE EASTERN GOLDFIELDS

by R. H. A. Cochrane

ABSTRACT

A reconnaissance survey of gossans developed on areas of nickel sulphide mineralization was carried out during a geochemical orientation investigation in the Eastern Goldfields. One hundred and sixteen samples were collected from 23 localities including all the productive nickel mines. These samples were then analysed by Atomic Absorption Spectroscopy (A.A.S.) for copper, lead, zinc, nickel, cobalt, chromium, manganese, silver, molybdenum and iron.

The range of analytical results obtained from a typical unlateritized gossan derived from nickel sulphide mineralization are:

Cu	Pb	Zn	Ni	Co	Cr	Mn	Ag	Mo	Fe
500	less	less	1000	less	less	less	less	less	10%
to	than	than	to	than	than	than	than	than	to
5000	50	100	5000	1000	500	500	5	5	30%

All results expressed in parts per million (ppm) except for iron (Fe) which is shown as a percentage.

INTRODUCTION

During a geochemical orientation survey of the Eastern Goldfields in May 1972, most known locations of nickel sulphide mineralization were visited. This orientation survey was carried out to provide the necessary background information to determine the criteria for the existence of mineralized cells within the ultramafic rocks of the Leonora and Laverton 1:250,000 sheets, and whether these cells could be distinguished on a regional geochemical mapping scale. As gossans were present at many of these locations they were sampled and the results are presented here.

PHYSICAL BACKGROUND

PREVIOUS WORK

Little published work is available on the geochemistry of nickeliferous gossans in Western Australia. A recent paper by Mazzuchelli (1972) describes the geochemical environment of the Kambalda nickel deposit with particular respect to the soil geochemistry and its relation to bedrock and to the underlying ore deposits. A general description of the problem of the interpretation of leached outcrops is given by Blanchard (1968). His work is mostly related to copper, lead and zinc gossans from the eastern States of Australia and from North America, with no reference to nickel.

A great interest in nickel gossans was developed during the "nickel boom" of 1968-1970 in Western Australia. Consequently a large number of companies carried out many studies parallel to this one but as yet none of these results have been published.

LOCATION

The geographical location of samples range from Pioneer Siding in the south (40 km north of Norseman), north to Mount Keith (80 km south of Wiluna) with easterly and westerly sample limits at Mount Windarra (24 km west of Laverton) and Nepean (25 km south of Coolgardie) respectively. The locations are shown in Figure 41.

METHOD OF COLLECTION

All samples were collected by the writer and where possible involved collection in situ, on the surface, in costeans, shafts, winzes etc., when the outcrop still existed. Other samples were collected from larger display specimens "salvaged" by company geologists prior to mine development, or in some cases collection from company archives when the outcrop no longer existed. Where possible at least 250 g of each sample were collected.

All samples carry a G.S.W.A. number e.g. 35001, and refer to an individual specimen. Samples numbered e.g. 35737/A, 35737/B refer to pieces off the original sample 35737 and have been analysed separately.

DEFINITION OF TERMS AND DESCRIPTIONS OF PHYSICAL CHARACTERISTICS

To avoid repetition of terms the following definitions apply:

GOSSAN

A gossan is a moderately heavy accumulation of limonitic material, derived in the main from economic sulphide mineralization or from its iron-yielding gangue associates, which have been leached more or less in place, and normally overlie a mineralized zone beneath.

This definition includes the term *capping* as no distinction is made between material derived from massive and disseminated sulphides. A rock is not normally considered gossanous unless the limonite developed is appreciably porous or cellular and a substantial proportion of the limonite-yielding materials have been leached.

Nickel or nickeliferous gossan refers to gossanous material derived in the main from nickel sulphide mineralization.

Copper gossan means similar material derived in the main from copper sulphides.

False gossan. A false gossan is a moderately heavy accumulation of limonitic material derived from any source, other than economic mineralization, that exhibits the physical properties normally found in a gossan (*sensu stricto*). It includes gossanous material derived from non-economic sulphide mineralization, typically pyrite.

Laterite. A laterite is an accumulation of oxides of iron, aluminium and other related elements, developed in the arid environment as a resistate mineral assemblage during weathering. Lateritic material is characteristically more dense than gossanous material and is often magnetic.

It is not always practicable to apply exactly these rigorous definitions as most gossans are partially lateritized or silicified. Slightly silicified gossans are the most common and their structure is less cellular than may be expected, the samples often fracture conchoidally revealing well developed limonites after pentlandite and pyrrhotite.

TYPICAL DESCRIPTIONS

Gossan 35045/B (see Fig. 42, A) has very finely, irregularly mottled, light to dark patches of limonite and silica, common black oxides, occasional blood red patches and rare finely and irregularly interlaminated limonitic yellow to black blebs; voids are of minor significance and are often filled with chalcedonic silica. The surface is smooth with poorly developed conchoidal fractures with minor sharp ridges between fractures.

False gossan 35100 (see Fig. 42, B) shows a network of finely spaced, limonite-stained, quartz veins enclosing voids, some partly filled with limonite and black oxides. Voids constitute up to half a sample. The surface is rough with small jagged projections on the edges of the voids.

Laterite 35592 (see Fig. 42, C) is an open breccia of fragments of rock, part banded or otherwise layered and part structureless, containing various oxides of iron from hematite to limonite, generally subangular, roughly equidimensional in part cemented by metallic or submetallic cement. Minor limonite-lined intergranular voids are present. The surface is irregular with a poorly developed botryoidal texture. This sample is denser than those previously described and is slightly magnetic.

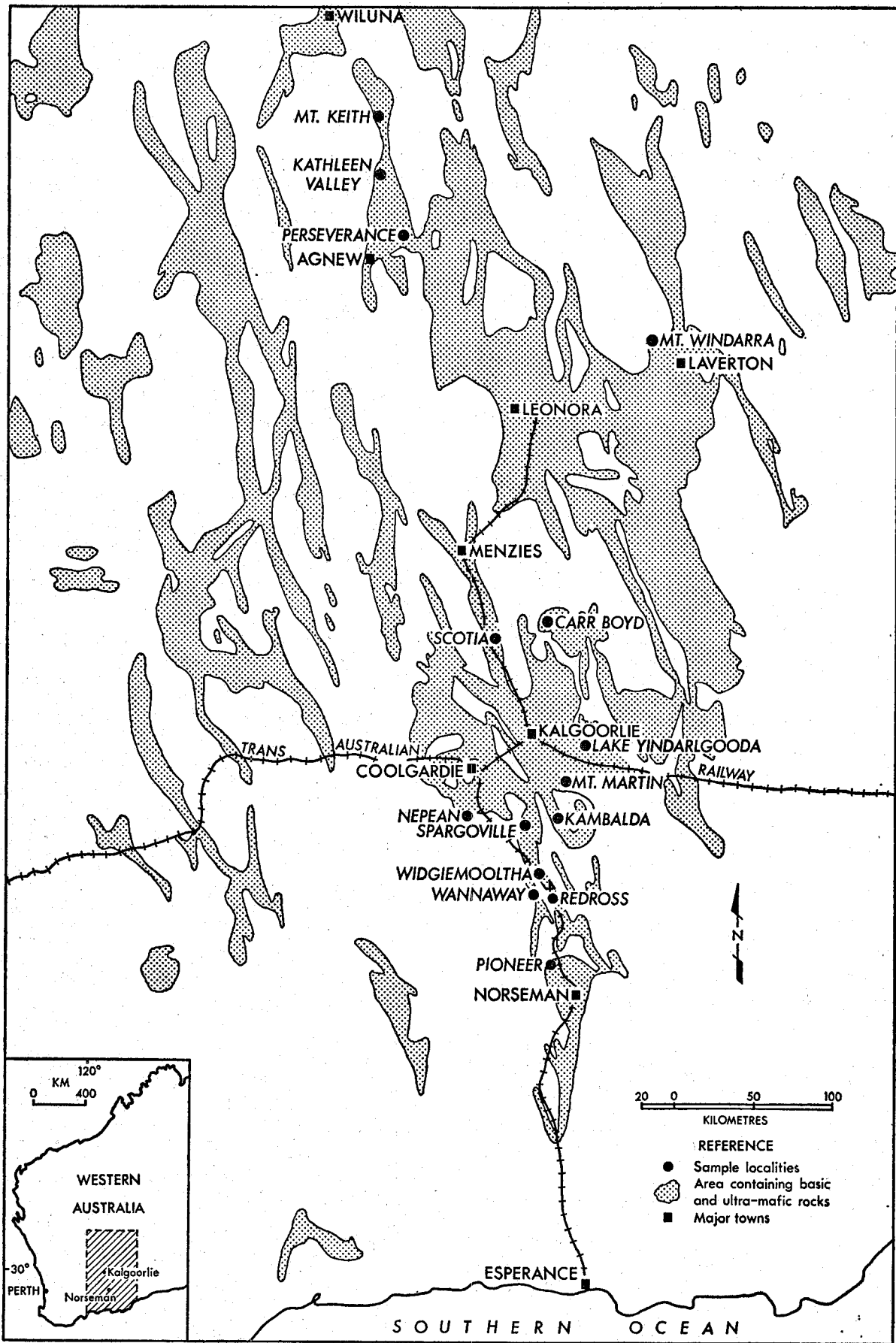

Figure 41. Western Australia—Eastern Goldfields with locations of nickel mineralization.

Figure 42 (opposite)

Photographs of a gossan, a false gossan and laterite

- A 35045/B A good example of a silicified nickel sulphide gossan, the mottled surface and minor voids are easily seen.
- B 35100 A false gossan derived from pyrite, note the large voids.
- C 35592 The cut and polished surface of a laterite with large and small ferruginous accumulations cemented together.

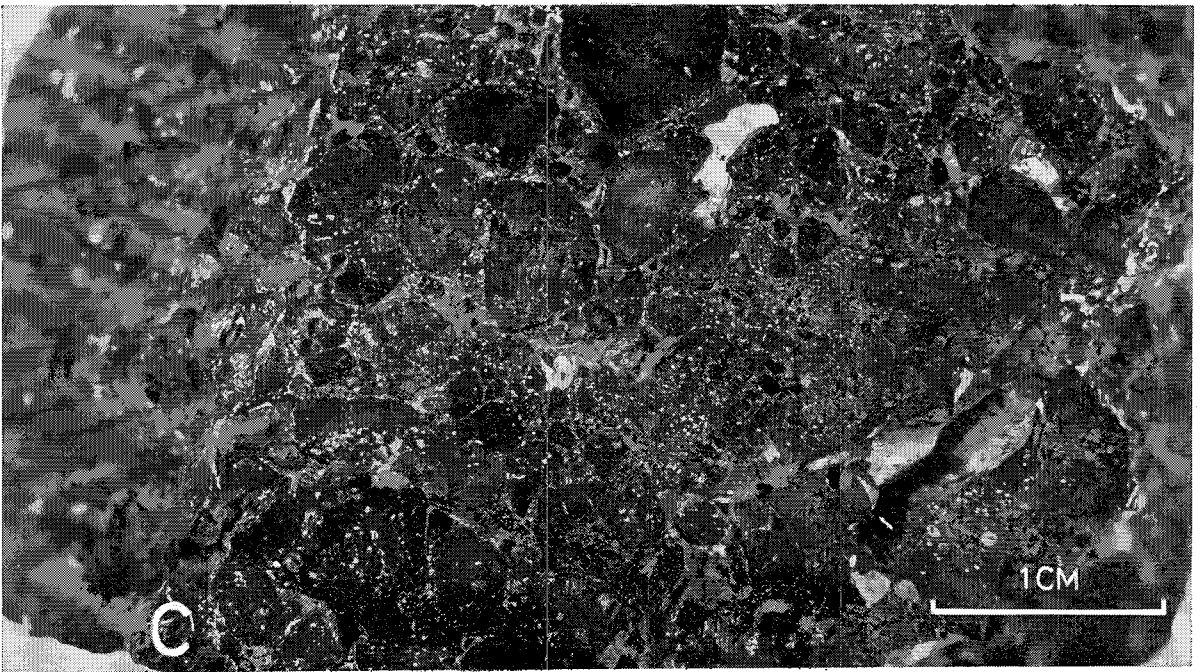
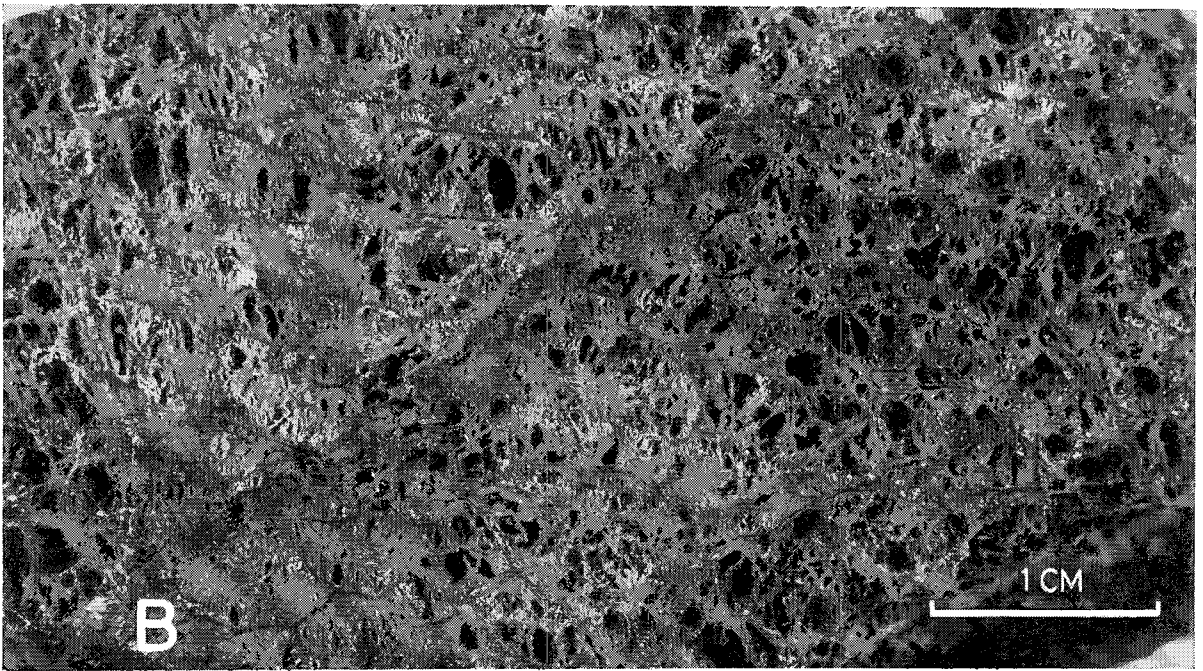
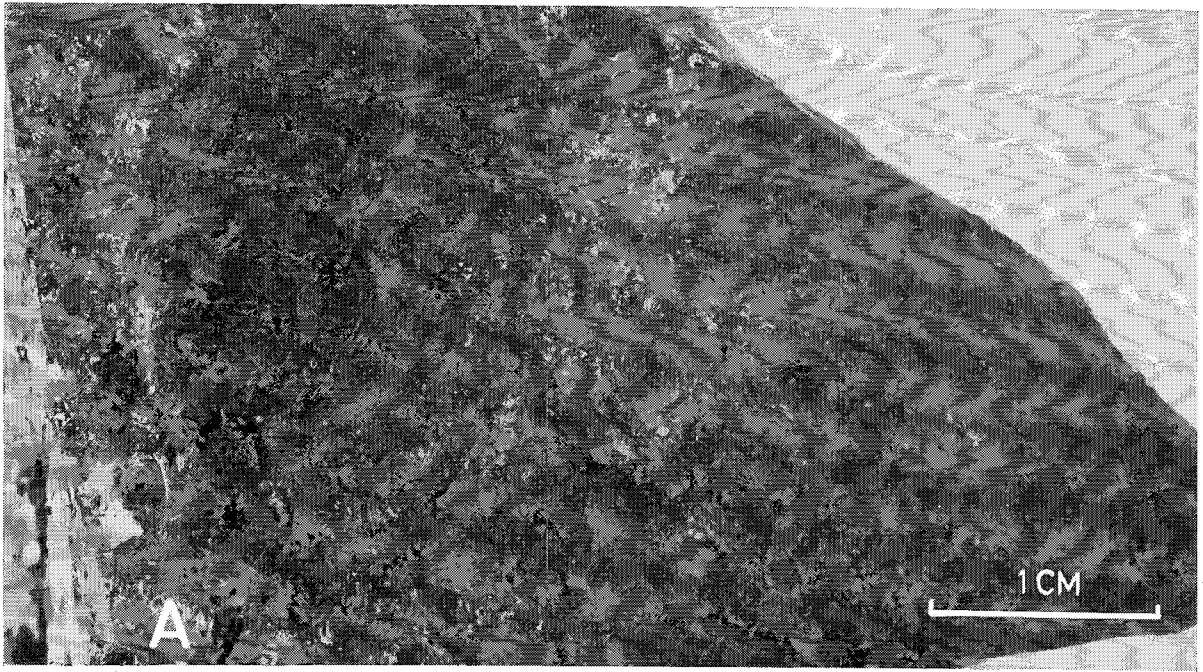

Figure 42

GEOCHEMISTRY

ANALYTICAL TECHNIQUE

The technique employed for analysis was conventional perchloric/nitric acid digestion with evaporation to dryness, followed by aspiration of the residue from a hydrochloric acid solution by Atomic Absorption Spectroscopy (A.A.S.).

Method

Weigh 1 g of ground sample (-200 μ) into a pyrex test tube (185 mm x 25 mm) add 20 mls of *premixed** concentrated perchloric/nitric acid (3 parts HClO₄ : 1 part HNO₃).

Place in an air bath and heat to approximately 100°C, allow to remain at this temperature for at least 1 hour. Continue heating until the solution reaches approximately 220°C. Keep at this temperature until it has fumed to dryness. This takes 6 to 8 hours. This time to dryness must be fairly constant if any correlation is to be attempted between chromium results of different batches of samples.

Add 5 ml of concentrated hydrochloric acid and heat on water bath at 100°C for 1 hour. Add 20 ml of distilled water, mix thoroughly and leave to stand overnight.

Determine by A.A.S. using hydrochloric acid (20 per cent) based standards and flame conditions appropriate to the element being determined.

Discussion

This method was chosen as one digestion gave results for a large number of elements with a reasonable degree of reproducibility, as well as being inexpensive in terms of materials and time. This method gives a good "total" value for all elements except chromium, and here if the time for fuming to dryness is kept constant, the results are reproducible. If "total" chromium results are available from another method, say X.R.F. (X-ray Fluorescence Spectroscopy), for similar samples it is possible to calculate an approximate correction factor to correlate A.A.S. and "total" results.

Other A.A.S. digestion methods such as the use of nitric acid and hydrochloric acids either together or alone, whether fumed to dryness or not, as well as the use of perchloric/nitric acid mixtures not fumed to dryness are not recommended as the results for many elements cannot be easily correlated within "total" results.

INTERPRETATION CRITERIA FOR EACH ELEMENT

Copper

Apart from the presence of nickel itself, the presence of significant quantities of copper must be considered an important guide to nickeliferous gossans. High copper levels imply the presence of sulphide mineralization; copper levels in leached outcrops can be higher than the nickel levels because copper enriches more strongly than nickel in the leaching environment. Copper may also be high in black shales which need not be related to sulphide mineralization although they often are. High copper levels in a gossan appear to be a requirement for economic nickel mineralization at depth. Conversely low copper levels imply the absence of nickel sulphide mineralization. Copper levels of greater than 500 ppm are an indicator of sulphide mineralization.

Lead

Lead levels are usually very low in Archaean rocks from the Eastern Goldfields; if lead is present this may be due to an influx from some later geological source.

The upper background level for lead in the Archaean is approximately 50 ppm.

Zinc

Levels of zinc are generally low in the Archaean greenstones but they are higher in the acid and intermediate volcanics, and volcanogenic sediments, and are usually very high in black shale.

Zinc levels of greater than 1,000 ppm are common in black shale environments which can be close to mineralized greenstones. Consequently care must be taken in interpreting results with high zinc and copper values.

Cobalt

This element has been widely analysed in the course of mineral exploration, but it does not appear to help interpretation as there is no apparent cor-

relation on a regional scale with other elements of interest. Correlation within a given mineralized body may be possible but more work is required on this subject.

Cobalt shows a wide concentration range, commonly with values up to 1,000 ppm.

Chromium

It appears possible that the chromium level can be correlated directly with the degree of lateritization. Chromium is not leached out of the weathered material but builds up with the resistate minerals, usually as chromite.

Levels of greater than 500 ppm are typical in lateritized material.

Manganese

Like lead, primary manganese is usually low in the Archaean, and its presence may be due to an influx from later rocks. Manganese is concentrated in a lateritic environment so high manganese laterites will develop if a source of the element is available. The situation is further complicated because manganese acts as a scavenger of other elements particularly copper, lead, zinc and iron, so care must be taken in interpreting high levels of these elements if high manganese is also present.

Manganese values of greater than 1,000 ppm are not uncommon in lateritized samples.

Silver

Silver is enriched similarly to copper but is itself an indicator for non-nickel sulphide mineralization, particularly that of copper and lead sulphides, so low values are to be expected in the nickel sulphide gossans.

Levels of less than 3 ppm are typical.

Molybdenum

Molybdenum is an enrichment indicator which is a good pathfinder for copper sulphide mineralization, though it is usually absent from nickel sulphide mineralization. Levels of less than 5 ppm are typical.

Iron

High iron levels are usually related to lateritization, with most gossanous material containing less than 30 per cent iron.

Nickel

This element is the prime exploration target; the absence of nickel negates the possibility of nickel sulphide mineralization. Alternatively the presence of significant levels of nickel does not necessarily mean that sulphide mineralization is present. The presence of nickel indicates the presence of ultramafic rocks and laterites as well as sulphide mineralization. Separation may be made as follows:

1. *Nickel sulphide mineralization* is usually present as pentlandite and nickeliferous pyrrhotite, usually with chalcopyrite which is the source of the copper enrichment that is usually found with leached material derived from nickel sulphides.
2. *Weathered ultramafic rocks* commonly contain high levels of nickel, usually derived from olivines in the fresh rock. These are usually separated from the other types as the levels of most other elements are low.
3. *Laterites* derived from ultramafic rocks are characterized by high nickel values, typically 1,000 to 5,000 ppm, but can be very high e.g. greater than 1 per cent nickel. These samples can be separated from nickel sulphide mineralization by their higher iron, chromium and manganese and usually low copper. Laterites grade into weathered ultramafic rocks as they are derived from them.

Analysis of a typical nickel sulphide gossan
Range of results

Cu	Pb	Zn	Ni	Co	Cr	Mn	Ag	Mo	Fe
500 to 5000	less than 50	less than 100	1000 to 5000	less than 1000	less than 500	less than 500	less than 5	less than 5	10% to 30%
Typical value									
950	30	65	2200	300	350	230	3	<5	22%

All results are in ppm except iron which is expressed in per cent.

Description of results

The results of this survey are presented in Tables 20 to 22; space does not permit a detailed discussion of each result but summary remarks and inferences are shown in the relative columns.

*Premixed acids are used to avoid explosion risks, for precautions using perchloric acid see Steere (1972).

TABLE 20. GOSSANS AND RELATED ROCK TYPES

G.S.W.A. No.	Shoot, Prospector Ore Body	Location	Company	Cu	Pb	Zn	Ni	Co	Cr	Mn	Ag	Mo	Fe	Remarks	Inferences
35001	S.L.O.B.*	Kambalda	W.M.C.	630	42	6	165	17	361	20	3	9	1.2	Sulphide gossan	
35015/A	Otter Shoot	"	"	17,000	32	33	190,000	2,400	46	234	a	b	26.8	Gaspetite gossan	
35015/B	"	"	"	12,000	39	26	200,000	3,500	76	143	a	b	30.3	"	
35015/C	"	"	"	13,000	39	40	40,000	500	1,250	151	3	5	52.8	"	
35017	"	Mt. Martin	Great Boulder	350	36	116	19,000	76	1,690	652	a	b	9.3	Metasediment adjacent in mineralization	Ni mobilized into sediment
35019	Area 2	"	"	360	32	340	1,690	108	1,700	2,700	3	b	52.8	Gersdorffite, pyrrhotite gossan	High Zn, Cr and Mn implies lateritized metasediment
35024	Area 3 (south)	"	"	2,710	33	44	2,820	140	111	134	2	b	47.9	Relict sulphides in gossan	
35026/A	"	Carnilya Hill	B.H.P.	3,140	88	234	2,590	110	4,500	280		b	35.9	Sulphide gossan	Possibly lateritized metasediment
35026/B	"	"	"	4,010	52	73	13,000	880	870	236	4	b	51.0	"	
35030	J.H. Prospect	Pioneer	Newmont	530	20	5	900	69	280	278	a	8	7.8	"	
35033	B.B. Prospect	"	"	500	39	65	520	83	560	2,300	3	b	48.3	"	
35035	H.H. Prospect	"	"	2,140	56	2,000	6,000	600	1,260	164	3	14	45.4	"	
35037	Mt. Edwards	Widgiemooltha	Inco	730	25	39	1,160	60	450	388	18	b	6.7	Sulphide gossan adjacent to black shale	High Zn confirms black shale.
35045/A	5B	Spargoville	Selcast	3,310	111	582	7,250	220	650	189	3	5	37.6	Sulphide gossan	High zinc suggests an adjacent black shale
35045/B	"	"	"	2,680	102	1,100	11,000	415	890	350	4	b	43.9	"	or other sediment
35047/A	5A	"	"	2,550	32	113	10,500	110	1,300	108	2	b	16.8	"	
35047/B	"	"	"	1,740	68	58	1,450	67	1,630	152	3	b	21.6	"	
35048	Nepean	"	Metals Expl.	3,010	92	480	7,100	830	2,450	15,000	4	b	47.8	Lateritized sulphide gossan	High Zn, Cr and Mn implies lateritization and mobilization from adjacent metasediment
35071	Scotia	"	Great Boulder	3,600	24	90	17,000	429	803	1,162	a	b	18.6	Sulphide gossan	
35072	"	"	"	560	13	32	2,080	149	907	1,392	a	b	4.0	Silicified cap rock	
35076/A	Carr Boyd	"	"	2,250	15	17	10,000	376	224	165	a	b	12.7	Sulphide gossan	
35076/B	"	"	"	175,000	39	220	8,000	131	344	15	24	b	35.8	"	
35077/C	"	"	"	9,000	27	27	18,500	340	473	67	4	b	62.0	"	
35077/D	"	"	"	6,200	24	22	12,500	271	330	54	8	b	56.4	"	
35083	Shirley Shoot	Mt. Windarra	Poseidon	6,210	23	53	4,590	214	1,332	3,900	2	b	19.0	"	
35089	"	"	"	3,340	35	280	18,000	188	2,312	868	a	b	17.1	Sulphide gossan from disseminated sulphide adjacent to B.I.F. †	Zn probably from adjacent B.I.F. †
35098/A	Perseverance	Agnew	Selcast	590	16	12	920	39	288	745	a	b	6.6	Sulphide gossan	
35098/B	"	"	"	1,080	23	44	3,230	102	500	453	a	b	25.0	"	
35098/C	"	"	"	3,130	29	150	6,350	131	1,298	423	2	b	55.0	"	
35100	6 mile prospect	Kathleen Valley	Anaconda	600	14	40	860	48	1,053	149	a	b	16.4	Disseminated sulphide gossan	
35109/A	Mt. Keith	"	Metals Expl.	500	16	11	1,230	47	431	2,000	a	b	2.6	"	
35109/B	"	"	"	480	40	31	1,040	72	477	1,900	a	b	5.4	"	
35709/A	Redross	Widgiemooltha	Anaconda	2,030	27	54	1,700	80	2,330	413	2	b	36.7	Sulphide gossan with silicified black shale adjacent	
35709/B	"	"	"	1,240	23	300	520	69	11,500	488	a	b	29.2	"	High Zn and Cr implies lateritized black shale
35710/A	"	"	"	760	21	215	1,230	72	710	3,450	a	b	13.0	Discovery gossan	High Zn implies black shale
35710/B	"	"	"	620	23	81	570	70	4,330	324	a	b	33.1	"	High Zn and Cr implies lateritized shale
35710/C	"	"	"	750	29	48	520	54	890	147	a	b	11.4	"	
35710/D	"	"	"	690	19	47	240	21	950	128	a	b	8.0	"	
35711/A	"	"	"	1,080	35	68	940	103	560	360	a	b	32.5	Sulphide gossan	
35711/B	"	"	"	1,960	25	26	360	63	870	107	a	b	23.4	"	
35711/C	"	"	"	1,870	31	35	250	30	750	396	a	b	18.8	"	High Cr implies lateritization
35711/D	"	"	"	1,950	36	66	670	72	2,690	435	2	b	28.1	"	
35711/E	"	"	"	2,490	30	53	390	53	2,720	214	a	b	22.2	"	
35711/F	"	"	"	760	27	38	180	46	1,750	229	a	b	25.8	"	
35711/G	"	"	"	790	30	45	320	51	1,120	393	a	b	22.0	"	

TABLE 20. GOSSANS AND RELATED ROCK TYPES—continued.

G.S.W.A. No.	Shoot Prospector Ore Body	Location	Company	Cu	Pb	Zn	Ni	Co	Cr	Mn	Ag	Mo	Fe	Remarks	Inferences
35712	Dordie Rocks	Widgiemooltha	Anaconda	810	53	77	3,770	173	650	173	7	77	33.4	Sulphide gossan	
35713	" "	" "	" "	790	53	1,104	5,500	120	80	497	5	126	49.0	" "	
35714	" "	" "	" "	1,940	84	51	5,000	347	1,830	94	7	30	45.5	" "	
35715	" "	" "	" "	800	76	48	610	1,400	740	38	10	47	37.4	" "	
35716	" "	" "	" "	1,520	77	91	55,000	746	670	552	6	69	27.0	" "	
35717	" "	" "	" "	3,160	70	746	6,180	264	21,000	1,114	7	42	39.0	" "	
35718	" "	" "	" "	860	72	65	43,500	479	790	479	7	99	19.8	" "	
35719	" "	" "	" "	1,170	31	608	1,560	35	290	49	a	34	8.4	" "	
35720	Widgie No. 3	" "	" "	5,070	48	39	16,000	235	840	87	2	b	41.0	" "	
35721	" "	" "	" "	120,000	42	422	12,000	466	20,000	615	7	b	27.7	" "	
35722	" "	" "	" "	5,290	28	42	55,000	719	250	67	2	b	35.4	" "	
35723	" "	" "	" "	2,200	46	254	25,000	614	3,440	268	a	b	10.9	" "	
35724	" "	" "	" "	3,910	28	30	36,000	1,100	150	196	2	b	49.0	" "	
35725	" "	" "	" "	4,060	34	120	33,000	149	380	307	2	b	22.2	" "	
35726	Wannaway	" "	" "	1,400	23	164	5,800	94	420	220	a	b	15.0	" "	
35727	" "	" "	" "	400	14	73	1,740	33	510	177	a	b	4.6	" "	
35728	" "	" "	" "	4,190	37	290	17,000	307	970	126	a	b	29.8	" "	High Zn implies black shale
35729	Redross	" "	" "	3,700	42	96	5,130	317	410	334	3	b	53.0	" "	
35730	" "	" "	" "	1,300	38	65	560	120	530	4,500	a	b	24.0	" "	
35731	" "	" "	" "	1,310	39	142	3,830	237	3,230	240	2	b	34.2	" "	High Cr implies lateritization
35732	" "	" "	" "	1,640	30	98	950	109	2,530	158	a	b	24.4	" "	
35733	" "	" "	" "	3,770	61	299	3,630	232	2,840	285	3	b	55.6	" "	High Zn and Cr implies lateritized black shale
35737/A	Wannaway	" "	" "	490	12	50	1,960	135	320	576	a	b	4.4	Siliceous sulphide gossan	Low Fe due to silicification
35737/B	" "	" "	" "	1,910	14	134	5,120	1,000	180	4,000	a	b	11.3	" "	High Cr implies lateritization
35737/C	" "	" "	" "	630	13	55	2,180	116	460	583	a	b	5.7	" "	Low Fe due to silicification
35737/D	" "	" "	" "	510	15	42	1,680	22	240	226	a	b	5.7	" "	" "
35745/A	" "	" "	" "	760	20	54	4,390	181	1,040	660	a	b	4.6	" "	" "
35745/B	" "	" "	" "	680	18	48	3,690	178	920	734	a	b	4.9	" "	" "

119

All results in parts per million, except iron which is shown as per cent.
 a = less than 2 parts per million
 b = less than 5 parts per million

* Silver Lake Ore Body
 † Banded Iron Formation
 ‡ Sulphide gossan means nickel sulphide gossan

TABLE 21. SULPHIDE ORE AND RELATED SAMPLES

	Ore Body etc.	Location	Company	Cu	Pb	Zn	Ni	Co	Cr	Mn	Ag	Mo	Fe	Remarks
35038	Mt. Edwards	Widgiemooltha	Inco	2,680	55	20	95,000	2,300	270	39	5	b	53.5	Massive sulphide ore
35040	" "	" "	" "	3,800	52	46	50,000	1,400	350	273	5	b	34.6	Coarse interstitial ore
35043	" "	" "	" "	190	26	128	3,780	141	930	1,398	a	b	7.4	Disseminated sulphide ore
35050	No. 3 Sill contact	Nepean	Metals Expl.	44,000	52	23	74,000	4,600	170	22	19	b	46.3	Massive sulphide ore
35051	No. 3 Sill F/W contact	" "	" "	5,140	40	21	140,000	5,300	720	61	5	b	42.4	" " "
35052	No. 2 Lens	" "	" "	39,000	24	499	80,000	800	1,810	147	11	b	21.6	" " "
35068	830 ft. level	Scotia	Great Boulder	4,390	35	138	64,000	624	480	843	3	b	17.1	" " "
35069	" "	" "	" "	3,090	32	91	70,000	800	210	676	3	b	22.1	Disseminated sulphide ore
35080	" "	Carr Boyd	" "	30,000	22	112	9,410	515	140	136	6	b	15.3	Mineralized norite
35081	" "	" "	" "	5,090	32	25	43,000	1,200	80	52	3	b	36.1	Massive sulphide ore
35082	" "	" "	" "	2,690	28	33	19,000	658	290	170	3	b	27.1	" " "
35084	A Shoot	Mt. Windarra	Poseidon	1,410	46	108	60,000	638	790	343	4	b	45.0	Breccia sulphide ore
35087	" "	" "	" "	1,970	39	159	12,000	163	680	311	7	44	13.1	Sulphide ore in talc schist
35088	" "	" "	" "	1,880	42	77	17,000	249	1,430	2,000	2	b	10.5	Disseminated sulphide ore
35096	Perseverance	Agnew	Selcast	930	28	74	24,000	435	400	867	a	b	14.0	Massive secondary sulphide ore containing violarite
35097	" "	" "	" "	1,340	33	17	77,000	1,500	440	188	3	b	54.8	Massive primary sulphide ore
35099	" "	" "	" "	920	29	80	23,000	444	280	946	2	b	16.5	Disseminated sulphide ore
35113	" "	Mt. Keith	Metals Expl.	190	20	27	4,970	199	620	273	a	b	3.3	Secondary sulphide ore
35114	" "	" "	" "	150	19	22	4,740	155	430	306	a	b	5.0	Secondary sulphide ore
35115	" "	" "	" "	160	23	22	4,810	143	460	249	a	b	5.5	Primary sulphide ore
35119	No. 5 level Lunnon Shoot	Kambalda	W.M.C.	1,940	49	50	59,000	788	520	1,100	3	b	36.9	Disseminated sulphide contact ore
35748	Perseverance	Agnew	Selcast	1,120	31	27	86,000	1,450	280	157	2	b	43.4	Disseminated secondary sulphide ore with violarite
35749	" "	" "	" "	10	21	21	2,610	82	340	628	a	b	4.4	Serpentinite with violarite and pyrite
35750	" "	" "	" "	660	27	50	17,000	333	160	411	2	b	14.9	Primary sulphide matrix ore
35751	" "	" "	" "	410	29	40	20,000	433	180	428	2	b	17.1	Primary disseminated sulphide ore
35752	5A	Spargoville	" "	3,610	47	86	60,000	1,000	210	378	4	b	35.0	Primary matrix sulphide ore
35753	" "	" "	" "	680	27	47	18,000	302	750	121	a	b	5.7	Primary disseminated sulphide ore
35754	" "	" "	" "	3,410	43	33	77,000	1,280	40	133	5	b	48.6	Primary massive sulphide ore

All results in parts per million, except iron which is shown as per cent.

a = less than 2 parts per million

b = less than 5 parts per million

TABLE 22. LATERITES, FALSE GOSSANS AND RELATED ROCKS

G.S.W.A. No.	Location	Company	Cu	Pb	Zn	Ni	Co	Cr	Mn	Ag	Mo	Fe	Remarks
35006	Kambalda	W.M.C.	430	100	106	14	17	361	20	3	9	1.2	Chert
35031	Pioneer	Newmont	90	21	64	730	6	30	30	a	b	0.1	Magnesite "Ni" scavenger
35065	Lake Yindarlgooda	580	34	349	40	27	147	355	4	b	26.3	False gossan
35094/A	Mt. Windarra	Poseidon	510	16	430	119	15	275	1,157	a	b	5.6	B.I.F.*
35094/B	Mt. Windarra	Poseidon	20	18	362	30	10	280	1,180	a	b	4.1	B.I.F.*
35111	Mt. Keith	Metals Ex.	810	39	230	3,520	140	2,200	371	3	b	64.0	Ferruginous laterite
35112	Mt. Keith	Metals Ex.	570	29	50	450	62	11,000	114	3	b	64.1	Ferruginous laterite
35584	Leonora (1:250,000)	50	28	289	170	98	180	250	3	b	57.7	Ferruginous laterite
35585	Leonora (1:250,000)	200	35	78	120	49	710	68	3	b	38.3	Laterite
35592	Leonora (1:250,000)	20	32	19	140	62	1,580	223	4	b	58.9	Ferruginous laterite

*Banded Iron Formation.

All results in parts per million, except iron which is shown as per cent.

a = less than 2 parts per million
b = less than 5 parts per million

Table 20 gives the analysis of typical gossans; Table 21 contains analyses of the sulphides from which the gossans were derived; Table 22 presents false gossans, laterites and other non-economic derived samples.

Special comment is made of samples 35712 to 35719 (Table 20) from Dordie Rocks; these as a group contain very high molybdenum. Also, samples 35094/A and 35094/B (Table 22), though described as banded iron formations from field occurrences, cannot be so (sensu stricto) as the iron content is too low. They would probably be better described as surface iron-enriched sediments with banding.

It is worthy of note that significant variations in results have been obtained from the analysis of separate pieces of the same sample and that samples from the same general location are similarly variable. Localized leaching effects may have been very important in the development of this material.

CONCLUSIONS AND RECOMMENDATIONS

SAMPLING

The collection of samples for gossan analysis must be undertaken with consideration for the physical and chemical characteristics described. When collecting, sample all ferruginous material approximating the physical descriptions presented earlier. If possible collect a few samples from each outcrop and a few from adjacent outcrops. Ensure that all samples are analysed. The analysis of a moderate number of samples (say 10) is necessary to overcome the variability of individual samples; multiple sampling is much better than bulking the samples and treating them as a single analysis. Bulking automatically gives an average which reduces the geochemical contrast and it is the contrast that gives rise to an anomaly.

ELEMENTS DETERMINED

It is considered that the following elements at least should be determined: Copper, lead, zinc, nickel, chromium, manganese, and iron. If fewer than those are analysed it would be possible to miss

a significant anomaly. It may be worthwhile to analyse for other elements but many detailed analyses are necessary to fully evaluate them.

ANALYTICAL METHOD

The method described here is recommended, though any other method that yields a "total" element result would be satisfactory.

SUMMARY OF INFERENCES

1. Gossans developed over nickel sulphide mineralization are characterized by high copper and nickel results.

2. High zinc results may be due to the presence of sediments especially black shales.

3. Lateritized samples are commonly characterized by high chromium, manganese and iron.

Little correlation appears possible with cobalt, silver and molybdenum. Lead is normally low in all samples.

CONCLUSION

From the collection and analysis of multiple samples from leached outcrops related to nickel sulphide, it is possible to establish criteria for the separation of true gossans from false gossans and laterites.

ACKNOWLEDGMENT

The assistance obtained from the various companies in collecting these samples is appreciated as is that freely given by members of the Mineral Chemistry Division of Government Chemical Laboratories who carried out the analytical work.

REFERENCES

Blanchard, R., 1968, Interpretation of leached outcrops: Nevada Bureau of Mines Bull. 66, 196 pp.
Mazzuchelli, R. H., 1972, Secondary geochemical dispersion patterns associated with the nickel sulphide deposits at Kambalda, Western Australia: Jour. Geochem. Explor., 1, p. 103-116.
Steere, N. V., 1972, Hand book of Laboratory Safety: 2nd ed., Chemical Rubber Co., Cleveland, Ohio.

A PILOT STUDY OF PHOSPHORUS DISTRIBUTION IN PARTS OF THE BROCKMAN IRON FORMATION, HAMERSLEY GROUP, WESTERN AUSTRALIA

by R. C. Morris *

ABSTRACT

Electron microprobe examination of core from the Dales Gorge Member of the Brockman Iron Formation confirmed that the bulk of the phosphorus is present as apatite; but some of the matrix minerals also contain traces of phosphorus, and rare grains of monazite were detected. A phosphate stain printing technique using a one-solution molybdate-ascorbic acid-based reagent, was developed and used to determine the phosphate distribution in some 110 m of drill core from a number of separate holes. The vertical distribution is variable but is typically banded on a scale similar

to the mesobanding, but to some extent independently of it. While imperfect lateral continuity can be traced over a number of holes in a restricted area, striking anomalies are present in equivalent sections 80 km apart. There is no obvious correlation between phosphate concentration and specific mesoband type, but cyclic phosphate occurrence is present in several cyclothem sequences. The distribution may best be explained

* Division of Mineralogy, C.S.I.R.O., Wembley, W.A., present address Delta Petrological Services, 37 Carrington Street, Claremont, W.A.

by erratic influx of phosphate into the basin and local biochemical precipitation, although migration of phosphate during or after consolidation may also be involved. This pilot study did not include quantitative determination of phosphorus present in the iron formation.

INTRODUCTION

SUMMARY OF GEOLOGICAL BACKGROUND

The 2,000 million year old Hamersley Group, with a usual thickness of 2,400 m, is typified by an abundance of banded iron formation, which is interstratified with shale, dolomite and acid lava, and at some levels intruded by thick dolerite sills. Its present outcrop area is bounded approximately by latitudes 21° to 22°S and longitudes 116° to 120°E. The group, as originally defined by MacLeod and others (1963) and amended by Trendall and Blockley (1970), is subdivided as follows:

Boolgeeda Iron Formation
Woongarra Volcanics
Weeli Wolli Formation
Brockman Iron Formation — Yandicoogina
Shale Member, Joffre Member, Whaleback
Shale Member, Dales Gorge Member
Mount McRae Shale
Mount Sylvia Formation
Wittenoom Dolomite
Marra Mamba Iron Formation

Important hematite ore bodies lie within both the Joffre and Dales Gorge Members of the Brockman Iron Formation. The Dales Gorge Member was formally defined by Trendall and Blockley (1968), using 142.11 m (466.25 feet) of core largely from a single hole (47A) at Wittenoom as the type section. Blockley (1969) has illustrated clearly the stratigraphic equivalence of the unenriched Dales Gorge Member and the hematite ore derived from it by metasomatic replacement.

The terminology in this report follows that of Trendall and Blockley (1970) but three of their terms will be explained here to allow independent reading of this paper.

1. **Macrobanding:** the Dales Gorge Member is divided into 33 macrobands, consisting of BIF 0 to BIF 16, made up of iron formation, alternating with S1 to S16 which are generally thinner and consist of shale, chert and siderite.

2. **Mesobanding:** the conspicuous striped succession of internally consistent bands of different composition, with an average thickness of less than about 3 cm, present in the iron formation, and seen prominently in cores figured in this paper despite the reduced scale of the photographs. Trendall and Blockley (1970) classify mesobands on the principal mineral constituent, rather than using a more detailed but unwieldy classification involving the known combinations of the iron formation minerals.

3. **Microbanding:** an alternation, typically within chert mesobands only, of regular repetitive laminae of even thickness, usually within the range 0.3 to 1.7 mm and defined by varying content of some iron-bearing mineral.

RATIONALE, SCOPE AND OBJECTIVES OF THIS STUDY

The small amount of published data on phosphorus content of Hamersley Group iron formations indicates an average of about 0.14 per cent P (Trendall and Blockley, 1970). Different deposits of high-grade hematite within them are known to vary from 0.03 per cent P to 0.15 per cent P (MacLeod 1966), but material of the latter kind is not currently saleable as ore. Little is known of the movement of phosphorus during the enrichment process, and as a foundation for a study of this, a survey was undertaken of the form of occurrence, and the distribution, of phosphorus in selected sections of the Brockman Iron Formation from which fresh core material was available and which were known to contain important hematite ore bodies.

The form of phosphorus occurrence was first studied using an electron microprobe; after this had established that the bulk of the phosphorus is present as apatite the distribution of phosphate was studied using a stain printing technique, which was developed for the purpose. This technique, and the results of both phases of the investigation, are described in this paper.

The work was carried out in the Division of Mineralogy, Commonwealth Scientific and Industrial Research Organisation, with the active cooperation of the Geological Survey of Western Australia.

MATERIAL USED

The bulk of the material used in this investigation was drill core from a single hole (Hole 47) near Wittenoom, drilled as part of an exploration programme for crocidolite (Trendall and Blockley, 1970). This hole penetrated parts of the Joffre and Dales Gorge Members and the whole of the Whaleback Shale Member. Selected sections of the resultant core, totalling about 86 m, are exhibited in stratigraphic sequence as 48 vertically sawn and polished half-core columns, each about 180 cm high, mounted permanently in the wall of the entry area of the Geological Survey on the 5th floor of Mineral House, Adelaide Terrace, Perth. The undisplayed parts of this sawn core are preserved by the Geological Survey for detailed studies of this kind.

The whole of the undisplayed half of column 1 of this wall exhibit was prepared for the electron microprobe study, but only part was examined. The column comes from the BIF 4 macroband of the Dales Gorge Member, just below the S5 macroband.

The stain printing was carried out on the actual displayed surface of the wall exhibit, which includes part of the Joffre Member, a small section of Whaleback Shale Member, and all or part of the following Dales Gorge Member macrobands: BIF 4, S5, BIF 5, S6, BIF 11, S12, BIF 12, S13, BIF 13, S14, BIF 14, S15, BIF 15, S16, and BIF 16. A further 20 m of core selected from several different holes for lateral correlation was also treated, and the phosphate prints photographed alongside their respective cores. This material includes some equivalent sections of the Dales Gorge Member BIF 2 macroband from Holes 20, 28, 33, 40, 46, and the type section all near Wittenoom, as well as short sections from Junction Gorge, 80 km to the east, and their equivalents from the type section.

ELECTRON MICROPROBE RESULTS

APATITE

Qualitative data from the electron microprobe indicate the mineral is a calcium phosphate with chlorine and fluorine below the detection limit of the instrument; it is therefore probably a hydroxy-apatite.

In general the individual apatites seldom exceed 20/μ in diameter, and are commonly very much smaller. Some of the main textural varieties have been described by Trendall and Blockley (1970), whose figure numbers are referred to in the immediately following text, and with the exception of the type shown in their Figure 35C all have been observed in the material examined. Since many of the grains are below 5/μ and closely associated with varied fine-grained matrix minerals it is not always possible to categorize them. In addition to the fine spots in chert (Fig. 35, F) the probe has detected similar specks in stilpnomelane (common), minnesotaite (sometimes) and riebeckite (rare).

There is a general tendency for a single P-band* to contain the same apatite form; thus 1-2/μ spots may be the major feature of one P-band, 5-15/μ clear euhedra another, and so on. The richer P-bands often contain the skeletal forms shown in

* See definition on page 78.

Figure 35, A, and in high concentrations these may form a semi-continuous network anastomosing through the chert. In one chert-carbonate meso-band which was virtually free of phosphate, tiny apatite spots were found in the chert centres of a few of the "atoll" textured ankerites which were a common feature of this band.

Despite the variety of forms present in the samples it seems possible to divide them into three main groups:

- (1) The globular and cigar-shaped forms with turbid centres, (Fig. 35, D and E). (The fine dusty inclusions have been identified as some form of iron oxide with the probe).
- (2) The fine anhedral spots included with the matrix minerals such as chert (Fig. 35, F).
- (3) The interstitial forms such as the clear 5-15/u euhedra, and the skeletal forms (Fig. 35, A). Some implications of this division are discussed later in this report.

RARE EARTH PHOSPHATE

Traces of a rare-earth phosphate were found in some samples. Qualitative results indicate this is a thorium-free monazite, and observations in reflected light suggest the mineral is probably diagenetic but may represent reorganized detrital material.

Since most of the probe work was aimed at examining the distribution of phosphorus in the bands, rare earths were monitored only in a few specimens and thus the distribution is still unknown. However it is unlikely that anything more than traces are present.

PHOSPHORUS IN THE MATRIX MINERALS

In general the phosphorus content of the magnetite, hematite, carbonates and silicates is close to the detection limit of the probe. Typical results showed a small positive count over the background values, but the standard deviation is commonly twice that of the values obtained, for example 0.01 ± 0.02 per cent. In apatite-rich bands, counts for phosphorus in the associated minerals rise significantly. However this may well be backscatter from the closely attendant apatite, and further study is needed. Phosphorus was not detected in chert (i.e. quartz).

PHOSPHATE STAIN PRINTING: TECHNIQUE

The following method is based mainly on a modification of a one-solution reagent described by Murphy and Riley (1962) for photometric analysis of phosphate in natural waters and on standard chromatographic techniques.

REAGENTS

- (1) Ammonium molybdate (4 per cent in H₂O)
- (2) Nitric acid 5N.
- (3) Potassium antimonial tartrate (0.3 per cent in H₂O) (Stabilizing agent).
- (4) Ascorbic acid (2 per cent in H₂O) (Reducing agent).

The reagents are prepared as stock solutions with the exception of ascorbic acid which is freshly made before use.

These are mixed in the following sequence:

- 25 parts (1) mixed thoroughly with
- 20 parts (2)
- 3 parts (3) added and mixed.
- 15 parts (4) added and mixed.

These ratios are not critical. In some situations (i.e. high phosphate) the molybdate could be decreased to aid resolution. Depending on the temperature the mixture is stable for several hours, but it is best to prepare small quantities at intervals of 2-3 hours or less, when printing large areas.

SUBSTRATE

The ideal material for stain printing would be a thin, soft, strong membrane, finely porous but not permeable, capable of holding the optimum amount of solution and limiting diffusion to the immediate vicinity of the test grains.

Treated photographic papers and films (Williams and Nakhla, 1951) were found to be useful for small, smooth surfaces, although carbonate effervescence tends to lift these impervious membranes from the surface and to spread the stain; but for the large-scale tests involving tens of metres of core, resolution was sacrificed for convenience. For this project 5 cm wide rolls of Whatman No. 1 chromatographic paper were used. For the first trial runs the paper was surfaced with methyl cellulose (to limit diffusion of the stain), but considerable difficulty was experienced in preparing consistent coats over long lengths, and the technique was abandoned for the bulk of the project. Resolution with this methyl cellulose surfaced paper approaches that of the photographic emulsions, but satisfactory results for this general study were obtained with untreated paper.

PROCEDURE

1. A smooth, preferably polished surface, produces the best results but adequate resolution for most purposes can be gained from the outer surface of untreated core.

2. The surface should be thoroughly cleaned, avoiding the use of phosphate based detergents.

3. Impregnate the required length of paper strip with test solution. The reagent applicator used for this project is illustrated in Figure 43. The paper should be damp, not wet, but the required dampness can only be determined by trial. The paper may be left to dry for several minutes without affecting the process.

4. The treated strip is laid on the core, covered with clean paper towelling and rolled with a rubber roller to give a close contact with the surface and to remove excess reagent. Curved sections (e.g. uncut core) are treated in the same manner except that instead of rolling, a strip of foam plastic covered with thin polythene is laid over the covering paper and pressed firmly against the core with a semi-circular portion of a tube, (a cardboard tube cut longitudinally is satisfactory). Contact time is a matter of experiment, and will depend on how much reagent is present in the test strip; 10-15 seconds is usually adequate. On flat surfaces or where the strip remains in close contact with the specimen the developing blue stain can be examined by removing the covering paper. However, with curved surfaces it is best to retain the pressure for a fixed time to produce an even finish.

5. Having struck a balance between time of contact and diffusion of the stain, the strip is removed. The stain will continue to develop, reaching a maximum intensity within a minute or so, but will also continue to diffuse. Photographing the strip at the optimum moment seems to be the best method of preserving a permanent record.

The process may be repeated several times with fresh strips without loss of detail on smooth surfaces, but less effectively on the relatively porous surface of untreated core.

Once the strip has dried, the deep blue colour of the molybdate stain will fade, the particularly rich areas then forming a bluish green effect apparently due to the potassium antimonial tartrate. Without this stabilizing component the molybdate blue will oxidize to a pale yellow colour due to the action of the nitric acid.

The original deep blue colour can be recovered by spraying the strips with 1 to 2 per cent ascorbic acid solution, but further diffusion may occur and sometimes an overall blue stain will obscure the detail. Bright light also produces confusing blue stains, so that once the acid has been allowed to disperse, the strips should be stored in the dark.

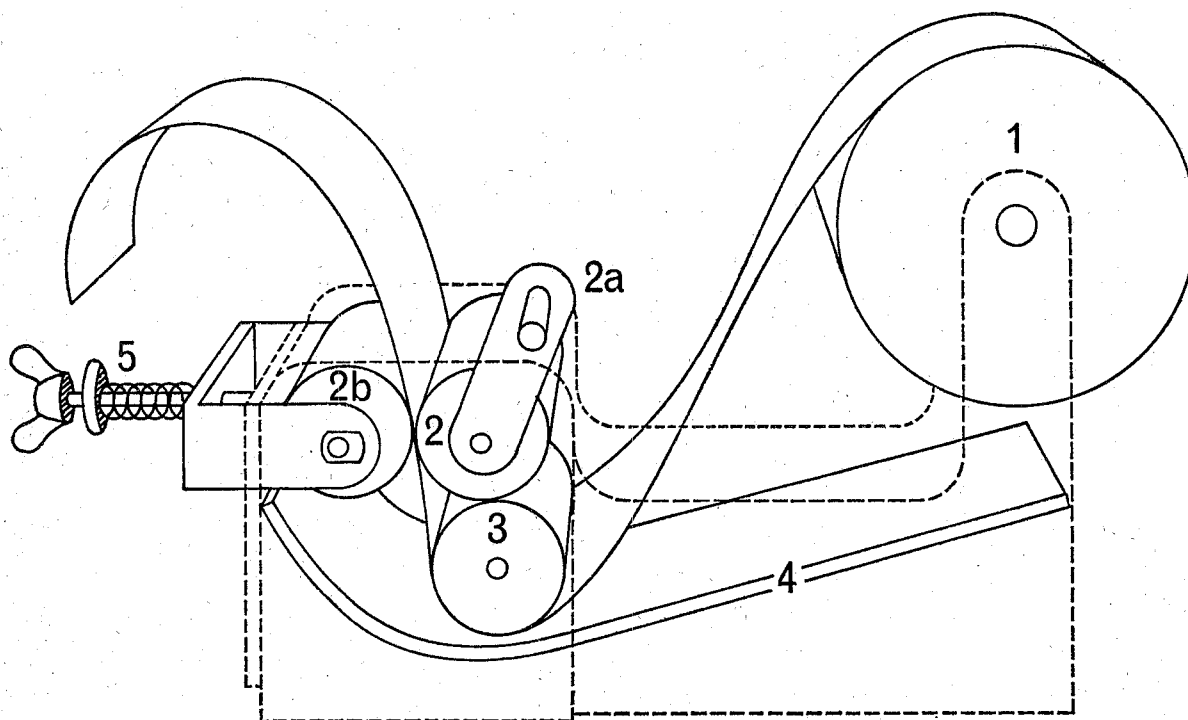

Figure 43. Reagent applicator for large scale stain printing of core. The device is made from acrylic sheeting, and the rollers from acrylic bar, using stainless steel accessories.

To start the process, the free end of the paper is moistened and placed in contact with the driving roller (2). Rotation of the handle (2a) draws the paper between the two rollers (2 and 2b). The free roller (3) is placed into the bath (4) on top of the paper, keeping it immersed in reagent. Roller pressure is adjusted (5) to squeeze out excess reagent.

Strips about 120 cm long are the maximum that can be conveniently handled, and the first 10 to 20 cm of this are discarded since they are usually too wet for use after standing in the reagent for some time.

The technique as described is still in a crude form and could undoubtedly be improved. Nevertheless, when treating small sections the method can resolve grains of the order of a few microns and by drying the paper in a blast of warm air, diffusion can be effectively limited. This printing method is not necessarily restricted to banded iron formation of for that matter to apatite. It could be used for virtually any acid soluble phosphate. At the acid strength used here the test is specific for phosphate in the presence of silica. Elements such as arsenic have not been tested. Perspiration reacts with the reagent damped paper to produce a blue stain and tobacco ash also produces some interesting anomalies. As a skin protection and to avoid finger printing the paper polythene gloves were worn during the process.

PHOSPHATE STAIN PRINTING: RESULTS

A selection of typical core segments with their corresponding phosphate prints is illustrated in Figures 44, 45 and 46.

Figures 44, 45, and 46 show a selection of core photographs with matching phosphate prints prepared from an exhibit of vertically sawn and polished Brockman Iron Formation core from Hole 47 at Wittenoom. The phosphate print is the left hand member of each column pair, and shows the phosphate (apatite) distribution laterally reversed with respect to the parent core. The core has a nominal diameter of $2\frac{1}{4}$ in. (5.4 cm). The column numbering of the figures corresponds with that of the exhibit. The phosphate print was photographed alongside a scale marked from 0 to 180 cm, with the zero marking the base of each column. The scale is included in the figures for convenient reference. The polished core is bedded in portland cement, and breaks and other imperfections are seen in the core photographs, and to some extent mirrored in the phosphate prints, as white lines and markings.

These prints clearly show the marked banding of the apatite distribution, and the wide variation in the type and intensity of the bands. Due to problems of reproduction it may not always be possible to see the remarkable conformity between lithology and phosphate distribution, but in many cases the phosphate prints accentuate features not readily seen on the polished surfaces themselves. Under optimum conditions the prints accurately show the distribution of small individual apatite grains. However as the phosphate content of a layer increases, the spots coalesce, and at some unknown value (possibly 5 or more per cent apatite) a continuous ribbon of colour is produced. It is difficult to apply quantitative judgements to the prints since carbonate effervescence, excessive reagent and contact time all tend to increase diffusion of the stain.

To avoid nomenclatural confusion, the term P-band is applied to a stratigraphic horizon defined by the presence of sufficient phosphate to produce a distinct band of colour on the phosphate print, contrasted against whatever background level is present. In discussion, the term P-band may also be applied to the print itself but the context will make this clear.

Figure 44 (opposite)

Phosphate distribution in parts of the Dales Gorge Member, Hole 47 at Wittenoom

- Column 1. Part of the BIF 4 macroband just below the S5 macroband. The undisplayed half of this column was used for electron probe studies.
- Column 2. 0-81 cm BIF 4
81-145.6 cm S5
145.6 cm to top BIF 5

It can be seen that there is no significant difference between the phosphate distribution in the three macrobands represented in this column.

- Column 3. BIF 5.

- Column 4. BIF 5. The central part of this column contains a podded zone accentuated by the variations in the phosphate print.

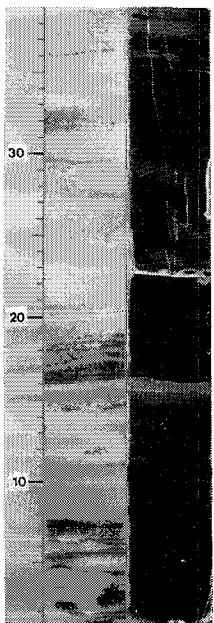
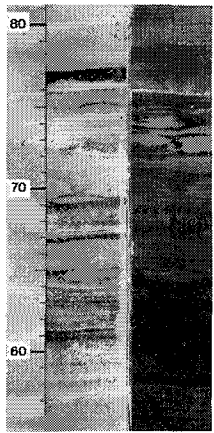
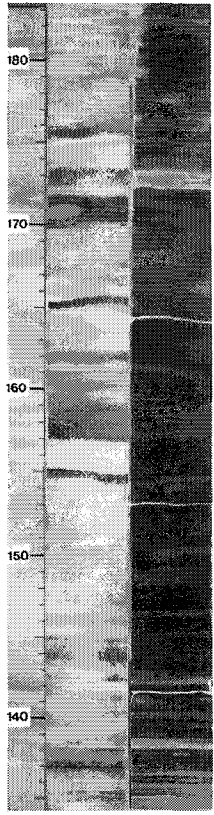

Column 1

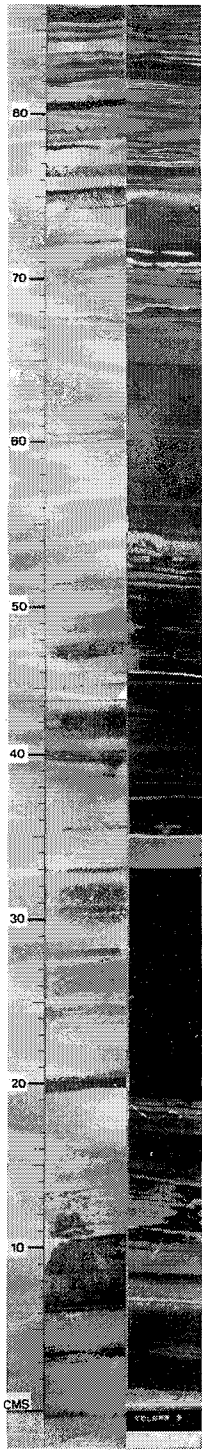

Column 2

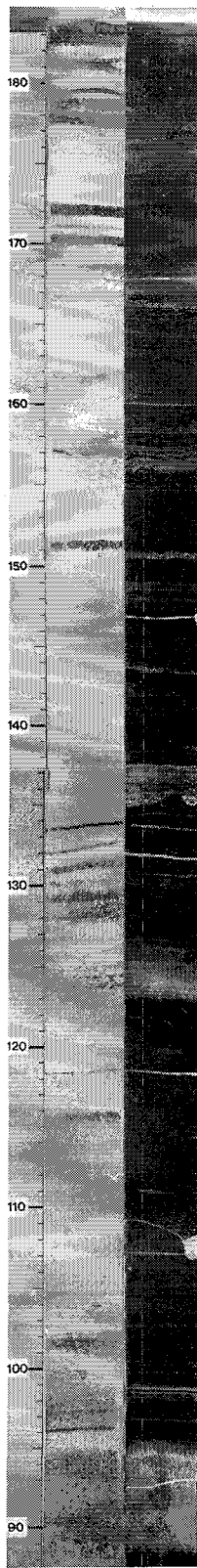

Column 2

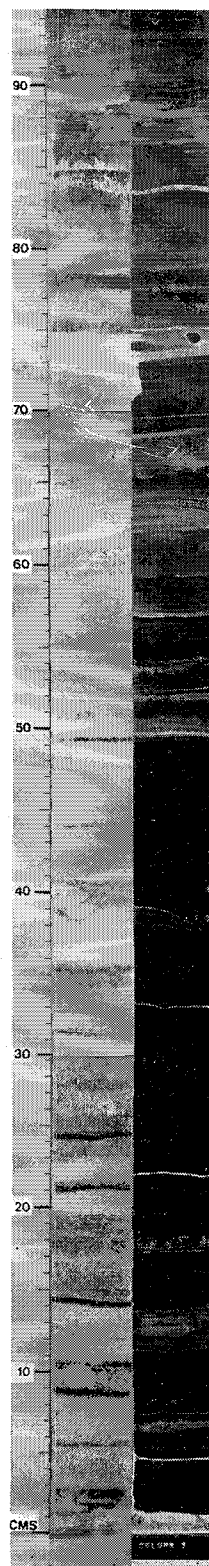

Column 3

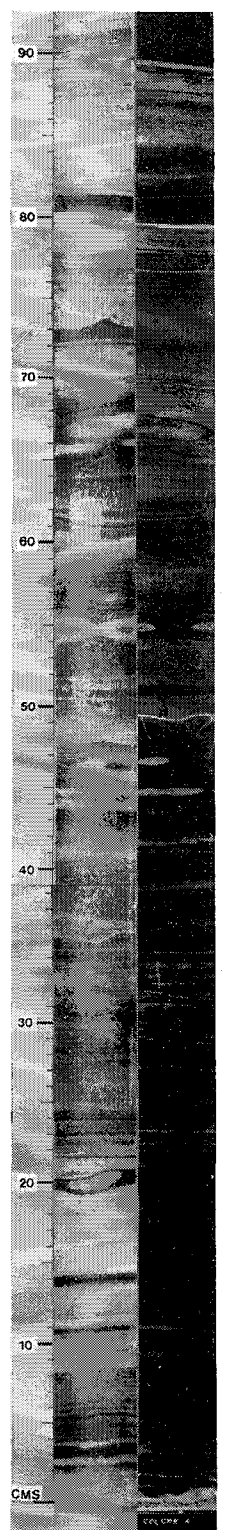

Column 4

Figure 44

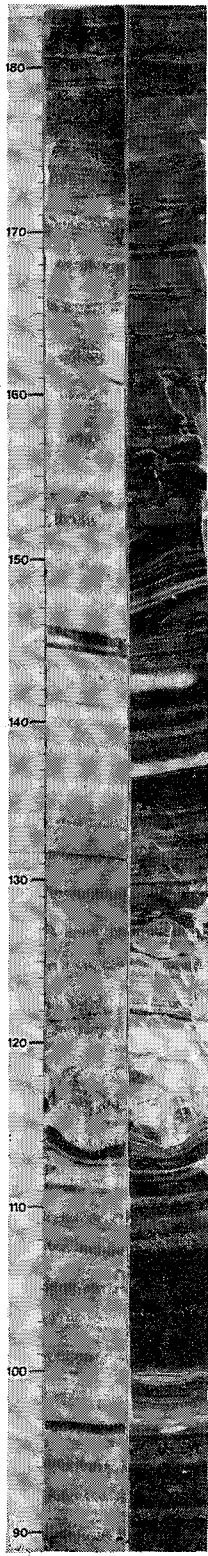

Column 7

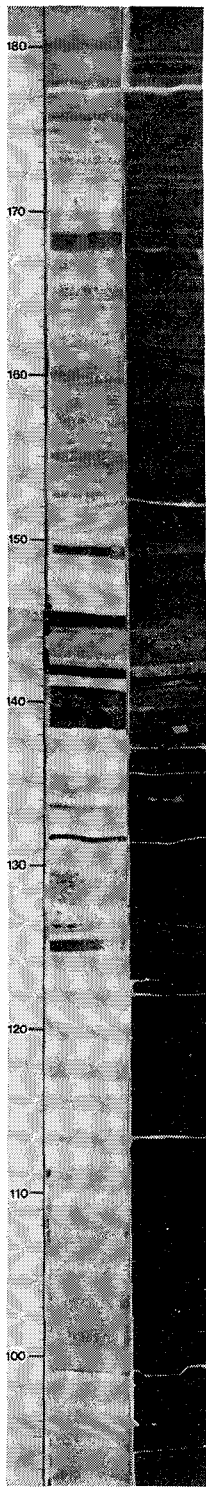

Column 8

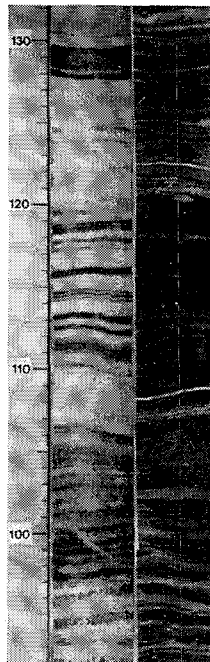
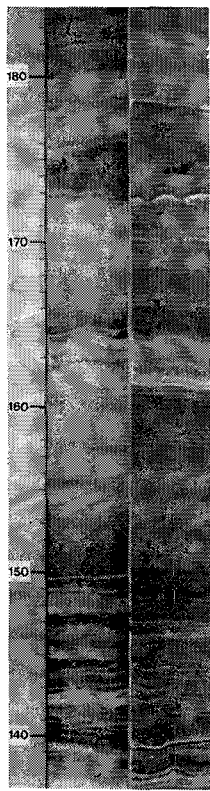

Column 11

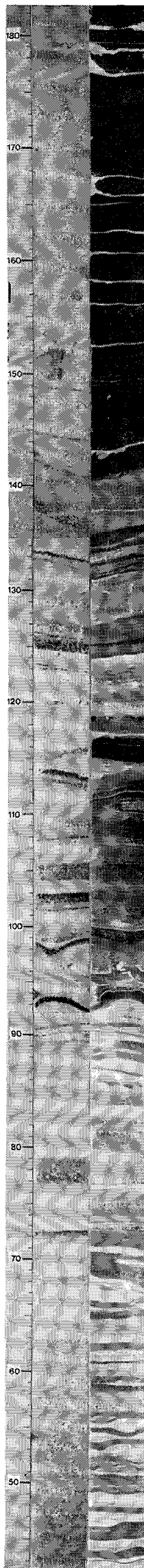

Column 13

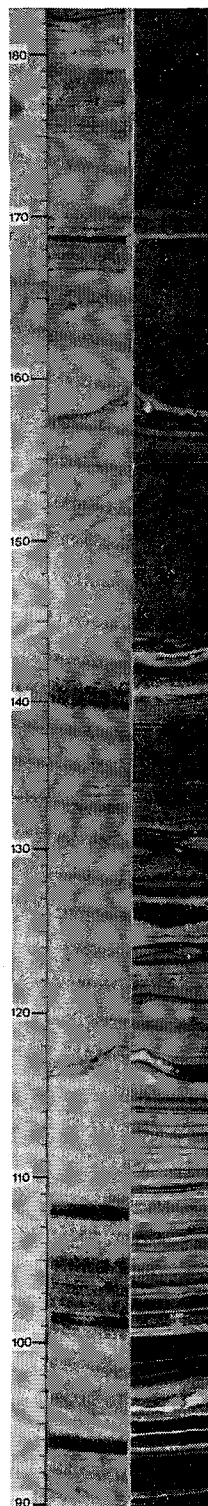

Column 19

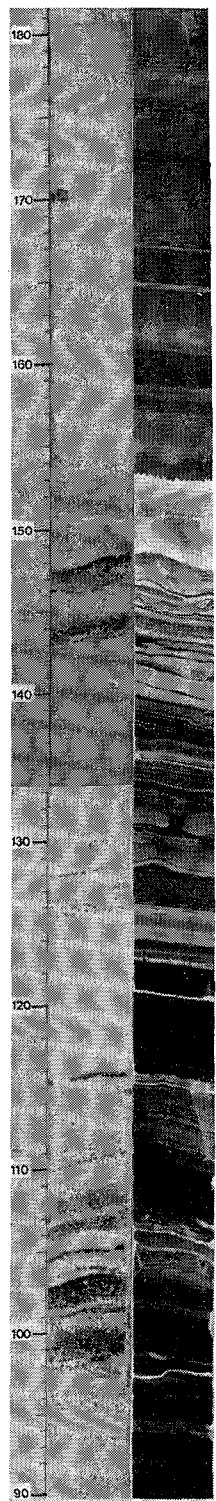

Column 22

VERTICAL PHOSPHATE VARIATION IN BIF MACRO-BANDS

The most striking feature of the phosphate prints is the marked banding of the phosphate distribution. P-bands as defined above may be of single-grain thickness, and correspond exactly with the microbands within chert mesobands, or they may extend up to several centimetres, and include minor internal fluctuations. In addition the prints may show diffuse zones (which may include P-bands) with varying, but low levels of colour intensity, as well as zones too low in phosphate to produce significant colouration.

Although one or both edges of a P-band may coincide with mesoband boundaries, so far no clear correlation between phosphate and a specific mesoband type or even a mesoband group has been found. There is, however, good evidence for a cyclic deposition in some zones where the cyclothem are well developed. For example, one Calamina cyclothem group of BIF 16 appears in column 34 of the wall exhibit (Fig. 46, A). The print of this column shows a remarkably symmetrical phosphate distribution matching the various bands of the cyclothem.

One of the interesting features of the prints is seen within podded zones, and zones of slumping and brecciation, where the phosphate distribution follows the contortions with remarkable precision. Some of these appear in Figure 46, C.

There is a clear difference between phosphate prints of the Dales Gorge Member and of the part of the Joffre Member included in the wall exhibit. Typical prints of the latter appear in Figure 46, B and reveal the dominance of narrow rich P-bands separated by low-phosphate zones, unlike the much more varied Dales Gorge Member prints. If these prints are typical of the entire member, it would appear that the Joffre Member has a lower total phosphate content than the Dales Gorge Member and that the lithological differences between the two members categorized by Trendall and Blockley (1970) are also reflected in the phosphate distribution.

LATERAL PHOSPHATE DISTRIBUTION IN BIF MACRO-BANDS

To test the lateral continuity of P-bands a number of correlative core sections from different drillholes up to 5 km apart in the Wittenoom area were stain printed; in general, there is excellent correspondence of mesobanding, though podding and some core gaps prevent perfect correlation throughout. It was not possible in the time available to devise an objective and quantitative technique of matching prints, but a qualitative judgement suggests that at least half of the P-bands can be traced between cores of different holes. While the failure to correlate certain P-bands between holes may be due to mis-matching of mesobands this explanation is unlikely to cover all such instances; also, the undoubted lack of P-band continuity over 80 km, described below, lends credence to the view that much of the observed P-band discontinuity within the limited Wittenoom area is real.

Figure 45 (opposite)

Phosphate distribution in parts of the Dales Gorge Member, Hole 47 at Wittenoom

Column 7. BIF 11. The complex structure at 120 cm is portion of a macule (a nodule-like thickening of a group of mesobands).

Column 8. 92-144.7 cm S12.
144.7 cm to top BIF 12.

Column 11. BIF 12. Note that the complex fine lensing between 50 and 55 cm is perfectly mirrored in the phosphate print.

Column 13. 42-104.3 cm BIF 12.
104.3 cm to top S13.

This part of S13 is fragmented and the embedding cement is reflected in the phosphate print as phosphate-free markings.

Column 19. 0-3 cm BIF 13.
3-98 cm S14.
98 cm to top BIF 14.

Column 22. 0-146 cm BIF 14.
146 cm to top S15.

S15 appears to be almost free of phosphate judging from the virtually blank print. Compare this with S13 which shows a diffuse distribution but without significant phosphate banding.

The P-band and mesoband correlation between a short length of core from Hole JG2 at Junction Gorge and the type section of the Dales Gorge Member (Hole 47A at Wittenoom) appear in Figure 47, A. Attention is directed especially to the reversal of the phosphate content of certain indisputably correlative mesobands: that is, P-bands in one core are matched almost exactly by phosphate-poor bands in the other, and *vice versa*.

Further correlations were attempted using material from which Figure 15 of Trendall and Blockley (1970) was prepared to illustrate fine-scale long-distance stratigraphic correlation. These prints, together with a reproduction of Trendall and Blockley's Figure 15, are shown in Figure 48. Though the rocks from which these prints were prepared are, with the exception of the core sample, somewhat weathered, the results suggest that while some correlation may be inferred for C and D, which are 30.6 km apart, there is none between A, B and D, which form a triangle with sides 148, 233 and 298 km in length, despite the excellent lithological correspondence at the microband level.

The limited evidence of this study suggests that the present lateral distribution of phosphate within specific horizons is either discontinuous or a localized feature. Nevertheless it is possible, indeed probable, that some basin-wide correlations could be made, particularly for sequences such as those present in column 34.

PHOSPHATE DISTRIBUTION IN S MACROBANDS

Two general conclusions may be drawn from the stain prints of S macrobands shown in Figures 44 and 45. Firstly, where marked P-banding is present within S macrobands it has no distinguishing characters from that of BIF macrobands. Secondly, lithologically uniform shale seldom shows P-banding; S15, for example, shows an almost blank print. The short length of Whaleback Shale in the panel is similar to S macrobands of the Dales Gorge Member, such as S5, S14, and S16, which are P-banded like BIF.

DISCUSSION

Two contrasted explanations are available for the phosphate distribution illustrated:

- (1) Deposition of phosphate takes place on a basin-wide scale conforming to the regular precipitation of the matrix and possibly connected with the same cyclic phenomenon, but it is subsequently redistributed by local conditions during and/or after consolidation.
- (2) The phosphate is deposited independently of the matrix, controlled by local variations of the phosphate content of the water of the basin, and though modified by later processes remains essentially within the original horizons.

An association of apatite-rich bands with hematite is perhaps consistent with the observation of Bonatti and others (1971) that phosphorus concentrates within the oxidized top layers of sediments. However, this is a minor feature and limited to very narrow bands. The possibility of a reducing atmosphere (Cloud, 1968) and the rapid rate of sedimentation would probably limit this process. The remainder of this discussion is concerned mainly with the second explanation.

Part of column 1 (Fig. 46, D) represents one of the more complicated segments of the short length of core examined with the electron microprobe. The results for this zone made little sense until the phosphate print was available, since in terms of the probe beam diameter the individual apatites are far apart, despite the apparent overall continuity shown in the illustration. Other similarly contorted, as well as regular patterns are also illustrated in Figures 44, 45 and 46, and are quite typical of the much greater length of tested core.

The significance of all these patterns is in the evident close relationship of phosphate to the individual sedimentary layers. If it is argued that

the phosphate banding is the result of preferential concentration during consolidation and compaction then an answer is required as to why one mesoband should contain apatite while a few centimetres higher or lower in the sequence the phosphate prefers a different host. In fact, it seems likely, though more checking is required, that at one place or another every major mesoband variety will show a complete range of phosphate concentration.

It could still be argued that the phosphate was uniformly precipitated with the matrix material, or as a cyclic phenomenon within specific mesoband types, and that the present distribution reflects a physical property of the host, porosity for example, or a combination of unknown factors. But examination of prints from breccia and slump zones (Fig. 46, C for example) shows that apatite banding follows the contortions and fragmentation with considerable precision. Why has the phosphate not diffused throughout these zones? If these were isolated cases then one could suggest special conditions, but it is clear that wherever phosphate is present in contorted, brecciated or podded zones, the distribution is demonstrably controlled by the original bedding, despite the variety of processes to which the laminations have been subjected.

Migration of phosphate could still account for anomalies such as those in the matching cores from Junction Gorge and the type section, particularly in zones where skeletal apatites and other "late" crystallizing forms are present. The high lateral permeability as opposed to the low vertical permeability of BIF (Dr. T. Parks, CSIRO, pers. comm.) could act as a control for some of the banding, though vertical mobility seems highly unlikely in view of the very marked separation of closely spaced bands throughout the long lengths of phosphate prints available. However, Figure 47, B is an example of a stylolitic contact which fortuitously cuts into a phosphate band. Here we see two different rock types in lateral continuity in a structure formed by a process which assumes solution effects, and yet there is no indication of cross migration of phosphate.

If such a lateral migration does occur then it must be a highly selective process and we are left with the fundamental problem of explaining how such fine details as "phosphate microbanding" can be preserved and why intraformational brecciation and slumping patterns can still be mirrored in the prints without significant signs of diffusion, not just occasionally, but as a general feature of the sediments.

Thus the writer is drawn to the conclusion that the P-banding of these sediments is essentially a primary depositional feature, modified only in a minor way by later processes, chiefly compaction and recrystallization.

To sum up, although there is strong evidence of lateral correlation over a few kilometres for many P-bands there are also many anomalies which are accentuated with distance. Cyclic deposition is convincingly demonstrated for at least one cyclothem sequence, and it would be strange in view of the remarkable stratigraphic correlations across the sediments, if at least some basin-wide phosphate correlations could not be made. On the other hand no evidence has yet been found to suggest that within the Dales Gorge Member, a correlation exists between phosphate and specific lithological types even within the regular cyclothem sequences. The evidence of the phosphate prints suggests that the P-bands reflect a primary depositional control and that they are either laterally discontinuous or more likely, a localized depositional feature.

A SUGGESTED DEPOSITIONAL ORIGIN FOR PHOSPHATE DISTRIBUTION

It has been argued that the phosphate bands reflect a primary depositional control. Any genetic process therefore must explain both erratic and cyclic deposition, and at the same time retain some consistency with the apparently unrelated systematic basin-wide deposition of the sediments.

To do so I suggest, that in general, phosphate influx into the basin was erratic, probably related

to volcanism and differentiation, and perhaps also to temporary openings of the basin to the sea. To some extent the fumarolic activity suggested by Trendall and Blockley (1970) should produce local concentrations of the various constituents in the basin waters. By itself, such a control for local phosphate deposition would imply a similar concentration of other components, and also that the concentration should be restricted to centres of volcanic activity. This is contrary to the evidence of the basin-wide lithological correlations. However if as a result of these temporary concentrations, there was a rapid build up of phosphate-fixing organisms, (analogous to the proliferation of blue-green algae blooms in polluted waters such as Lake Michigan), this might lead to a local phosphate accumulation that did not necessarily have a genetic relationship to the particular matrix being co-precipitated but was nevertheless controlled to some extent by the same general mechanism.* With continued phosphate influx these blooms might extend farther from the source, or as with the other components be dispersed through the basin by currents.

If this idea is acceptable it could be logically extended to multiple volcanic sources of the same type, each producing a varying output as differentiation proceeded. It is not hard to imagine this as a series of unrelated ripples in a pond, interacting to produce highs and lows at different places, and it would not be unreasonable to expect periods of general uniformity consistent with the cyclic patterns such as in column 34. The fine "phosphate microbanding" suggests that a seasonal control was superimposed on the general process, but the hypothesis does not exclude the possibility of direct inorganic precipitation or phosphate exchange between water and carbonate. All three processes acting in concert or separately might have operated to nucleate the variety of apatite forms seen in the sediments. For example, one process may have resulted in the formation of ferrous phosphate such as vivianite, which were subsequently oxidized to give the globular and cigar

* Trendall and Blockley (1970) suggest an algal mat over the basin acting as a buffer between spasmodic influx of matrix components and the regular deposition of BIF.

Figure 46 (opposite)

Photographs of Brockman Iron Formation drill core, with stratigraphically equivalent phosphate stain prints

- A Column 34. Part of BIF 16. Cyclic deposition of phosphate related to the Calamina cyclothem. Trendall and Blockley (1970) suggest a deposition rate of between 1,000 and 3,000 years for each cycle; thus this portion of the column represents a suggested time span of between 9,000 and 27,000 years. The apparently rich phosphate bands at 95 cm are the result of excessive reagent in the strip during printing.
- B Column 42. Joffre Member. This column is fairly typical of the approximately 21 m of Joffre Member core in the exhibit, and shows the dominance of sharply marked phosphate bands in a background of very low phosphate. This distribution is in marked contrast to the very varied Dales Gorge Member prints.
- C Junction Gorge core. Dales Gorge Member, BIF 4, equivalent to approximately 40 m on the type section. The print was prepared from the curved and porous surface of untreated core, but though it lacks the clarity of previous prints shows the phosphate mirroring the contortions and fragmentation in podded and brecciated zones.
- D Part of Column 1 (see Fig. 44). A half-scale reproduction of part of the core used for electron probe studies. The print illustrates the retention of phosphate within the original sedimentary layers, despite the complex post-depositional changes that have produced this podded zone. It should be noted that phosphate and podding are not necessarily associated; see for example, Fig. 45 Column 22, 130 cm.

Figure 47 (over)

Photographs of Brockman Iron Formation drill core, with stratigraphically equivalent phosphate stain prints

- A Lateral correlation of phosphate banding. The two groups of four strips represent, from left to right—phosphate print, Junction Gorge core, type section core, phosphate print, respectively. The matching cores are from the Dales Gorge Member BIF 13 and are marked at 343 feet (104.55 m) and 340 feet (103.63 m) of the type section respectively. The phosphate prints were prepared from the untreated porous surface of the core and show blemishes unrelated to the actual phosphate distribution. The two cores are 80 km apart but show excellent mesoband correspondence at this level. The phosphate distribution however does not show this correspondence and in fact shows many horizons where the distribution is completely reversed. The Junction Gorge core generally shows phosphate in the lighter coloured zones, and though the type section is less regular it is the darker zones that are generally phosphate bearing.
- B Part of an S macroband of the Dales Gorge Member. The structure in the centre of the figure is interpreted as a stylolitic contact cutting into a phosphate band. The absence of diffusion of phosphate across the boundary of laterally adjacent sediments indicates the postdepositional immobility of phosphate.

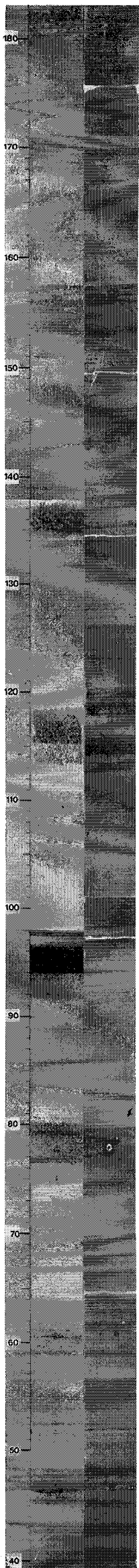

A

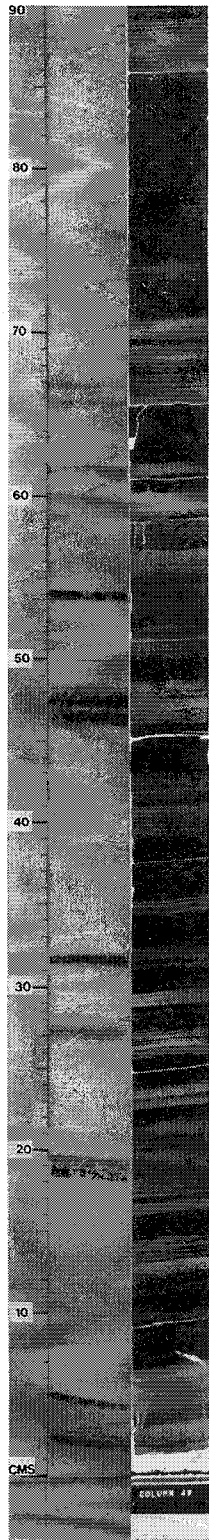

B

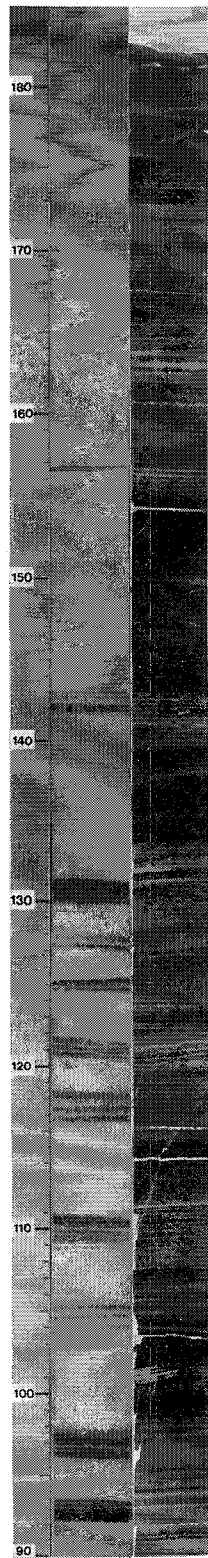
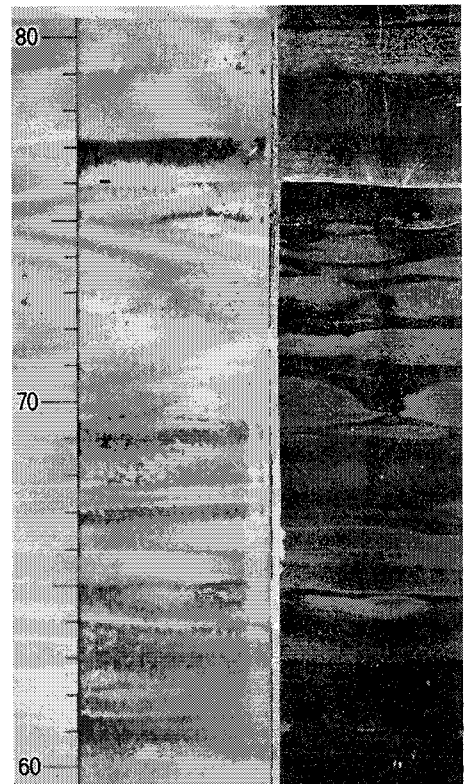
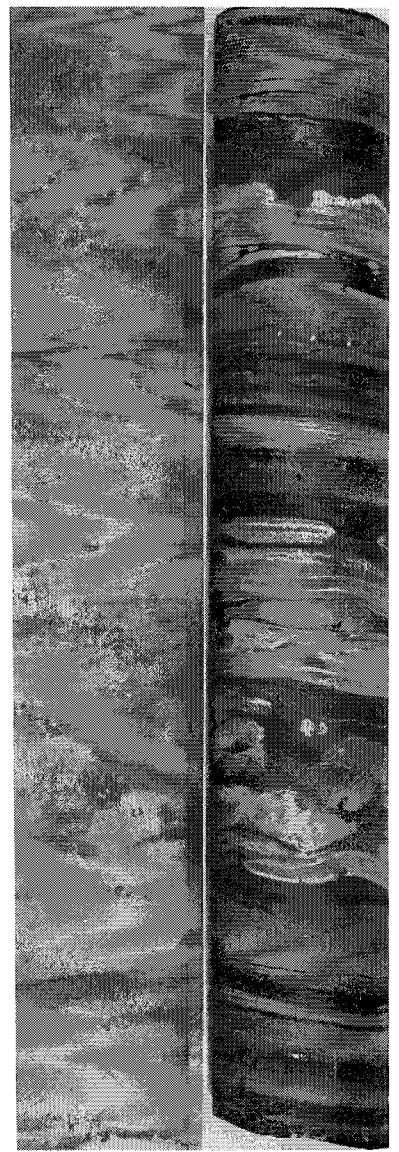

Figure 46



D



C

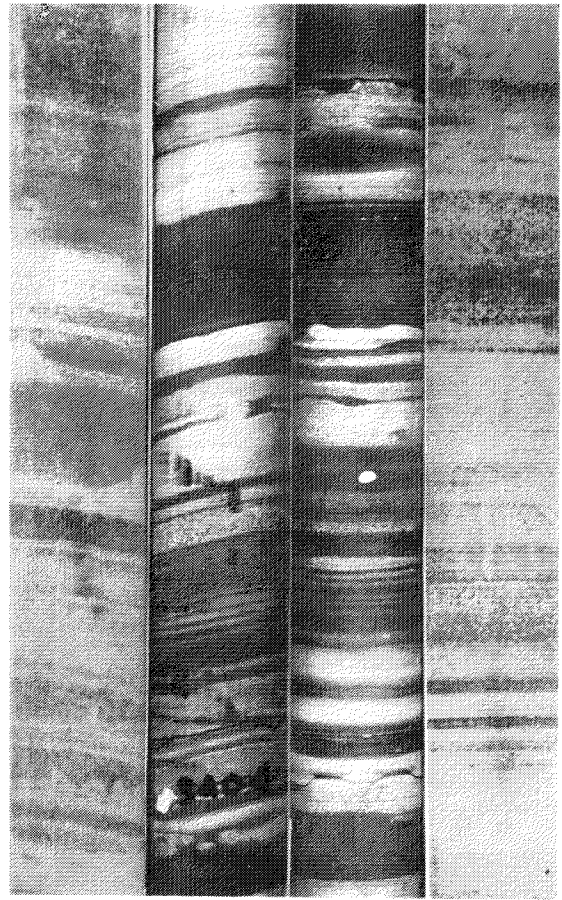
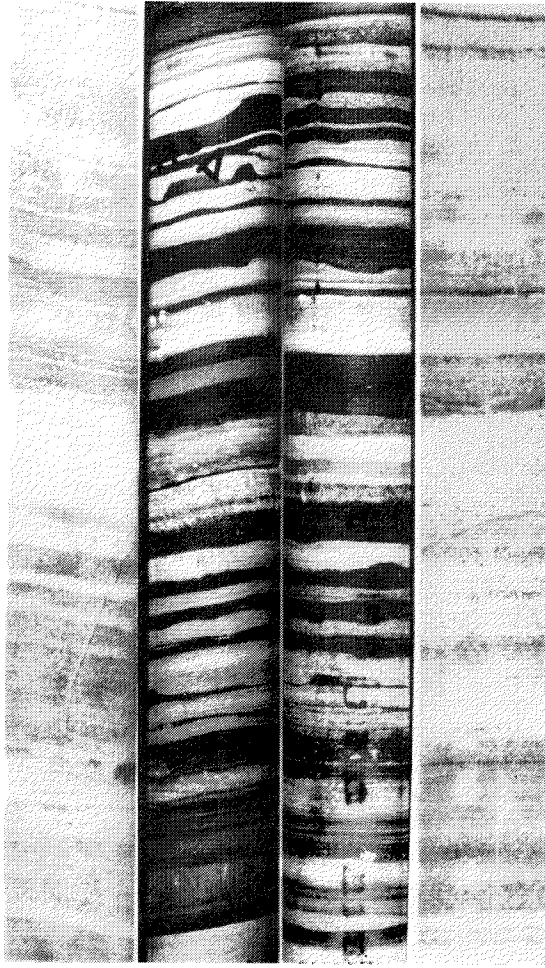

A

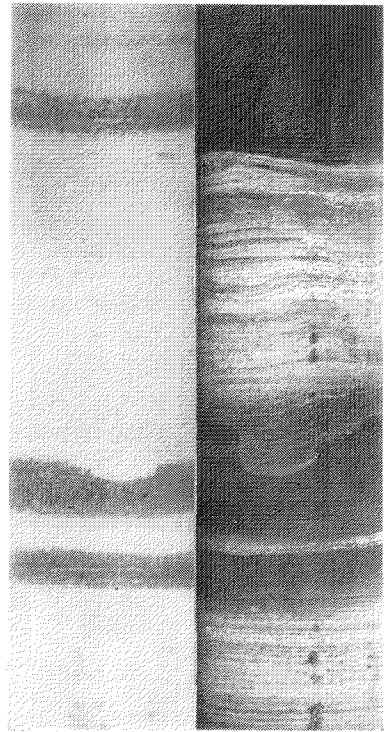

B

Figure 47

A

B

C

D

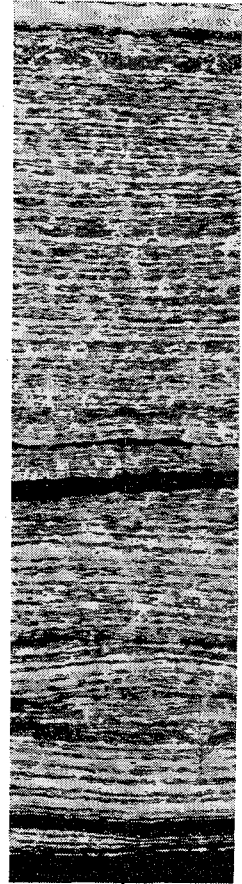
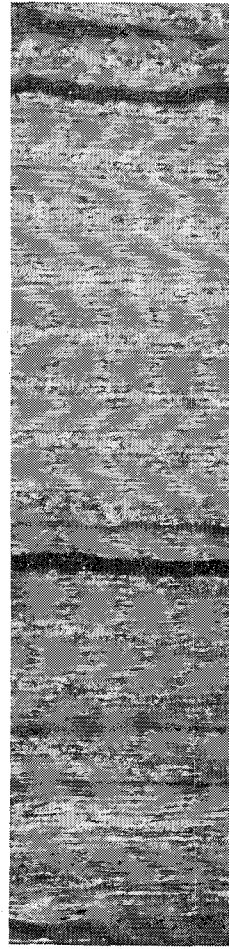
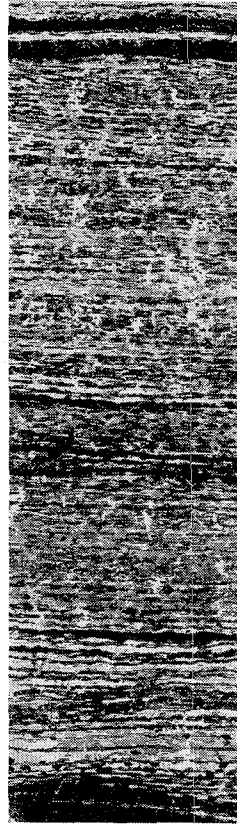
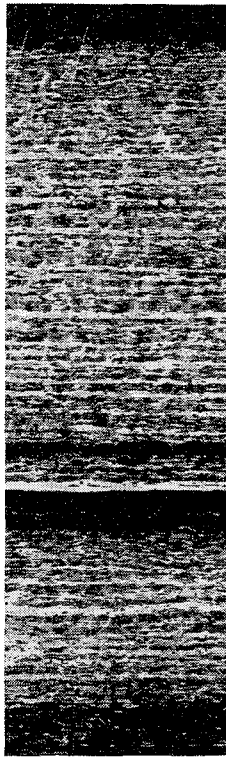

(1)

20 mm

20mm

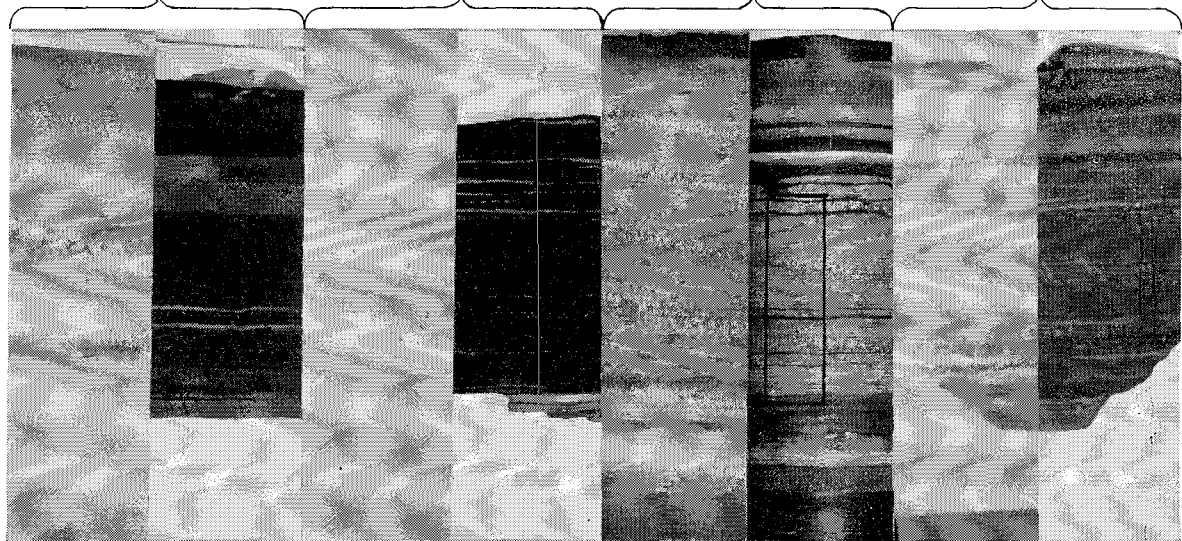

(2)

Figure 48

forms (Fig. 35 of Trendall and Blockley, 1970) with the iron trapped as fine oxide inclusions. Localized recrystallization of phosphate, either together with the matrix minerals or slightly later, could explain the interstitial nature of the skeletal and prismatic apatites, but the minute anhedral spots included within chert and stilpnomelane grains must have been trapped before crystallization of these minerals.

It seems reasonable to suggest an organic origin for much of the phosphate in the banded iron formations, but oxygen isotope studies would clarify this (Degens, 1965). Carbon isotope studies by Becker and Clayton (1972) lead them to suggest an organic origin for much of the carbonate in the Dales Gorge Member and that during the period of formation of this member, the basin was separated from, but located near an ocean. However, they do not rule out volcanism as a source of the "light" carbon in the iron formation.

Finally, one advantage of the planktonic hypothesis is that it is not necessary to invoke new concepts. The process of phosphate induced plant growth in restricted waters, whether from hot springs or detergents, may have been as valid 2,000 million years ago as it is today.

PHOSPHORUS AND THE IRON ORE

One of the chief virtues of the phosphate printing technique is the rapidity with which long lengths of core can be tested, whether in the laboratory or the field. While it cannot, in its present form, be used to test lattice phosphorus of ores such as those described by Graham (in press), it could be readily applied to ores carrying soluble phosphate.

The technique could also be used to provide a rapid semi-quantitative estimate of phosphate in sediments around the known ore bodies, to provide a clue to the relationship between phosphorus in ore and protore.

Figure 48 (opposite)

Phosphate distribution in stratigraphically equivalent samples of the Dales Gorge Member from widely separated areas

- (1) A reproduction of Figure 15, Bull. 119. Trendall and Blockley 1970. Comparison of the chert-magnetite group at about 11.15 to 11.22 m (36.6 to 36.85 ft) in the type section of the Dales Gorge Member (BIF 0) at widely separated localities.
 - A Thin-section from Woongarra Gorge (lat. 22° 52' 30" S, long. 117° 07' 30" E).
 - B Thin-section from Point James (lat. 20° 58' S, long. 117° 07' 30" E).
 - C Surface photograph of the type section from Hole 47A at Witteboom Gorge.
 - D Thin-section from Dales Gorge (lat. 22° 28' S, long. 118° 33' E).

The localities A, B and D form a triangle with sides of length 148, 233, and 298 km. C and D by comparison, only 30.6 km apart. The lateral correlation of internal irregularities of the microbanding below mesoband scale is evident.
- (2) Specimens from which Fig. 48 (1) above prepared, together with matching phosphate prints. A, B and C are polished surfaces and the reproductions show the opaques as light coloured bands and the chert as dark bands. This is the reverse of the thin-section and core reproductions. The rectangle superimposed on C is the area represented by C of Fig. 48 (1). Some correlation of the phosphate distribution can be inferred between C and D but none is apparent between A, B and D. Part of this lack of correspondence may be due to the weathered nature of the polished samples but there are sufficient remnant features to indicate the presence of non-correlative phosphate bands.

ACKNOWLEDGMENTS

I would like to express my appreciation for the co-operation I have received during this project from colleagues in C.S.I.R.O. and from the Director and staff of the G.S.W.A. Among C.S.I.R.O. staff Dr. J. Graham and Mr. R. B. W. Vigers are thanked for help with the probe work, Mr. C. E. S. Davis for his guidance in developing the phosphate print technique and Mr. W. E. Ewers for his initiation and continued support of the project.

Special thanks are due to Mr. L. Fimmell and technical staff of the G.S.W.A. for their help in preparing the samples for study and the stain printing and photographic reproductions from over 100m of drill core. Dr. A. F. Trendall's encouragement and active assistance were essential to the project.

REFERENCES

- Becker, R. H., and Clayton, R. N. 1972, Carbon isotopic evidence for the origin of banded iron formation in Western Australia: *Geochem. et Cosmochim. Acta*, v. 36, p. 577-595.
- Blockley, J. G., 1969, The Stratigraphy of the Mount Tom Price ore body and its implication in the genesis of iron ore: *West. Australia Geol. Survey Ann. Rept.* 1968, p. 49-50.
- Bonatti, E., Fisher, D. E., Joensuu, O., and Rydell, H. S., 1971, Postdepositional mobility of some transition elements, phosphorus, uranium and thorium in deep sea sediments: *Geochem. et Cosmochim. Acta*, v. 35 p. 189-201.
- Cloud, P. E., 1968, Atmospheric and hydrospheric evolution on the primitive earth: *Science*, v. 160, p. 729-736.
- Degens, Egon, T., 1965, *Geochemistry of Sediments*: Prentice-Hall Inc.
- Graham, J., in press, Phosphorus in iron ores from the Hamersley Iron Formations: *Australasian Inst. Mining and Metall. Proc.*
- MacLeod, W. N., 1966, The geology and iron deposits of the Hamersley Range area, Western Australia: *West. Australia Geol. Survey Bull.* 117.
- MacLeod, W. N., de la Hunty, L. E., Jones, W. R., and Halligan, R., 1963, A preliminary report on the Hamersley Iron Province, North-West Division: *West. Australia Geol. Survey Ann. Rept.* 1962, p. 44-54.
- Murphy, J., and Riley, J. P., 1962, A modified single solution method for the determination of phosphate in natural waters: *Analytica Chimica Acta*, v. 27, p. 31-36.
- Trendall, A. F., and Blockley, J. G., 1968, Stratigraphy of the Dales Gorge Member of the Brockman Iron Formation, in the Precambrian Hamersley Group of Western Australia: *West. Australia Geol. Survey Ann. Rept.* 1967, p. 48-53.
- 1970, The iron formations of the Precambrian Hamersley Group, Western Australia: *West. Australia Geol. Survey Bull.* 119.
- Williams, D., and Nakhla, F. M., 1951, Chromatographic contact print method of examining metallic minerals and its applications: *Inst. Mining and Metall. Bull.* 60, p. 257-295.

THE GEOLOGY OF THE FITZGERALD RIVER LIGNITE

by A. E. Cockbain and W. J. E. van de Graaff

ABSTRACT

The area consists of a plateau dissected by the Fitzgerald and Susetta Rivers and is situated around the junction of these two rivers. Over most of the area the Eocene Plantagenet Group, consisting of the lower, lignite-bearing Werillup Formation and the upper, spongolite-bearing Pallinup Siltstone, unconformably overlies Precambrian quartzites and phyllites (Mount Barren Beds) or granite. The Pallinup Siltstone forms most of the plateau; the valleys are underlain by the Werillup Formation

with a few Precambrian inliers and are floored by alluvium. Lignite lenses and flakes are present throughout the Werillup Formation and are also concentrated in a bed about 3 m thick which occurs near the junction of the Fitzgerald and Susetta Rivers. It is estimated that about 1.1 million t of lignite averaging 2.3 per cent. (dry basis, benzene extraction) montan wax is present. On a wet basis this gives a figure of about 15,000 t of montan wax occurring in the Fitzgerald River lignite. The wax has a lower melting point and higher resin content than German or Californian waxes.

INTRODUCTION

The area covered in this paper lies some 50 km east-southeast of Jerramungup and is about 520 km by road from Perth (Fig. 49). It includes part of the Fitzgerald River and its tributaries the Susetta River, Twertup Creek and Tooartup Creek. Geologically it is part of the Bremer Basin.

This study was undertaken because of proposals to explore for and mine lignite occurring in the area for its extractable montan wax. As the area of interest is situated in a flora and fauna reserve the question of mining and exploration was referred to the Environmental Protection Authority. This paper is a summary of work done at the request of the Environmental Protection Authority and gives an account of the geology of the Fitzgerald River lignite.

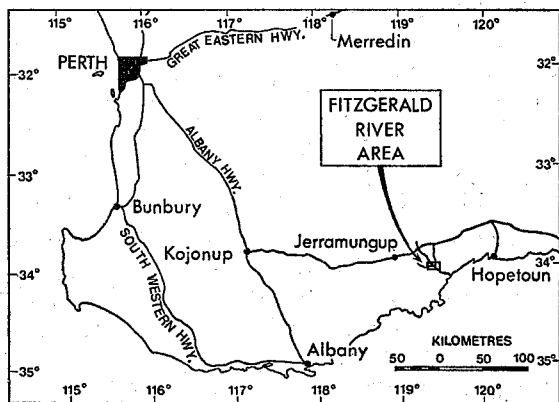

Figure 49. Fitzgerald River area—locality map.

PREVIOUS WORK

Lignite was first discovered in the Fitzgerald River area by the Surveyor-General, J. S. Roe, in 1848 (Roe, 1852). The lignite was described as containing elongated globules of bitumen "... from the size of a pea to that of a goose egg ..." (Roe, 1852, p. 36). The lignite bed was horizontal but the adjoining shales were reported to have a dip of 45°. Roe also recorded that according to a local Aboriginal, a French ship had refuelled from coal occurring in the Fitzgerald Inlet. He was of the opinion that the deposit would be a valuable source of fuel for the colony. Gregory (1861) discussed the lignite under the heading "Carboniferous Rocks" and stated that the bed is horizontal "... resting unconformably upon the edges of highly elevated Carboniferous shales, and contains many distinct fragments of only semi-fossilized wood and pieces of infusible resin ..." (Gregory, 1861, p. 480).

Both Roe and Gregory persisted in calling the lignite "coal" and tacitly assumed that it was Carboniferous in age. However, Dixon (1884) recognized that "... the supposed coal was nothing but a few very thin beds of brown lignite ..." (Dixon, 1884, p. 9) and was probably of the same age as the sandstones through which the Fitzgerald River flowed. He also noted that the lignite rested on "... metamorphic sandstones, jaspers and micaceous schists ..." and not on Carboniferous shales as Gregory thought. Nicolay (1876, 1886) could find no indications of Carboniferous rocks and stated that there was no coal present in the area, but only a deposit 1.5 m thick "... of a mineral termed by the French 'turba' ..." (Nicolay, 1886, p. 7) by which he presumably meant peat.

Woodward (1890) examined the area and considered the lignite "... to be nothing more than a brown carbonaceous substance, containing a certain amount of asphaltum ... it is not a coal, and will never be of any commercial value as a fuel", (Woodward, 1890, p. 50). He recognized that the deposits occur in hollows on the upturned edges of altered slates and quartz reefs.

No further geological work was done in the area until 1921 when an exploratory well (herein named Jonacoanack No. 1) was drilled for petroleum. Jonacoanack No. 1 was drilled to a depth of 108 m through Precambrian quartzites and phyllites of the Mount Barren Beds (see Maitland, 1922, and

appendices therein for details). A brief summary of the lignite occurrence in the Fitzgerald River area was given by Maitland (1922) who reported that two bores had been drilled in the area "... one is said to be 216 and the other 397 feet deep. These are stated to have passed through two seams of lignite 16 and 18 feet in thickness. The site, however, of only one of the bores in question has been located on a plan and there is neither record nor samples available of the rocks pierced" (Maitland, 1922, p. 14). Simpson (in Maitland, 1922) established that the rounded nodules (Roe's globules) were not bituminous, but a resin of vegetable origin.

In 1928, interest in the lignite was revived, mainly as a source of crude oil by destructive distillation (Blatchford, 1929). Wheeler's Shaft, on the Fitzgerald River, and a bore 1.5 km downstream, were sited on or near lignite outcrops and penetrated 2.9 m and 2.4 m of lignite respectively. A second bore some 300 m up the Susetta River was not near any known outcrop and was reported as failing to reach the lignite. Blatchford gave analyses of the lignite and produced a map showing the position of two bores labelled "Dunstan's Bore" and "Old Bore" which are presumably the bores referred to by Maitland in 1922. In addition, Blatchford reported the presence of blocks of lignite upstream from the drilled area near the junction of the Fitzgerald River and Twertup Creek. He concluded that there was "... an extensive deposit of brown coal, more or less proved ..." (Blatchford, 1929, p. 6).

Later Blatchford (1930) referred to the lignite-bearing beds as the "Fitzgerald Brown Coal Series" and assigned them to the Miocene. Cockbain (1968) recommended the abandonment of this name on the grounds that it was never adequately defined; he placed the lignite in the Werillup Formation of the Plantagenet Group, which is of Eocene age. He also gave a summary of work on the Phanerozoic sediments of the Bremer Basin ("Denmark-Esperance region" of his paper) and formalized the stratigraphic nomenclature of the Plantagenet Group.

METHODS OF STUDY

The present study commenced with a field reconnaissance of the area made from the 6th to 11th September, 1972. A preliminary report and a geological map on a scale of 1:30,000 were prepared as a result of this work (Geological Survey File 181/63) and a drilling programme was recommended. The drilling programme was to consist initially of 12 holes (later increased to 15), and if this indicated that the lignite was widespread it was to be followed by a second-stage programme with a network of holes.

The drilling started on 13th November and was completed on 30th November. A gemcodril 210B auger drill with a wireline coring device was used. A total of 261.4 m of hole was drilled and 74 cores were cut. Of the 15 holes, three were drilled twice and two were drilled three times because of either drilling difficulties or non-recovery of core in vital parts of the Werillup Formation. The position and elevation of all drillholes were surveyed by means of a plane table and telescopic alidade. Datum for the elevations is ground level at the easternmost lignite outcrop in the area which occurs in the bed of the Fitzgerald River east of drillhole N.

GEOMORPHOLOGY

The Fitzgerald River area (Fig. 50) consists of a plateau dissected by broad river valleys which have steep sides and gently sloping floors. The plateau is about 150 m above sea level and is underlain by Tertiary (Eocene) sediments. The present-day river channels have cut down into the broad valley floors, which are underlain mainly by alluvium through which a few buried mounds of Precambrian rocks appear. The scarps at the edges of the valleys are up to 50m high. There are indications in places, for example on the west side of the Fitzgerald River north of the junction with Twertup Creek, of at least three sets of river terraces. In and beyond the southeast part of the area the Fitzgerald River cuts through Precambrian rocks and there is no extensive alluvial cover.

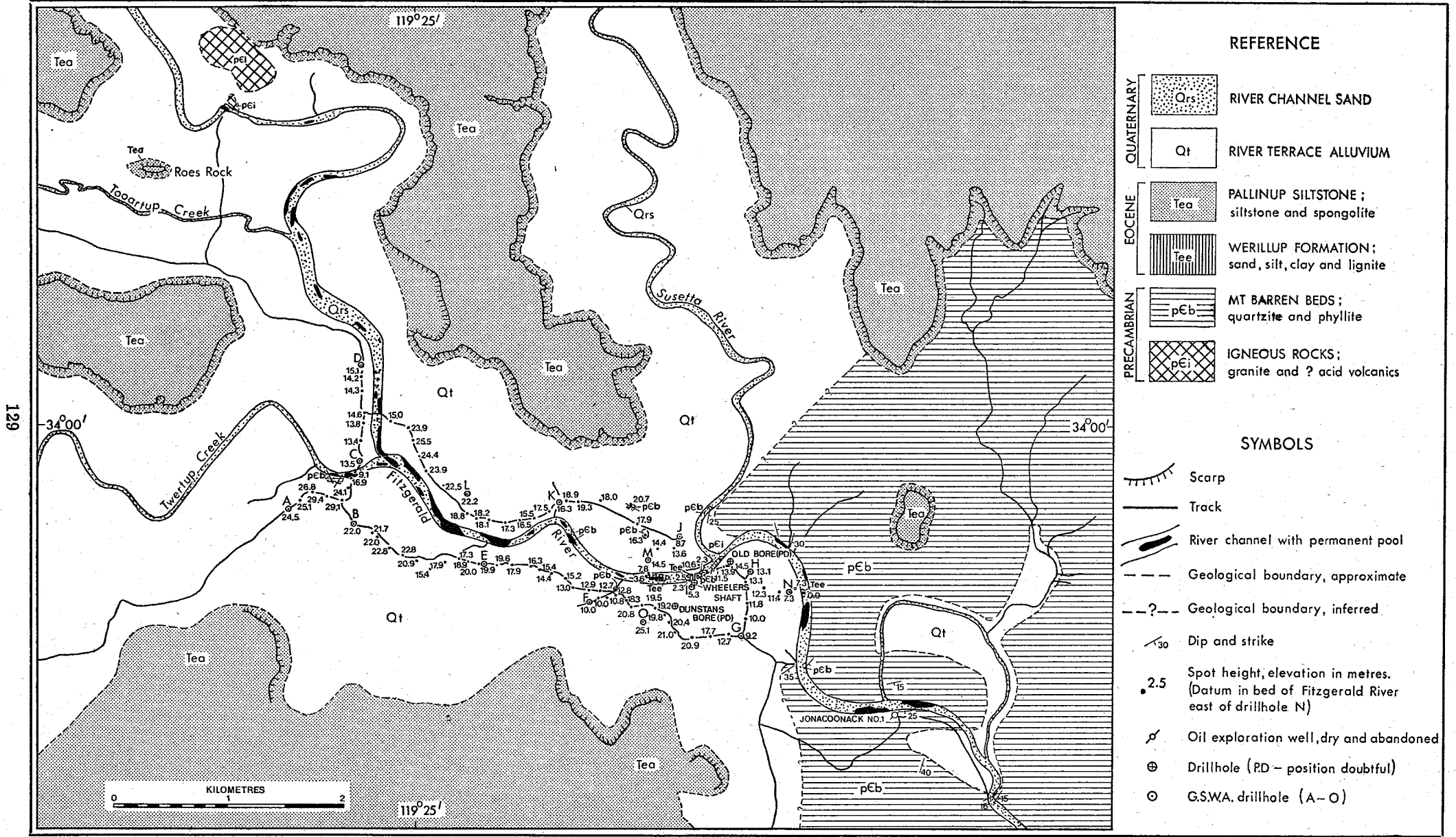

Figure 50. Geological map—Fitzgerald River area.

GEOLOGY

The stratigraphic succession in the Fitzgerald River area is as follows:

Quaternary	River-channel sands River-terrace alluvium	-----	at least 12.5 m thick
		Pallinup Siltstone up to 60 m thick
Plantagenet Group	Werillup Formation	-----	at least 24 m thick

Precambrian { Mount Barren Beds ----- thickness
Granite unknown

Figure 50 is a geological map of the area, and also shows the position of the drillholes and some elevation data. Geological logs of the drillholes are on file at the Geological Survey and are summarized in Table 23 and Figure 51. Cross-sections in the form of a fence diagram are presented in Figure 52.

TABLE 23. SUMMARY OF DRILLHOLE DATA

Drillhole	A		B		C		D		E		F		G		H	
Ground Elevation (see text for datum)	24.5		22.0		13.5		15.1		19.9		10.0		9.2		13.1	
Formation (formation tops below R.T. and relative to datum)	R.T.	Datum	R.T.	Datum	R.T.	Datum	R.T.	Datum	R.T.	Datum	R.T.	Datum	R.T.	Datum	R.T.	Datum
Alluvium	0.5	24.5	0.5	22.0	0.5	13.5	0.5	15.1	0.5	19.9	0.5	10.0	0.5	9.2	0.5	13.1
Pallinup Siltstone
Werillup Formation	5.5	14.9	1.1	9.4	5.1	4.6	8.5	5.1
Precambrian	8.5	16.5	4.6	17.8	12.0	2.0	9.1	6.5	18.6	-8.2	8.6	1.1	13.0	0.6
T.D.	12.1	12.9	7.5	15.0	12.5	1.5	13.6	2.0	28.8	-8.4	21.0	-10.5	9.0	0.7	18.9	-5.3

Drillhole	I		J		K		L		M		N		O	
Ground Elevation (see text for datum)	5.3		8.7		16.3		22.2		14.5		7.3		25.1	
Formation (formation tops below R.T. and relative to datum)	R.T.	Datum	R.T.	Datum	R.T.	Datum	R.T.	Datum	R.T.	Datum	R.T.	Datum	R.T.	Datum
Alluvium	0.5	5.3	0.5	8.7	0.5	16.3	0.5	22.2	0.5	14.5	0.5	7.3	0.5	25.1
Pallinup Siltstone
Werillup Formation	3.5	2.3	4.4	12.4	11.3	11.4	11.7	3.3	6.3	1.5	12.6	13.0
Precambrian	17.1	-11.3	2.1	7.1	28.5	-11.7	30.6	-7.9	20.0	-5.0	20.0	-12.2	14.1	11.5
T.D.	17.5	-11.7	2.9	6.3	29.0	-12.2	31.3	-8.6	21.8	-6.8	21.2	-13.4	14.3	11.3

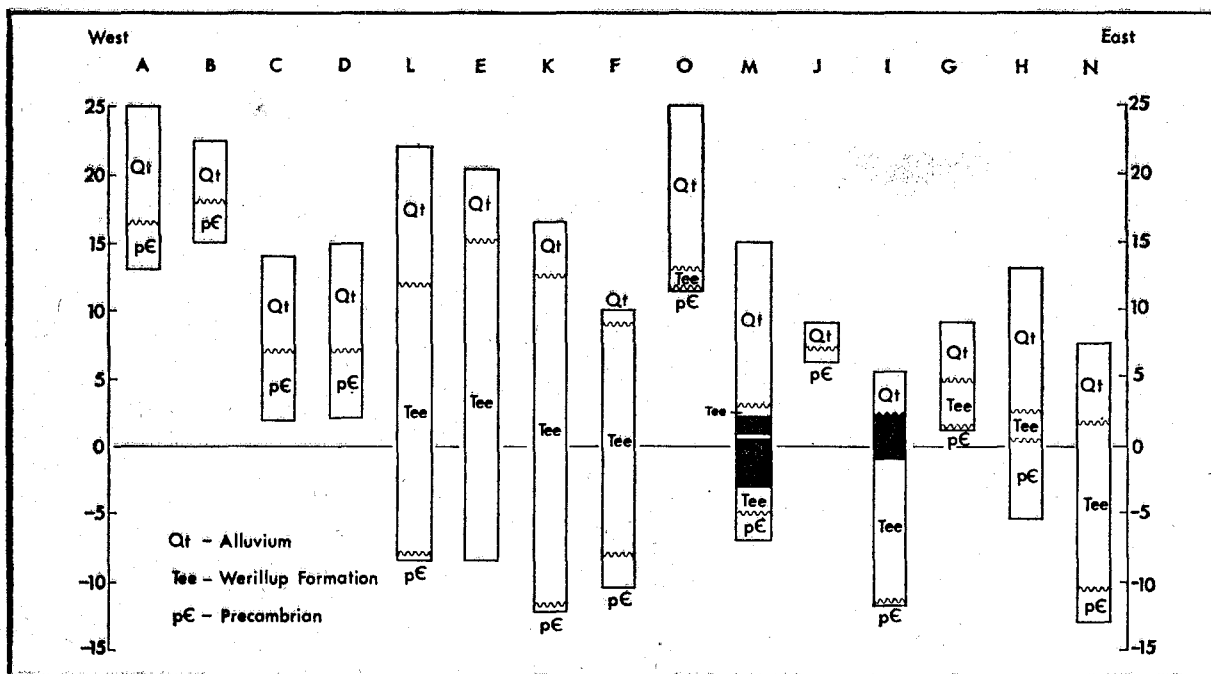
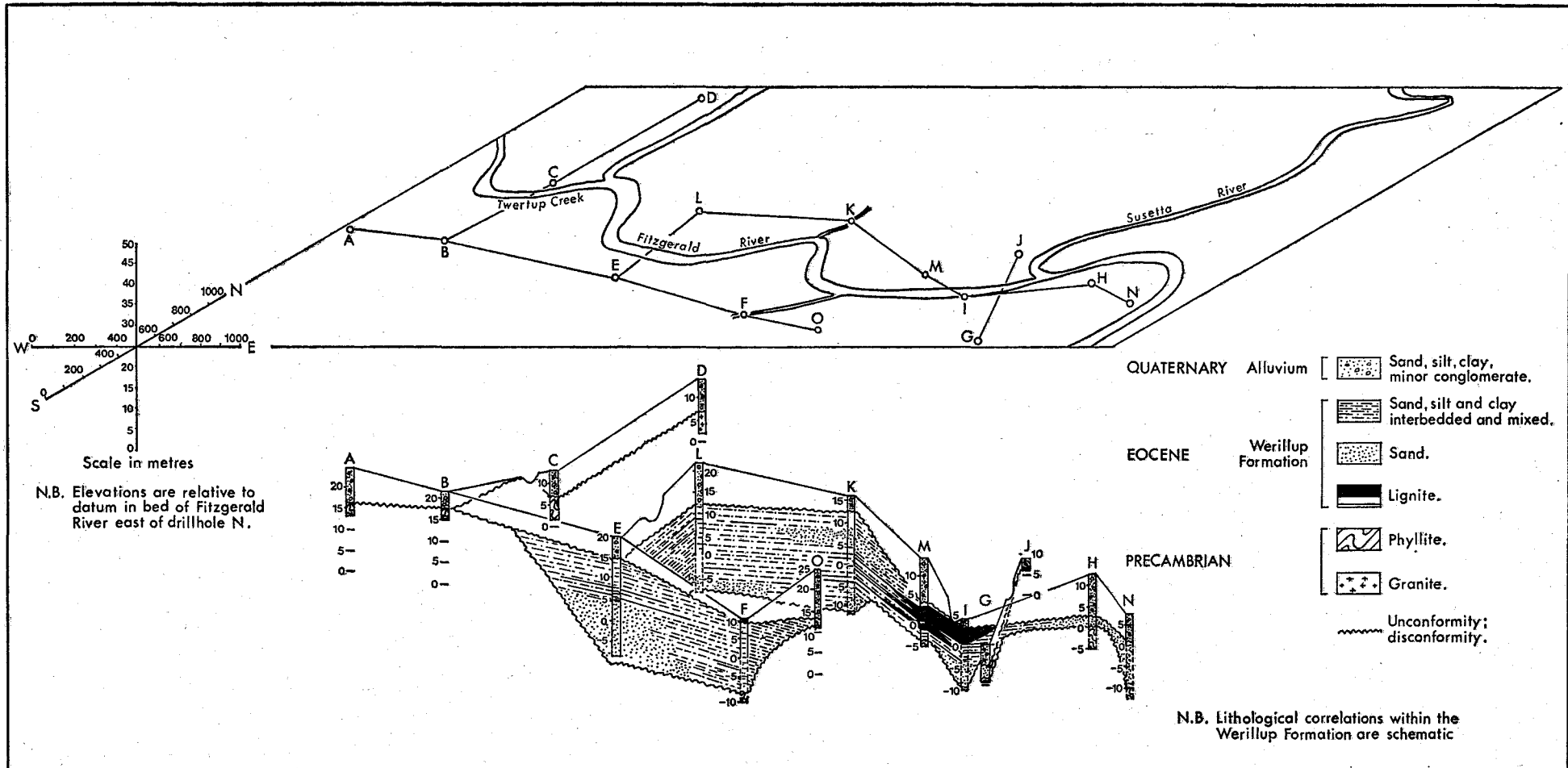

Figure 51. Stratigraphic correlation of drillholes and distribution of lignite (in black). Elevations are relative to datum in bed of Fitzgerald River east of drillhole N.

Figure 52. Fence diagram showing correlation of drillholes.



PRECAMBRIAN ROCKS

The Precambrian rocks consist mainly of granite in the north and quartzites and phyllites of the Mount Barren Beds in the south. The relationship between the two Precambrian units cannot be determined in the area studied; the Mount Barren Beds are considered to be Proterozoic in age and the granite is presumed to be of Archaean age.

The granite has been examined only in the area north of Roes Rock where it is coarse grained, contains a few clots of mafic minerals, is slightly banded, but is otherwise structureless. Weathered granitic material was encountered at the base of drillhole D and granite must extend at least this far south.

The Mount Barren Beds are the basement rocks over most of the Fitzgerald River area. They consist of pale grey to green phyllites, which are often soapy to the touch, and subordinate white quartzite beds. Both dip and strike are variable, but the beds usually dip in a general southeasterly direction at 15 to 40°. The Mount Barren Beds occur in scattered outcrops along the Fitzgerald and Susetta river valleys; the best exposures are along the Fitzgerald River in the vicinity of Jonacoona No. 1 well. The formation was encountered in all drillholes except D and E. Drillhole E did not reach basement and D encountered weathered granite. Drillhole H bottomed in phyllite with minor intercalations of an igneous rock similar to that occurring in the adjacent Fitzgerald River. This igneous rock has been identified as an acid volcanic rock (J. D. Lewis, 1972, pers. comm.); the relationship of these volcanic rocks with the Mount Barren Beds is uncertain.

PLANTAGENET GROUP

The Plantagenet Group consists of a lower dark coloured lignite-bearing unit, the Werillup Formation, and an upper light coloured, spongolite-bearing unit, the Pallinup Siltstone (Cockbain, 1968).

The group is horizontal and rests on a basement surface of considerable relief. North of Roes Rock a hill of granite rises 50 m above river level, while some 6 km to the southeast basement is encountered about 13 m below datum level in drillhole I;

taking into account the gradient of the river this gives a relief on the basement surface of about 80 m in the area mapped. Figure 51 gives an idea of the irregularity of the basement surface in the area drilled. The Werillup Formation occupies hollows in the basement surface and is overlapped by the Pallinup Siltstone which then rests directly on basement, for example around the granite hills north of Roes Rock.

Werillup Formation

The Werillup Formation consists of dark brown to black clay, loose sand to friable sandstone (occasionally pyritic) and lignite. The formation crops out in only two places: (a) upstream from the junction of the Fitzgerald and Susetta Rivers and (b) 1.5 km downstream from the junction of these two rivers.

Outcrop (a) is the lignite exposure near which Wheeler's Shaft was sunk in 1928. Here the lignite is black to dark brown with recognizable plant remains (mainly stems) and little terrigenous material; it has an exposed thickness of about 1 m and forms a small waterfall. Blatchford (1929) recorded 2.9 m of lignite in Wheeler's Shaft and the nearby drillholes I and M penetrated 3 m and about 4 m of lignite respectively. Upstream from the waterfall the lignite can be traced for about 200 m, but is discontinuously exposed beneath river-channel sands; the amount of lignite exposed depending on the amount of sand removed by river floods. Present exposures are more extensive than those of recent years (M. Foggarty, 1972, pers. comm.). The outcrop extends downstream for about 75 m and in this distance passes laterally into dark brown clay and sand with lignitic interbeds. Outcrop (b) is probably the original outcrop discovered by Roe in 1848. It consists of black to dark brown brittle impure lignite with quartz grains up to 1 cm in diameter, and occurs in the river bed. According to Blatchford (1929) a bore drilled near here penetrated 2.4 m of lignite.

The Werillup Formation was encountered in all drillholes except A, B, C, D, and J, and is restricted to the valley of the Fitzgerald River between its confluence with the Twertup and the Susetta (Fig 53). Blatchford's (1929) report of lignite blocks at the junction of the Fitzgerald

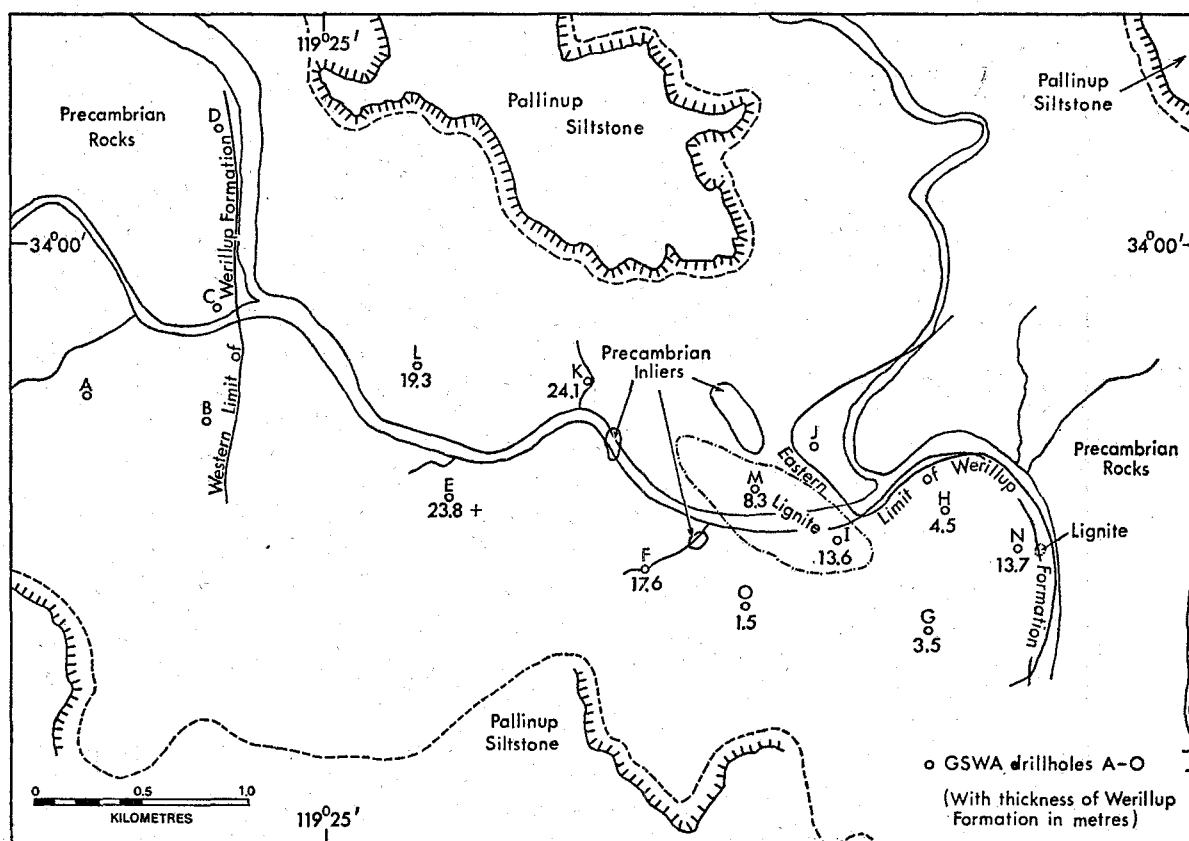

Figure 53. Areal extent of Werillup Formation beneath river-terrace alluvium.

River and Twertup Creek was not confirmed. The formation has a maximum known thickness in the area of 24.1 m (in drillhole K) but shows rapid changes in thickness over a short distance (see Figs. 51 and 52). Only two drillholes, I and M, penetrated a bed of lignite of more than a few centimetres thickness; the remaining eight drillholes in the Werillup Formation went through a sequence of dark coloured sand and clay with or without minor lignite lenses and flakes (Figs. 51 and 52). Lithologically the formation varies both laterally and vertically as can be seen from Figure 52. However, there appears to be a general sequence of sandy beds at the base followed by clayey strata. Lignite is developed within the clays, and the drillholes show that only one lignite bed is present in the area, at about river level, and that the bed does not extend far beyond the known outcrop.

The Werillup Formation is of Late Eocene age (Cockbain, 1968). In the Fitzgerald River area palynological work (Appendix 2) cannot date the formation more precisely than Early Tertiary.

Pallinup Siltstone

The Pallinup Siltstone consists of pale brown to creamy white siltstone and spongolite. The unit forms spectacular mesa topography, well exemplified by Roes Rock, but is not present in the floor of the river valleys and was not encountered in any of the drillholes. The maximum thickness of the Pallinup Siltstone in the area mapped is of the order of 60 m. Cockbain (1968) gives further details of the formation.

RIVER-TERRACE ALLUVIUM

River-terrace alluvium, arbitrarily assigned to the Quaternary, underlies most of the floor of the river valleys and was penetrated in all the drillholes. The unit consists of light grey, poorly sorted sand and clay with pebbles of quartzite and spongolite. In places, particularly at the edge of small stream channels, the alluvium is indurated and ferruginized; this induration is very local in distribution and was only encountered in two drillholes, J and N.

The alluvium rests on an uneven erosion surface which cuts across the underlying formations. The elevation of this surface ranges in the drillholes from +18 m (in D) to +1.6 m (in N) (Fig. 51). Erosion has cut into the upper part of the Werillup Formation, and at drillhole I and adjacent outcrops in the bed of the Fitzgerald River it can be shown that the top of the lignite has been eroded away. The maximum measured thickness of alluvium is in drillhole O, where 12.5 m was penetrated.

The alluvium was formed by the rivers in the area dumping their sedimentary load and building up the valley floor. This must have occurred during a period of greater rainfall than at present and after a time of vigorous erosion which produced the broad valleys cut through the plateau of Plantagenet Group sediments. At least three different river-terrace levels occur in the area; no attempt has been made to map these terraces, but they must indicate a fairly complex Quaternary history for the area.

RIVER-CHANNEL SANDS

The present day river channel is cut into the alluvium and is floored by outcrops of pre-Quaternary rock units and by Recent river-channel sand. This sand is reworked alluvium and its distribution changes from time to time and is controlled by the infrequent river floods.

DISTRIBUTION OF LIGNITE

The lignite occurs in the Werillup Formation, and its distribution is consequently determined by the areal extent of that formation. However, three other factors also affect the distribution of the lignite (Fig. 54):

- (1) Lateral facies change within the Werillup Formation. Only one bed of lignite, present near the top of the Werillup Formation, occurs in the Fitzgerald River area. Both drilling and examination of outcrops show that the bed is restricted in its areal extent and passes laterally into sand and clay with lignite fragments.
- (2) Uneven basement surface. The Werillup Formation was laid down on an uneven basement surface and occupies hollows in this surface. In places, for example 100 m downstream from Wheeler's Shaft, basement rock crops out at or above the elevation of the lignite bed.
- (3) Erosion surface at base of alluvium. Erosion has cut down into the upper part of the Werillup Formation and removed the top of the lignite bed in the vicinity of drill-hole I.

The area underlain by the Werillup Formation, as determined by field mapping and drilling, is shown in Figure 53. Lignite is present in only the eastern portion of this area and is centred around the known outcrops. The lignite encountered in drillholes I and M forms part of the larger of the two occurrences; the boundary of this occurrence has been drawn using both drillhole and outcrop evidence. The other lignite occurrence, east of drillhole N, is based on the outcrop in the river bed and Blatchford's (1929) statement that the bed is 2.4 m thick in a bore near here. However, the field relationships and drilling, especially drillholes H and N, show that the occurrence must be very small.

The overburden ratio in drillhole M is about 1 : 4. Obviously this ratio will increase towards the edge of the area underlain by lignite due to thinning of the lignite bed, and will be lowest in the river bed where the lignite crops out.

It is suggested that in the Fitzgerald River area the Werillup Formation was laid down in a small basin roughly co-extensive with the area shown in Figure 53. Sand and clay were brought into the basin by a river flowing from the west. Swamp conditions were established, and peat accumulated in the downstream part of the basin; upstream the river built up a sandy delta. The basin may have been near sea level as some of the sands show marine influence. The result of this pattern of conditions was to produce a fluvial-lacustrine deposit with sand and clay in the upstream (western) part and sand, clay and lignite downstream (to the east). If this picture is correct it implies that

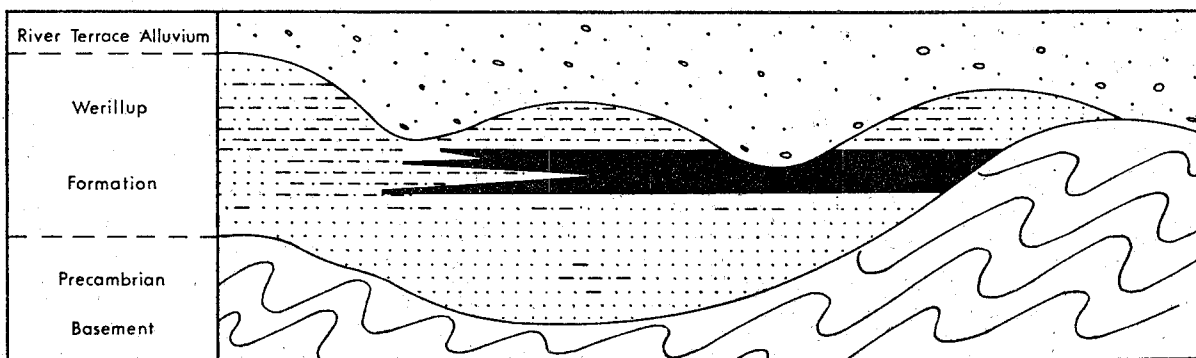

Figure 54. Diagram showing factors affecting distribution of lignite (symbols as in Figure 52).

the presence of other occurrences of lignite in the immediate neighbourhood is unlikely; similar small basins may occur in the surrounding area but they are probably concealed under several tens of metres of Fallinup Siltstone and could only be found by drilling.

PROPERTIES OF LIGNITE

In this report the term lignite is used for a consolidated member of the coal series with more than 30 per cent moisture and a moist calorific value of less than 19.3 MJ/kg (Lord, 1952). The following properties will be discussed:

- (1) Specific gravity
- (2) Proximate analysis
- (3) Calorific value
- (4) Crude oil content
- (5) Montan wax content and quality.

All analyses of samples collected during this investigation have been made by the Government Chemical Laboratories and are given in full in Appendix 1.

1. Specific Gravity. Specific gravity was determined by displacement of water and was measured on the samples as received. Values ranged from 1.17 to 1.49 with the average being 1.3.

2. Proximate analysis. Proximate analyses of Fitzgerald River lignite have been published previously by Wilson (in Maitland, 1922) and Blatchford (1929). These analyses, together with ones obtained during this study are summarized in Table 24, where they can be compared with proximate analyses of lignites from California and Victoria. The Fitzgerald River lignite is characteristically high in moisture and ash.

TABLE 24A. PROXIMATE ANALYSES, GROSS CALORIFIC VALUE AND CRUDE OIL CONTENT OF VARIOUS LIGNITES

Lignite Sample	Proximate Analyses				Gross Calorific Value* (MJ/kg)
	Moisture	Volatile Matter	Fixed Carbon	Ash	
Ione Formation, California (a)					
American Lignite Products mine	36.8	36.8	16.2	10.2	16.40
Edwin No. 2 mine	37.3	32.9	21.4	8.4	14.59
Victoria Brown Coal (b)					
Yallourn	66.3	17.7	15.3	0.7	8.71
Tanjil East	50.0	26.0	22.0	2.0	12.95
Fitzgerald River Lignite					
Drillhole I, top of bed	50.1	19.9	13.2	16.8	8.95
base of bed	52.4	19.1	13.4	15.1	9.25
Drillhole M, top of bed	56.8	21.6	15.1	6.5	10.59
base of bed	38.6	12.5	6.4	42.5	5.59
Wheeler's Shaft (c)					
top of bed 2.4-2.9 m	37.6	32.4	18.2	11.8	
1.8-2.4 m	42.5	27.7	17.3	12.6	
1.2-1.8 m	42.2	30.1	17.5	10.1	
61 cm-1.2 m	42.3	26.8	14.5	16.4	
base of bed 0-61 cm	33.1	24.8	14.2	27.9	
Drive near bottom of Wheeler's Shaft (c)					
top, over 84 cm	42.9	28.3	16.4	12.4	
base, over 84 cm	43.4	23.5	14.6	18.5	
Bore 1.6 km downstream from Wheeler's Shaft (c)					
	15.7	7.7	3.6	73.0	
Near junction of Fitzgerald and Susetta Rivers (d)					
	7.9	54.0	21.4	16.7	

- * As received.
(a) Selvig and others, 1950
(b) Edwards, 1945
(c) Blatchford, 1929
(d) Maitland, 1922

TABLE 24B.

Lignite Sample	Crude Oil (bbbls/tonne)
New South Wales oil shale (a)	
Capertee Valley, Permian coal measures	1.4-2.8
Marangaroo torbanite, Permian coal measures	6.8 (max.)
Queensland oil shale (a)	
Carnarvon Creek torbanite, Permian	0.9
Injuhe, Jurassic coal measures	0.7-1.3
Baffle Creek, Tertiary	up to 1.3
Fitzgerald River lignite (b)	
Wheeler's Shaft	0.3

- (a) Turner, in MacLeod, 1966
(b) Blatchford, 1929

3. Calorific value. No figures for calorific value have been previously available for the Fitzgerald River lignite. The gross calorific value ranges from 5.59 to 10.59 MJ/kg; as may be seen from Table 24 these values are low when compared with Californian lignite, but about the same as the Victorian lignites.

4. Crude oil content. Blatchford (1929) gives figures for the crude oil extracted from lignite samples obtained from a drive near the bottom of Wheeler's Shaft. The average value is 0.3 barrels/t which is low compared to Australian oil shales (see Table 24).

5. Montan wax content and properties. The Government Chemical Laboratories supplied the following information on montan wax:

"The term 'montan wax' applies in its restricted sense to the particular extraction of central German lignites. The term 'montana wax' is used in the broader sense to describe waxes extracted from lignites found in many parts of the world. These waxes, according to their origin, differ somewhat in the proportional make-up of the constituents but are quite similar in most respects to true montan wax.

"All crude montan or montana waxes contain three main constituents—resins, ester waxes and asphalt and they differ from each other in containing different amounts of each. Benzene extracts a crude wax containing resins, ester wax and some asphaltic material. Hexane extracts all the ester wax fraction with some resin but no asphalt. Benzene/alcohol azeotrope extracts resins, ester wax and much asphaltic material. The yield of crude wax extracted by benzene/alcohol azeotrope exceeds that of benzene which in turn is greater than the hexane yield. Xylol behaves similarly to benzene but gives slightly higher yields because of its higher boiling temperature.

"The resins form a group of substances of very complex and variable chemistry and the resin content of the various crude montan waxes depends on both the source of the lignite and the solvent used to extract the wax. The resin (inclusive of the asphalt) is generally the undesirable constituent of the crude wax and this usually means that to be widely suitable for commerce the wax must be purified to a more or less resin-free state containing less than about 10 per cent resin. However if the crude wax has suitable melting point and other physical characteristics such as hardness, surface gloss etc. it may well be a commercial proposition in the crude form regardless of high resin content.

"Montan waxes are composed of a mixture of chemical constituents and so do not have a sharp melting point but rather they melt over a range of several degrees of temperature to dark viscous liquids. The melting range of a benzene/alcohol extract is usually several degrees higher and broader than that of the corresponding benzene extract. In general it can be said that the higher and sharper the melting point of a crude wax, the better as far as commercial possibilities go.

"The saponification value is a direct evaluation of the total amount of esters plus free acids in a wax. It approaches a constant number for a particular kind of refined wax but if the wax contains much resinous material the significance of the saponification value becomes obscure as the presence of large amounts of resins will usually increase the saponification value.

"The acid value expresses the free fatty (or waxy) acid and is more of a variable than the saponification number.

"Chemical constants such as the saponification value and acid value are determined usually to identify and classify waxes and are not normally as important as the physical characteristics (melting point, colour etc.) with regard to commercial applications."

Forty samples from three drillholes (I, M and F) were analysed for montan wax (see Appendix 1). All samples were dried at 110°C before analysis.

Each sample was extracted using benzene as a solvent; in addition hexane, benzene/alcohol azeotrope and xylol were used as solvents on every fifth sample. Benzene was chosen as the standard with which to extract all samples because (a) it extracts all the wax but not all the unwanted resin and asphaltic material and (b) comparable figures are available for benzene extracts from lignites in other parts of the world.

The benzene-extraction figures range between 0.72 per cent. and 8.47 per cent. with an average value of 2.3 per cent. Table 25 compares the amount of montan wax in the Fitzgerald River lignite with that extracted from other lignites. The most important conclusion to be drawn from such a comparison is the low yield of wax from the Fitzgerald River lignite.

TABLE 25. AMOUNT OF EXTRACTABLE WAXES IN VARIOUS LIGNITES

Sample	Percentage Wax Extracted		Comments
	Benzene	Benzene/Alcohol Azeotrope	
Fitzgerald River lignite			
Drillhole I (A) Core 2	2.2	4.9	dried at 110°C
I (B) 2	2.2	2.7	" "
I (B) 4	2.4	5.3	" "
F 2	2.8	5.1	" "
M 1	3.5	7.4	" "
M 2	2.8	5.1	" "
M (A) 1	3.8	7.4	" "
M (A) 10	2.1	3.3	" "
Ione Formation, California (a)			
American Lignite Products mine	14.2	air dried
Buena Vista mine	6.0	dried at 105°C
Edwin No. 2 mine	7.1	10.6	air dried
	6.0	dried at 105°C
	6.6	9.5	air dried
Victoria (b)			
Morwell	2.3	air dried
Germany (b)			
Oberroblingen	13-16	air dried
Nachterstedt	17-18	air dried
Range of values	1.5-18	air dried

(a) Selvig and others, 1950

(b) Veel'ak, 1959

In order to determine certain properties of the extracted montan wax the samples were combined, as very little wax obtained from each individual sample. The samples were grouped into four bulk samples representing the upper and lower parts of the lignite bed in drillholes I and M and the results obtained are included in Appendix 1. Table 26 compares properties of Fitzgerald River montan wax with montan wax from America and Germany. The most instructive comparison is between the Fitzgerald River wax and that extracted from Ione Formation (California), which is used commercially. The Fitzgerald River wax has a lower melting range and a higher resin content than the Californian wax.

TABLE 26. SELECTED PROPERTIES OF MONTAN WAX EXTRACTED FROM VARIOUS LIGNITES

Sample	Melting Range (°C)	Acid Value	Saponification Value	Resin Content (per cent)		S.G.
				(I)	(II)	
Fitzgerald River Lignite						
Drillhole I upper part of bed	66-77	28	248	76.6	75.1	1.10
lower part of bed	66-76	27	242	78.3	1.09
Drillhole M upper part of bed	66-77	29	218	53.2	54.6	1.08
lower part of bed	68-79	31	189	73.2	73.5	1.10
				(III)	(IV)	
Ione Formation, California (a)						
American Lignite Products mine	80-83	51	114	34
Buena Vista mine	78-82	46	105	45	31	1.06
Commercial montan wax (a)						
Riebeck brand crude montan wax	81-85	27	95	23	1.03
American montan wax (b)	77-81	38	105	24	1.03

(a) Selvig and others, 1950

(b) Extracted from Ione Formation lignite

Determination of resin content

I Acetone solubility at 25°C

II Ethyl acetate solubility at 0°C

III Ethyl ether solubility

IV Ethyl acetate solubility at -10°C

ESTIMATE OF TONNAGE

An estimate of the tonnage of lignite and hence the amount of montan wax in the Fitzgerald River area can be made using the data obtained from drilling, geological fieldwork and chemical analyses. In making this estimate only the area of lignite in which drillholes I and M are situated will be considered (see Fig. 53); the area of lignite east of drillhole N is so small that neglecting it in the calculations will not seriously affect the final figure. Furthermore, the whole of the lignite area outlined in Figure 53 is included in the calculation; hence the estimate given here must be considered a maximum.

The estimate tonnage is obtained as follows:

Area underlain by lignite (see Fig. 53)	280,000 m ²
Assumed average thickness of lignite (from drillholes I and M)	3 m
hence volume of lignite	840,000 m ³
Specific gravity of lignite (as received; average of 4 samples)	1.3
hence tonnage of lignite	1,092,000 t
Amount of montan wax (benzene extraction; dry basis; average of 40 samples)	2.3 per cent
Moisture content of lignite (average of 4 samples)	50 per cent
hence average amount of montan wax (wet basis)	1.2 per cent
Amount of montan wax in 1.1 million t of lignite	13,200 t

Hence about 15,000 t of montan wax is available for extraction from an inferred 1.1 million t of lignite with an average moisture content of about 50 per cent.

CONCLUSIONS

The main conclusions which can be made as a result of this investigation are as follows:

- (1) Lignite is confined to the Werillup Formation which rests directly on Precambrian rocks. The formation crops out in the bed of the Fitzgerald River but elsewhere in the valley it is concealed by up to 12.5 m of Quaternary deposits
- (2) One bed of lignite about 3 m thick is present in the area, and this only occurs near the junction of the Fitzgerald and Susetta Rivers and was penetrated in two of the 15 holes drilled (I and M)
- (3) The total inferred reserves of lignite are estimated to amount to 1.1 million t.
- (4) The ratio of the lignite to overburden is about 1:4
- (5) The amount of montan wax extracted from the lignite by benzene ranges from 0.72 per cent to 8.47 per cent, and averages 2.3 per cent (dry basis)
- (6) About 15,000 t of montan wax are available for extraction from the estimated tonnage of lignite
- (7) The wax has a lower melting point and higher resin content than German and Californian waxes.

REFERENCES.

- Blatchford, T., 1929, Fitzgerald Brown Coal deposits: West. Australia Geol. Survey Ann. Rept. 1928, p. 5-6.
- 1930, Report on the occurrence of bituminous material which Mr. Hassell collected on Cheyne Beach and forwarded for identification: West. Australia Geol. Survey Ann. Rept. 1929, p. 8-9.
- Cockbain, A. E., 1968, The stratigraphy of the Plantagenet Group, Western Australia: West Australia Geol. Survey Ann. Rept. 1967, p. 61-63.
- Dixon, S., 1884, Notes on the supposed coal-beds of the Fitzgerald River: Royal Soc. South Australia Trans., v. 7, p. 9.
- Edwards, A. B., 1945, The composition of Victorian Brown Coals: Australasian Inst. Mining Metall. Proc. no. 140, p.205-280.
- Gregory, F. T., 1861, On the geology of a part of Western Australia: Geol. Soc. London Proc. for 1861, p.475-483.
- Lord, J. H., 1952, Collie Mineral Field: West. Australia Geol. Survey Bull. 105(1).
- Maitland, A. G., 1922, Note on the petroleum prospects on the Fitzgerald River, South-West Division: West. Australia Geol. Survey Ann. Rept. 1921, p.13-19.
- McLeod, I. R. (Ed.), 1966, Australian Mineral Industry; The Mineral Deposits: Australia Bur. Mineral Resources Bull. 72.
- Nicolay, C. G., 1876, Report on the geological features of the country between Bremer Bay and Fitzgerald River, South Coast: Appendix A of Crown Lands and Survey Report for the year 1875, Parl. Paper no. 3 of 1876, p.15-16.
- 1886, Some notes on the geology of Western Australia: London, William Clowes & Sons, Ltd.
- Roe, J. S., 1852, Report of an expedition under the Surveyor-General, Mr. J. S. Roe, to the south-eastward of Perth, in Western Australia, between the months of September, 1848, and February, 1849, to the Hon. the Colonial Secretary: Royal Geographical Soc., Jour. v.22, p.1-57.
- Selvig, W. A., Ode, W. H. Parks, B. C., and O'Donnell, H. J., 1950, American lignites; geological occurrence, petrographic composition, and extractable waxes: U.S. Bur. Mines Bull. 482.
- Vcelák, V., 1959, Chemie und Technologie des Montanwachses: Prague, Tschechoslowakische Akademie der Wissenschaften, 818 pp.
- Woodward, H. P., 1890, Annual General Report for 1888-1889: Perth, Govt. Printer.

APPENDIX 1

ANALYSES OF FITZGERALD RIVER LIGNITE SAMPLES

All analyses have been made by the Government Chemical Laboratories

1. Specific gravity, proximate analysis and gross calorific value

Sample Lab. No. (1972)	Drillhole I (A) Core 2 22050	Drillhole I (B) Core 5 22051	Drillhole M Core 1 22052	Drillhole M (A) Core 9 22053
Specific gravity (a)	1.31	1.25	1.17	1.49
Proximate analysis	per cent			
Moisture (b)	50.1	52.4	56.8	38.6
Ash	16.8	15.1	6.5	42.5
Volatile matter	19.9	19.1	21.6	12.5
Fixed carbon	13.2	13.4	15.1	6.4
	100.0	100.0	100.0	100.0
Gross calorific value	MJ/kg			
as received	8.95	9.25	10.59	5.59
Dry, ash free	27.10	28.50	23.76	29.45

(a) Specific gravity determined by displacement of water

(b) Determined by loss in weight on heating at 105°C

2. Montan wax content

Drillhole	Core	Lab. No. (1972)	Benzene	Hexane	Benzene- alcohol azeotropes	Xylol
per cent : dry basis (a)						
I	1	22054	8.47			
I (A)	1	22055	2.44			
I (A)	2 top 70-52 cm	22056	2.22	0.99	4.89	4.23
I (A)	2 52-35 cm	22057	1.01			
I (A)	2 35-17 cm	22058	2.11			
I (A)	2 17-0 cm	22059	1.06			
I (A)	3	22060	0.73			
I (A)	4 top 82-63 cm	22061	0.91			
I (A)	4 63-42 cm	22062	1.14			
I (B)	1	22063	0.94			
I (B)	2	22064	2.22	0.54	2.72	1.65
I (B)	3 top	22065	0.43			
I (B)	3 bottom	22066	0.72			
I (B)	4 top	22067	2.37	1.26	5.34	2.96
I (B)	4 bottom	22068	2.19			
I (B)	5 top	22069	1.75			
I (B)	5 middle	22070	1.96			
I (B)	5 bottom	22071	1.73			
I (B)	6 top	22072	1.72			
I (B)	6 bottom	22073	1.12			
F	2	22074	2.70	1.57	5.10	3.93
F	3	22075	4.58			
F	4	22076	5.77			
F (A)	auger sample	22077	0.99			
M	1 top 70-62 cm	22078	1.94			
M	1 62-43 cm	22079	3.50	1.32	7.43	5.34
M	1 43-26 cm	22080	2.59			
M	1 26-12 cm	22081	2.33			
M	1 12-0 cm	22082	1.86			
M	2	22083	2.83	1.47	5.08	4.14
M (A)	1 top 68-48 cm	22084	4.14			
M (A)	1 48-30 cm	22085	6.55			
M (A)	1 30-13 cm	22086	2.00			
M (A)	1 13-0 cm	22087	3.79	1.40	7.35	4.63
M (A)	2	22088	1.47			
M (A)	9 top 45-40 cm	22089	0.98			
M (A)	9 40-15 cm	22090	2.29			
M (A)	9 15-0 cm	22091	2.13			
M (A)	10	22092	2.14	0.94	3.28	2.86
M (A)	11	22093	1.25			

(a) Samples dried at 110°C

3. Properties of montan wax.

Four bulk samples of montan wax were obtained by combining the benzene-soluble fractions in the following manner:

Bulk sample 1 Lab. Nos. 22054-22060 plus 22063-22066 (Drillhole I, upper part of lignite bed).

Bulk sample 2 Lab. Nos. 22061 and 22062 plus 22067-22073 (Drillhole I, lower part of lignite bed).

Bulk sample 3 Lab. Nos. 22078-22088 (Drillhole M, upper part of lignite bed).

Bulk sample 4 Lab. Nos. 22089-22093 (Drillhole M, lower part of lignite bed).

Bulk Sample	Drillhole I upper part 1	Drillhole I lower part 2	Drillhole M upper part 3	Drillhole M lower part 4
Melting range (°C) (a)....	66-77	66-76	66-77	68-79
Acid value	28	27	29	31
Saponification value ...	248	242	218	189
Resin content (per cent)				
(b)	76.6	78.3	53.2	73.2
(c)	75.1	54.6	73.5
Specific gravity (at 25°C)	1.10	1.09	1.08	1.10

(a) Determined by closed capillary method

(b) Acetone solubility at 25°C

(c) Ethyl acetate solubility at 0°C

APPENDIX 2

PALYNOLOGY OF SAMPLES FROM THE WERILLUP FORMATION, FITZGERALD RIVER AREA

by J. Backhouse

The following core samples from drillholes in the Fitzgerald River area were examined for palynomorphs:

Drillhole	Core	Depth in metres	Lithology	F. No.
F (A)	Auger	15.12	Lignite	
I (B)	5	5.12-5.89	Lignite	
M	2	15.90-16.62	Lignite	
F (A)	2	3.65-4.00	Black carbonaceous shale	8321
G	2	6.71-7.47	Dark grey siltstone	8322
K	1	13.73-14.49	Light grey siltstone with carbonaceous inclusions	8323

The three lignite samples were prepared using fuming nitric acid. A considerable quantity of plant tissue was recovered from them, but no spores or pollen grains were observed.

The remaining samples were processed by routine palynological methods. The shale sample from drillhole F (A) (F 8321) contained abundant plant tissue but only a few spores and pollen grains. However the other two samples from drillholes G and K contained good assemblages of spores and pollen.

F 8322, Drillhole G, 6.71-7.47 m

Spores and pollen:

Gleicheniidites sp.

Dictyophyllidites cf. *D. concavus* Harris

Nothofagidites cf. *N. emarcida* (Cookson)

Proteacidites sp.

Ericipites scabratus Harris

Dacrydium florinii Cookson and Pike

Age: Early Tertiary

Environment of deposition: Probably non-marine.

F 8323, Drillhole K, 13.73-14.49 m

Pollen:

Proteacidites annularis Cookson

P. pachypolus Cookson and Pike

Proteacidites cf. *P. sp. 1* Hekel 1972

Triorites harrisii Couper

Casuarinidites cainozoicus Cookson and Pike

Nothofagidites cf. *N. hetera* (Cookson)

N. cf. N. emarcida (Cookson)

Santalumidites cainozoicus Cookson and Pike

Malvacipollis diversus Harris

Tricolpites sp.

Ericipites scabratus Harris

Dacrydium florinii Cookson and Pike

Age: Early Tertiary (Late Paleocene to Eocene)

Environment of deposition: Probably non-marine

Comments:

The abundance of pollen grains seems to be inversely proportional to the amount of carbonaceous material in the samples. The reason for this is not clear. No well documented Tertiary floras from Western Australia are available for comparison and the age determinations are based mainly on floras described from the Eastern States.

INDEX

	Page		Page
Barite	103, 105	Petroleum—	
Bullsbrook Beds	75	Angel Field	90
Bunbury Basalt	76	Angel No. 1	84
Bundera Calcarenite	59	Barrow Island	86
Calcrete	61, 64, 65	development and production	86
Chemical analyses of pillow lavas	101	Dongara Field	88
Coolyena Group	75	drilling	78
Dandaragan Sandstone	74	Eaglehawk No. 1	84
Donnybrook Sandstone	75	exploration	77
Exmouth Sandstone	59	geochemical surveys	85
False gossan	115	geological surveys	85
Gage Sandstone Member	74	geophysical surveys	84
Geochemistry of gossans	117	Gingin Field	89
Geology—		Goodwyn Field	90
Fitzgerald River lignite	127	Mondarra Field	88
Hamersley Group	122	North Rankin Field	89
Murphy Well area	107	Northwest shelf	89
North Pole	104	tenements	77
Perth Basin	72	Walyering Field	88
Paroo Station	64	Phosphate stain printing	123
Gingin Chalk	75	Phosphorus in iron formation—	
Gossans	115	apatite	122
Lancelin Beds	76	in matrix minerals	123
Laterite	115	rare earth phosphate	123
Leederville Formation	74	Pillow lavas	98
Lignite	127	Plantagenet Group	132
Mandu Calcarenite	59	Poison Hill Greensand	76
Maxicar Beds	75	Quinns Shale Member	74
Molecap Greensand	75	Soansville	98
Montan Wax	134	South Perth Shale	74
Mount Barren Beds	132	Trealla Limestone	59
Mowbowra Conglomerate	59	Tulki Limestone	59
North Pole	103	Ultramafic lava	106
Osborne Formation	75	Underground Water—	
Otorowiri Siltstone Member	74	Exmouth	57
Pallinup Siltstone	133	Wiluna	61
Palynology of Werillup Formation	138	Uranium in calcrete	66
		Warnbro Group	74
		Werillup Formation	132
		Yaragadee Formation	73
		Yardie Group	59

DIVISION V

Report of the Superintendent Surveys and Mapping for the Year 1972

The Under Secretary for Mines:

For the information of the Hon. Minister, I submit my report on the activities of the Surveys and Mapping Branch, for the year ended 31st December, 1972.

STAFF

The membership of the staff now totals 112 officers, comprising 93 males and 19 females in the following Divisions:—

Professional	37
Clerical	8
General	36
Technical	5
Cadet Cartographers	26

Cartographer Mr. E. Beasley is still seconded to the Commonwealth Department of External Territories, and is attached to the Department of Public Service of Papua New Guinea.

Cadet Cartographers Messrs. Loughton, Lofts and Kearns, qualified in the Diploma of Cartography and were appointed to the Level 1, Career range as Cartographic Draftsmen.

Two cadets, Messrs. Cresswell and Taylor qualified, in the latter part of the year, and are eligible for appointment in the new year.

On 19th June, six Level 1 Survey Examiners on loan from the Survey Examination Branch of the Lands Department commenced work in the department, to assist in the examination of the large number of accumulated surveys. This taxed the accommodation, but should greatly assist in helping to clear the backlog.

The number of Surveyors, authorised by the Hon. Minister to perform cadastral surveys for this Department, now stands at 84.

The accumulated balance of deposited survey fees, which stood at \$9,095,702 at the beginning of the year, was reduced to \$5,419,862 as at 31st December. This was mainly due to two factors, first of which was a record survey expenditure of \$625,517 and a record payout in defunded survey fees to prospectors and the departmental payment to surveyors, amounting to \$5,270,472 for the year.

This was offset by \$1,594,632 of deposited survey fees, which, after reaching the lowest quarterly intake for the past 4 years, of \$356,778 ending June, rose to \$407,103 and \$460,884 for the succeeding quarters of the year. This, coupled with

increasing demand by the companies under the Special Agreements Acts, for photogrammetric surveys, indicates a busy future for the Branch.

Metrication for surveys carried out by the Lands and Mines Departments was officially proclaimed to commence from the first day of September.

During the year a Hewlett-Packard 9810A, computer, was acquired to assist in speeding up the computations and it is anticipated that a plotting attachment will be requisitioned in the new year.

To gain space and to ensure increased security, about 35,000 of our departmental survey diagrams were microfilmed and mounted on aperture cards. This procedure will also be carried out in relation to the field books, at a later date.

All dealings under the Petroleum legislation in both the "onshore" and "offshore" areas and under the Petroleum Pipelines Act, are being handled expeditiously and all maps show the up-to-date situation at any given time.

The drawing of maps for the Geological Survey Branch and the cadastral maps for the Mining Registrars, is progressing favourably, with a heavy increase in the former, expected in the new year, when the full impact of the geological survey staff fulfilment, is felt.

Itemised reports, of the activities of the three main sections of the Branch, are appended hereto.

A. A. HALL,
Superintendent, Surveys and Mapping.

SURVEY SECTION

1. Surveys

Survey of mining leases, claims, special act mining leases, sections of temporary reserve boundaries and other tenements were carried out during the year by Licensed Surveyors by contract arrangements with the Department, Survey work done is summarised by the following tables.

Table A

Number of Surveyors	40
Number of survey field parties used	53
Number of tenements surveyed	3,730
Number of field books lodged	455
Total boundary line run	10,056.941 km
Total traverse or connection line run	588.013 km
Total area delineated by survey	397,916 ha
Total distance travelled	103,298 km
Total value of survey work	\$551,840.72
Total value of photogrammetric survey	\$ 73,676.34
Total	\$625,517.06

Table B

Surveyor	Field books	Surveys	Hectares
M. M. Fisher	49	484	49,353
F. R. Rodda	28	298	30,837
J. A. Jamieson	30	240	24,888
D. F. V. Wilson	24	229	25,327
L. J. Burkett	30	199	20,167
K. J. Amsuss	31	*196	*122,442
A. G. Thompson	19	180	19,783
R. J. Benetti	19	180	19,825
D. J. Cox	16	149	16,226
W. A. Berryman	18	147	27,917
M. J. McKimmie	16	188	14,956
J. P. Zadnik	13	118	11,958
T. L. Markey	20	*116	†11,781
K. F. Patterson	14	115	12,730
P. J. Hille	11	95	9,854
G. G. Bateman	10	95	9,086
D. H. Stewart	9	91	10,992
L. G. Privett	9	86	7,581
W. N. Thompson	12	85	7,671
A. K. King	8	71	7,798
G. C. Callaghan	7	57	4,821
A. C. Watson	5	53	5,007
E. H. W. Babb	5	50	4,902
P. Hunt	5	38	4,330
P. J. Hanneberry	5	35	4,002
L. M. Gordon	5	27	3,223
M. C. Brown	5	24	2,689
P. R. Blackadder	2	24	1,066
C. D. McAllister	4	19	2,278
R. A. Holland	2	15	1,806
B. A. McNamara	3	15	1,166
M. J. Byrne	7	13	2,217
D. C. Forster	2	12	1,168
H. W. Denton	1	10	604
K. J. Croghan	3	88	†
W. S. Richards	1	8	971
J. Guidice	2	6	380
R. A. Hoskin	1	4	24
Australian Aerial Mapping	†
Associated Surveys	†
	455	\$3,730	397,916

* Includes some surveys measured photogrammetrically.

† Excludes some area in a photogrammetric survey.

‡ Photogrammetric surveys only.

§ Excludes 167 tenements ground marked for a photogrammetric survey but not yet lodged. (Hamersley.)

Forty surveyors are shown as submitting work to the Department, whilst this figure can be increased to 53 effective survey field parties due to amalgamations in some organisations and others submitting field work through one nominated chief

surveyor.

Eleven new surveyors were introduced to the work for the first time during this year, whilst 7 surveyors, who did work during 1971 did not function during 1972.

This record amount of field activity has been co-ordinated by this Section and survey parties have been deployed in the manner and in places to give the most suitable and efficient conduct and integration of field activities. It is interesting to note that the total distance of actual survey line ranged, measured and marked (10,057 kilometres) greatly exceeds the direct-line distance from Perth to Sydney and back again. (8130 kilometres).

During May of this year, a new procedure was introduced whereby a letter of intended survey was sent to each applicant prior to listing the claim for survey. The letter asked for the applicant's intentions regarding continuation of the claim with the intention of assessing the need for the survey. During the year, 10,438 claim holders were contacted in this manner and 3787 replied saying that they were holding their ground, whilst a further 599 stated that more time was needed to assess the situation and requested that the survey be pending. A further 4211 indicated that they were relinquishing their ground, whilst a further 1841 had not yet replied to the letter. If these figures are applied to the number of tenements not yet surveyed they project that approximately 20,000 tenements remain for survey at this stage, not taking into account any further pegging.

In order to relieve the work-load on the Drafting personnel, clerical assistance has been provided to operate in the area of payment of accounts, survey statistics, and general office recording. This has proved of great assistance in overcoming problems in these areas.

2. Special projects

Three further photogrammetric surveys were commenced during the year. One was at Yeelirrie where the Western Mining Corporation has found significant uranium and has pegged the ground with 330 claims. One was at Barrambie which covered a belt of claims held by the Ferro-vanadium interests and the third was of the remaining Sections of ML 4 SA for Hamersley Iron Pty. Ltd. in the Hamersley Ranges.

The survey of ML 249 SA for Goldsworthy Mining was commenced. Work was started on those sections in the Abydos area and some extremely rugged terrain was encountered. Permission was sought and obtained to use electronic distance measuring instruments on those boundaries which could not be measured by conventional means.

Some of the problems encountered on this survey are unique to mining surveys as the following extracts from the report indicate:—

Considerable difficulty was experienced on this job due to a general lack of access. Nearly all travelling was cross-country and this took a heavy toll of our four wheel drive vehicles, particularly tyres and a higher than normal consumption of fuel. The general terrain is rocky, with numerous dry river beds and gullies to be crossed in day to day activities. In several of the leases surveyed by cadastral methods we could not get our vehicles into the job and this necessitated quite long and arduous treks into the hills. This was particularly the case in the survey of Lease Sections 18, 19 and 20.

Most of this work was carried out using either a 4 or a 5 man field party made up of two surveyors and the balance field assistants using two vehicles and two theodolites to overcome terrain difficulties and the possibility of one of the vehicles breaking down which would have resulted in the personnel becoming stranded some miles from the base camp ... and again

From the South West corner of Section 12, to the second intermediate along the Southern boundary is a distance of approximately 400 metres. A gorge of 100 metres depth separates these points and to travel from one to the other carrying the equipment required, took one hour and ten minutes. The complete Southern and 50% of the West and East boundaries of this section, were completed on foot. The complete Northern boundaries of Sections 11, 16 and 19 were also completed on foot. On lines of this "walk-on" nature it can be imagined the quantity of materials and equipment required to be carried. Each man carried his own water and food for each day.

All corners of each lease section have been marked in the normal manner and targeted for aerial identification, by means of 6 metre rock pointers painted white. In some instances, this necessitated carting rocks from up to three kilometres distance. This and the time involved in painting, meant that 2-3 hours were spent in marking and identifying some corners. Photographs have been included showing examples of the standard of marking.

The identification of some corners was difficult and in one or two cases impossible, due to actual lack of physical detail and recent bush fires.

By any means, the successful completion of this job would be classed as extremely difficult. However, in spite of this, we feel that electronic distance measuring equipment did in fact prove most successful in overcoming difficulties and problems of measurement. The unit used had a nett weight of 24.6 Kg (54 lb) and obviously presented difficulty in carrying. This would be the only disadvantage which we will overcome with delivery of a new unit within a few weeks, that weighs in at 10 Kg (22 lb).

With the added flexibility and mobility available with this equipment we feel more attention can be given to obtaining rapid and accurate results in difficult boundary definition and particularly control traverses . . .

3. Metric units

During this year, the Regulations for the Guidance of Surveyors were amended to make the use of metric units a statutory requirement. These came into operation on 1st September. I report that at this stage the field transition to metric units has progressed with no major problems and most Surveyors are now familiar with using the metric units.

To differentiate between imperial units and metric units on plans and diagrams, a new design and format for the survey plans and diagrams was introduced to coincide with the introduction of metric units. Office staff are now familiar with data in metric units and no problems are apparent. Because not all Branches in the Department use metric units at this stage, some problems may occur when data is notified to them in metric units.

4. Amendment to fees and regulations

Following an approach by the Institution of Surveyors to the Minister for Lands requesting a revision to the scale of fees for contract surveys, a committee including a representative from this Department was set up to review and report on a new scale. It is anticipated that the schedule will be brought into line with present day practices and eliminate anomalies that have evolved over the years.

This Department is also represented on a committee which is currently reviewing the Survey Regulations with a view to updating them to facilitate modern practices.

5. Geodetic

Due to concentration of staff on other survey activities, only work of an urgent nature was done in this area.

6. Petroleum

The collation and compilation of the presently known bathymetry of the continental shelf from the North-West Cape to the Northern Territory border was completed at a scale of 1:1000000. This data was available from the published results of the various seismic surveys which have been done in this important area. The results give an appreciation of the actual bathymetry but more accurate surveys, particularly future improvements in navigational aids, will be necessary before the results can be called reliable.

All dealings in both "onshore" and "offshore" areas and under the Petroleum Pipe-lines Act are being handled expeditiously and all maps show the up-to-date situation at any given time.

7. Conclusion

Once again a year of record field work completed has been accomplished and it now remains for these results to be properly integrated onto the plans and other records in a manner which will be of lasting benefit to the Department and the mining community.

MAPPING SECTION

Standard Mapping

A total of 157 new 1 : 50,000 scale plans were produced in this section during the year requiring an original, a working transparency for making prints for sale and 2 mounted prints edged and coloured to be used at Head Office and respective outstations.

The programme of revision was continued and 40 plans were updated and adjusted where necessary.

The areas covered either in whole or part with 1 : 50,000 sheets were the following 1 : 250,000 map areas:—

Widgiemooltha
Glengarry
Mt. Phillips
Robinson Range
Boorabbin
Yarraloola
Southern Cross
Roebourne

The Yarraloola area was remapped by the Lands Department using photogrammetric computations on A.M.G. thus providing a very good working base.

The programme of 1 : 100,000 scale maps was continued and sheets were produced of Kingston and Dixon Range areas from National Mapping base sheets on A.M.G.

Geological Mapping

1 : 250,000 Maps

The programme mapping continued and the following sheets were completed and sent for printing:—

Cue
Norseman
Esperance-Mondrain Island

Preliminary editions were published of:—

Edjudina
Esperance-Mondrain Island
Lake Johnston
Ravensthorpe

Other sheets completed during the year were:—

Murgoo
Malcolm-Cape Arid
Perth
Pinjarra } part sheets only.
Moora
Perenjori }

Sheets in progress were:—

Seemore } Preliminary editions
Mason }
Vernon }
Yalgoo }
Collie } part sheets only
Pemberton }
Dongara-Hill River } Final Editions
Ravensthorpe }
Geraldton—private contract }

State Map

Screen masters for printing plates were made but printing was deferred.

Seventy-one diagrams covering the Phanerozoic areas were prepared for the Geology of W.A. bulletin.

Over 300 miscellaneous plans were drawn for various hydrological reports, bulletins and other publications.

Information pamphlets were prepared and printed for:—

Nickel in W.A.
Uranium
Aluminium

Photography

The photographic section continued to be under heavy pressure during the year with much variety of work. The assistant to the photographer resigned in April and because of delays due to the reclassification of the item, a replacement was not made until November.

1,834 items were prepared on the process camera including reductions, enlargements and same size copy.

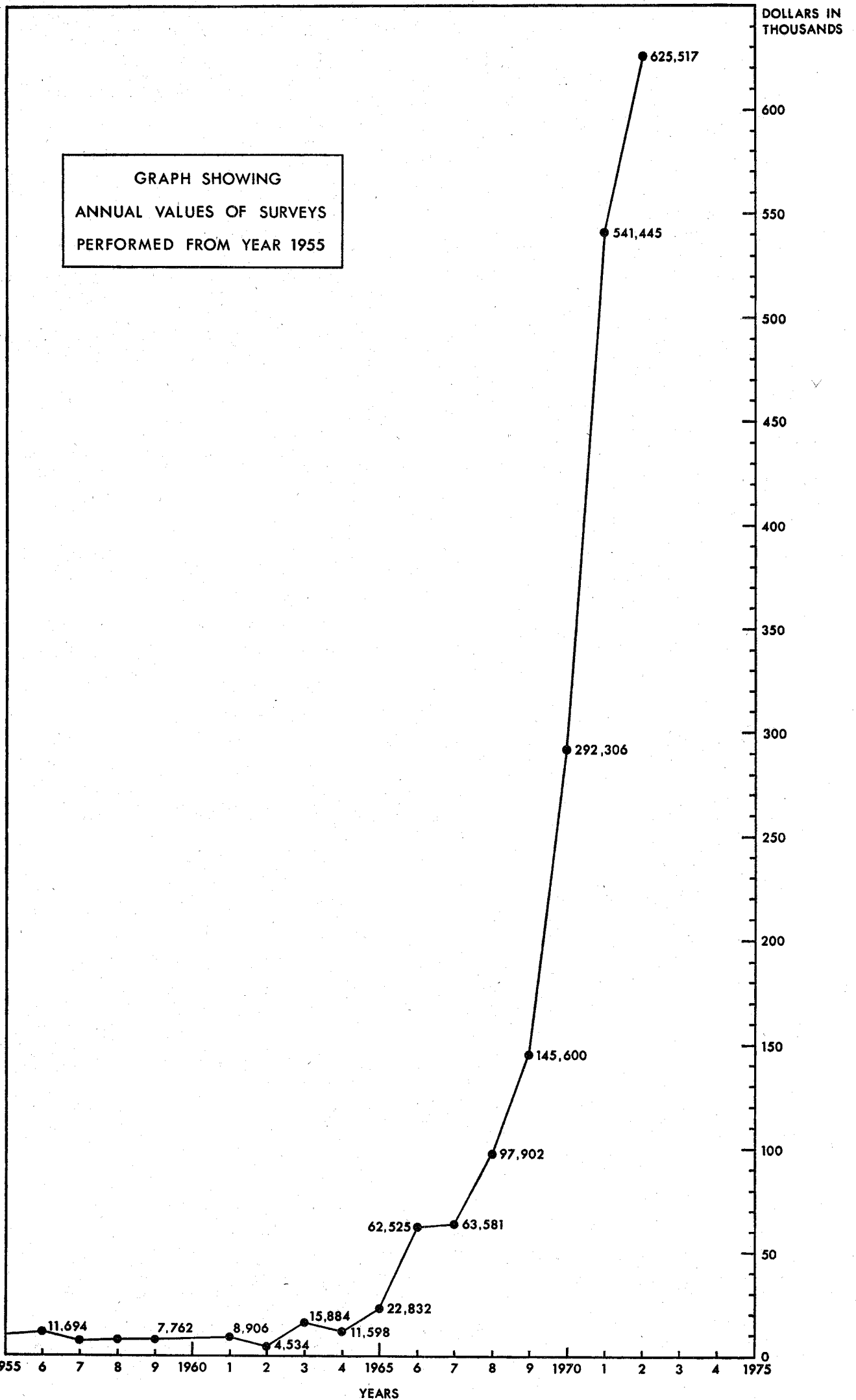

1,840 items were processed on the vacuum frames including metal plates.

1,892 items were processed involving the Enlarger.

52 rolls of 35 mm film, both colour and black and white were processed and a variety of prints made and many projection slides both colour and black and white were prepared.

15 enlarged colour prints (40 in. x 30 in.) of maps were made.

Plan Printing

Printing of various types of plans remained steady with 40,757 prints being done, 3,000 plans being mounted and 3,300 plans being photocopied making a total of 47,057 items processed in the section.

PUBLIC PLAN SECTION

During 1972 there were 15,700 applications for mining titles received for processing. Of these, 13,732 were for Mineral Claims, whilst a renewed interest in gold accounted for 531 Gold Mining Lease applications being lodged compared with 163 such applications in the previous year. 1,968 applications for other forms of tenure were also lodged.

The final appraisal resulted in carry over of 7,076 check sheets at the end of the year, although those requiring Titles Office searches were brought up to date.

The Public Plan System housed at the main counter was again greatly improved and base coverage with the R502 series at a scale of 1 : 250,000 was completed. Plan sales at the counter exceeded \$11,000.

DIVISION VI

CONTENTS

Administration—	Page
Committees	149
Staff	149
General, Samples and Operations in 1972	150
Summarized Reports of Divisions—	
Agriculture	154
Engineering Chemistry	161
Foods, Drugs, Toxicology and Industrial Hygiene	164
Industrial Chemistry	169
Kalgoorlie Metallurgical Laboratory	173
Mineral	174
Water	181
Tables showing Source and Nature of Samples received in 1972—	
General, Table 1	153
Agriculture Division, Table 2	155
Food, Drugs, Toxicology and Industrial Hygiene Division, Table 12	165
Kalgoorlie Metallurgical Laboratory, Table 19	173
Mineral Division, Table 20	174
Water Division, Table 21	181

DIVISION VI

Government Chemical Laboratories Annual Report—1972

Under Secretary for Mines:

I have the honour to present to the Hon. Minister for Mines a summarised Annual Report on the operations of the Government Chemical Laboratories for the year ended 31 December, 1972.

Administration

At 31 December, 1972, the Government Chemical Laboratories consisted of 7 Divisions, a Library and a central office all under the control of the Director (Government Mineralogist, Analyst and Chemist) as follows:

Director—L. W. Samuel, B.Sc., Ph.D.,
M.A.I.A.S., M.R.S.H., M.Inst.F.,
F.R.A.C.I., F.R.I.C.

Deputy Director—R. C. Gorman, B.Sc.,
M.A.I.A.S., A.R.A.C.I.

Agriculture Division—H. C. Hughes, B.Sc.,
A.R.A.C.I., Chief of Division.

Engineering Chemistry Division—B. A. Goodheart, B.Sc., A.M.I.E. Aust., A.R.A.C.I.,
Chief of Division.

Foods, Drugs, Toxicology and Industrial Hygiene Division—N. R. Houghton, B.Sc.,
A.R.A.C.I., Chief of Division.

Industrial Chemistry Division—E. B. J. Smith,
B.Sc., D.Phil., M.A.I.A.S., A.R.I.C.,
A.R.A.C.I., A.P.I.A., Chief of Division.

Kalgoorlie Metallurgical Laboratory—G. H. Muskett, A.W.A.S.M., M.Aust.I.M.M., Officer
in Charge.

Mineral Division—G. H. Payne, M.Sc.,
A.W.A.S.M., A.R.A.C.I., Chief of Division.

Water Division—N. Platell, B.Sc., A.R.A.C.I.,
Chief of Division.

Librarian—N. L. Lombardi, A.L.A.A.

Office—D. E. Henderson, Senior Clerk.

In my report for 1971 I referred to the then recent transfer to us of the Kalgoorlie Metallurgical Laboratory and the need to re-vitalise this group. This has been very successful during 1972 and 5 appointments have been made, as shown in the report of that Laboratory. This has enabled a considerable amount of work to be done. In comparing the activities of the Government Chemical Laboratories for 1972 with previous years the work of the Kalgoorlie Metallurgical Laboratory has been excluded to avoid upsetting a true comparison.

The close association of these Laboratories with other Government Departments and kindred associations was maintained during 1972 and various members of the staff are members of the following Committees:

Commonwealth Scientific and Industrial Research Organisation State Committee.

Fluoridation of Public Water Supplies Advisory Committee.

Food and Drugs Advisory Committee.

Laboratory Safety Committee.

Oils Committee of the Government Tender Board.

Paints Advisory Committee of the Government Tender Board.

Pesticides Registration Committee.

Pesticides Residues Advisory Committee.

Poisons Advisory Committee.

Rivers and Waters Technical Advisory Committee.

Scientific Advisory Committee under the Clean Air Act.

Swan River Conservation Board.

Veterinary Medicines Advisory Committee.

Water Purity Advisory Committee.

In addition the Director is a member of a Committee dealing with the disposal of the effluent from the Laporte Titanium works and the Deputy Director is a member of the Western Australian Institute of Technology Advisory Committee on Applied Chemistry.

Most of these Committees are very active and meet regularly and occupy considerable time of the officers concerned, not only for meetings, but also for inspections, preparation of information and analyses of samples.

The Pesticides Registration Committee dealt with 154 applications for registration of new pesticide formulations. The total number of applications considered by this Committee to 31st December, 1972, is 2,810. A matter of great concern to this Committee is the poisonous nature of many of the newer pesticides, especially as many of them can be absorbed through the skin. The Committee has maintained its past policy of on occasions refusing registration of a pesticide as being too hazardous to health; placing an upper limit on the concentration of the active ingredient in the formulation to be distributed; or has restricted distribution to commercial pest exterminators. For the Swan River Conservation Board we analysed 143 samples of river water and 11 samples of effluents. The Veterinary Medicines Advisory Committee dealt with 1,037 applications, being 841 renewals, 165 new registrations, 18 deferred, 4 not required to be registered and 9 rejected.

At 31st December, 1972, the establishment of the Laboratories was 129 being:

Professional	74
General	42
Clerical	10
Wages	3

1972 was a very difficult year for staff, not as in the past which, before 1968, was the difficulty of obtaining suitable staff and from 1968 to 1971 was the large number of staff changes but simply because financial restrictions prevented us from obtaining any more staff. Since we received in 1972 some 15 per cent more samples than in 1971 we just could not handle the volume of work. We therefore lost ground again in our service to other Government Departments and to the public. At the 31 December 1972 we had 5588 samples in hand compared with 3833 at 31 December 1971. Nevertheless in 1972 we did deal with 2459 samples

more than in 1971 and this despite the dislocation caused by fire and consequent re-building, referred to elsewhere in this Report.

Library

Additions to the Library in 1972 totalled 3124 items. This total included 200 monographs, 2249 periodicals (separate items), and 327 reports (separate items). During the year 12 new periodical titles were added to the Library making a total of 287 periodicals now being received. Loans to outside borrowers were 350. We requested 296 items from other libraries. Items catalogued and indexed were 3056.

Buildings—Fire

On the evening of Saturday 8 January 1972 fire broke out in the Laboratories at approximately 8 pm and considerable damage was done to buildings and equipment before it was brought under control about 3 hours later.

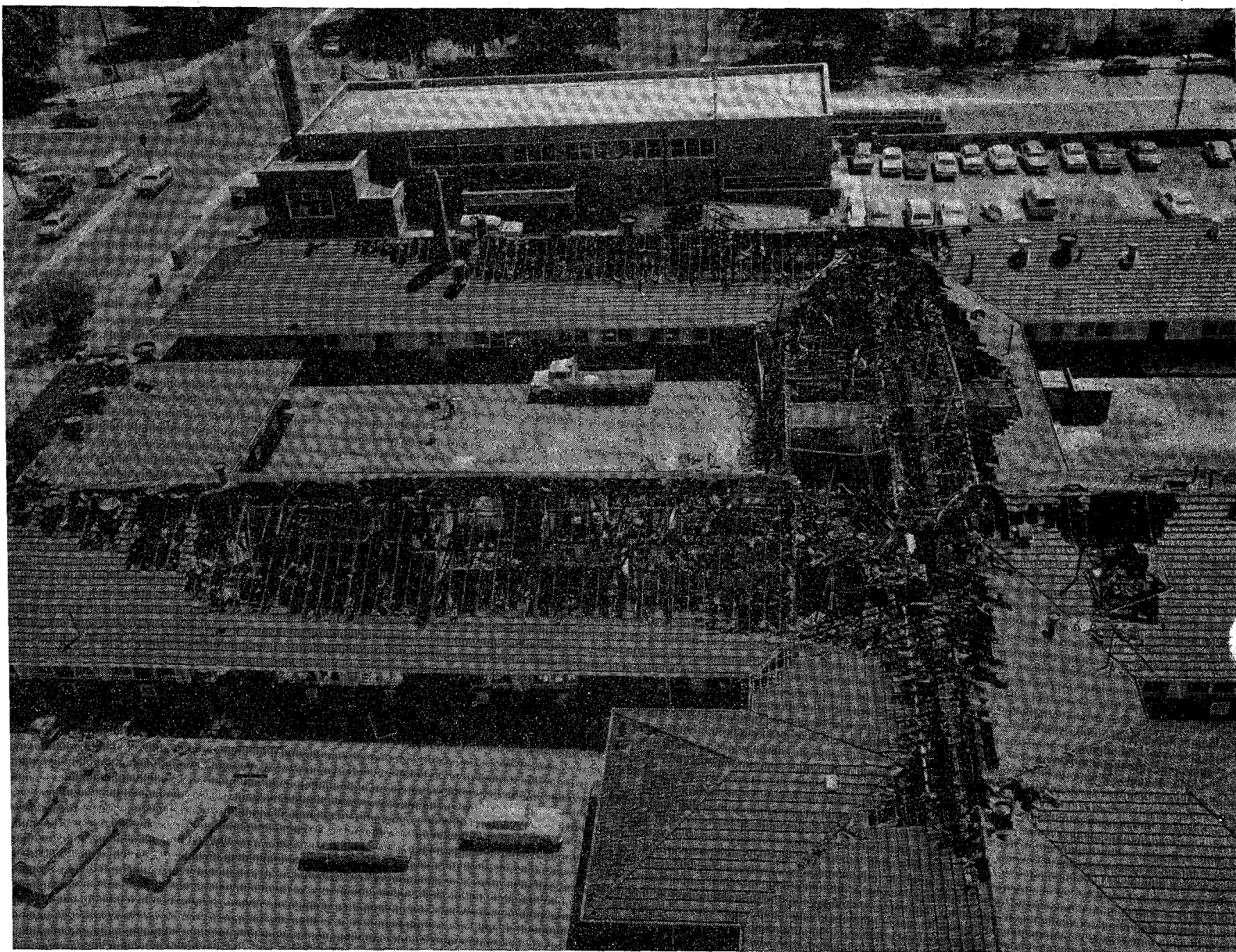

Fire Damage—General View



Laboratory

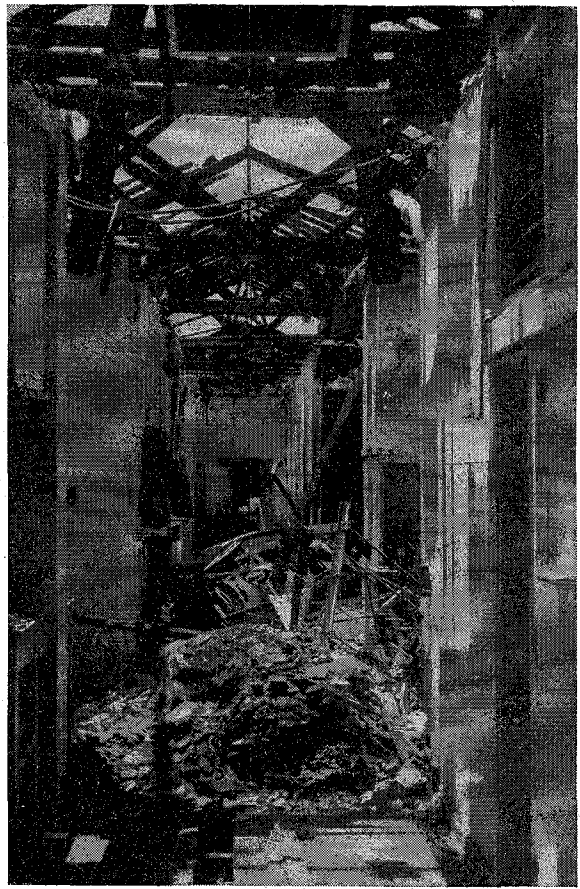

East-West Passage

Food and Drug Division



Laboratories
Main North-South Passage

Approximately one quarter of the Laboratories was completely gutted and a further quarter was damaged by fire and water. The Food and Drug Division was the most severely affected, the Mineral Division the next most extensively damaged, with lesser damage to the Agriculture Division and the Water Division. The losses were estimated at \$400,000 for re-building and \$100,000 to replace equipment but the final costs are not yet available. By crowding our staff closer in the unaffected buildings and by the loan of equipment from several outside sources we managed to continue operations during the year although under the severe difficulties of the re-building programme. Despite this dislocation we dealt with 2459 more samples in 1972 than in 1971 as previously mentioned.

The Public Works Department moved very rapidly to effect cleaning up operations and the re-building of the damaged structures and our thanks are due to that Department for such effective action. At 31 December 1972 re-building was practically complete, all that remained to be done was the installation of our main air-conditioning unit and of fire warning service.

Various relevant Authorities have investigated the fire but as yet no cause has been assigned to it.

Traffic Act—Drinking Drivers

During 1972 defence counsels adopted the attitude of requiring the prosecution to prove every detail of adherence to the Regulations and as a consequence the Director was required to appear in Court on some 70 occasions over the period January to December. The Courts concerned were mainly in Perth and Fremantle but ranged as far afield as Port Hedland and Collie. However when defence counsels were convinced that if proof of compliance were required then the Director would attend Court to give it, the practice was reduced very markedly after August.

For the past few years we have attempted a dissection of some of the information available to these Laboratories concerning "drinking drivers". Unfortunately we have not complete information but it is considered of value to publish now what we do have. For appreciation of the values obtained for the concentration of alcohol in the blood of drivers the legal levels in Western Australia are—

- (1) it is an offence to drive a motor vehicle with a concentration of 0.08 per cent (0.08 g per 100 ml) or more of alcohol in the blood.
- (2) a concentration of 0.15 per cent or more of alcohol in the blood is conclusive proof that the person is under the influence of alcohol "to such an extent as to be incapable of having proper control of a vehicle, horse, other animal or drove of animals."

The authority to require a driver to submit to sampling of his blood for the determination of alcohol was introduced late in December 1966. The following Table shows for each year since then the number of samples of blood analysed and the average concentration of alcohol found.

Alcohol in blood of drivers		
Year	No. of samples analysed	Average concentration of alcohol
1967	267	0.203
1968	305	0.206
1969	721	0.188
1970	598	0.197
1971	781	0.189
1972	656	0.190

Western Australia is the only State in the Commonwealth which provides for calculating the change in concentration of alcohols in the blood during the time between the occurrence of the event giving rise to the sampling and the actual sampling. The provision is a benefit to the accused much more often than not.

Alcohol in blood of drivers.

Effect of time interval between the occurrence of the event and the sampling of the blood.

Year	The calculated value is lower higher than the analysed value	
	No. of samples	
1967	132	69
1968	139	80
1969	421	164
1970	317	152
1971	443	187
1972	376	181

The totals of the above samples are less than the totals previously given because sometimes the—

calculated value is equal to the analysed value; data permits only the calculation of the maximum and minimum values at the time of occurrence of the event;

analysed value is nil;

data available is not sufficient for a calculation.

We receive samples of blood and/or urine from some, but not all, of the persons killed in traffic crashes. Some information can be derived from these samples but I emphasise that the following applies only to traffic deaths for which we have received samples of blood and/or urine i.e. samples forwarded to us by the Police Department.

In 1969 there were 114 drivers involved in fatal traffic crashes who were not themselves killed and of these, 18 were tested for alcohol (16 per cent.). Of these 18—

- two had no alcohol in their blood;
- another 5 had less than 0.080 per cent;
- 3 had 0.080 per cent or more but less than 0.150 per cent;
- 6 had 0.150 per cent, or more;
- for the other two drivers it was only possible to calculate a maximum and minimum percentage of alcohol in the blood at the time of the event, and these were greater than and less than 0.150 per cent.

In 1970 the figures were 31 drivers tested out of 160 drivers surviving a fatal traffic crash (19 per cent.). Of these 31 drivers—

- 3 had less than 0.080 per cent. of alcohol in their blood;
- 6 had 0.080 per cent, or more but less than 0.150 per cent;
- 3 had calculated maximum and minimum values above and below 0.080 per cent;
- 17 had 0.150 per cent, or more;
- 2 had calculated maximum and minimum values above and below 0.150 per cent;

In 1971 the figures were 33 drivers tested out of 135 surviving drivers (24 per cent.). Of these 33—

- 7 had no alcohol in their blood;
- 6 others had less than 0.080 per cent;
- 1 had calculated maximum and minimum above and below 0.080 per cent;
- 12 had 0.080 per cent, or more but less than 0.150 per cent;
- 5 had more than 0.150 per cent;
- 2 had calculated maxima and minima above and below 0.150 per cent;

In 1972 the figure were also 33 drivers tested out of 135 surviving drivers (24 per cent.). Of these 33 drivers tested—

- 1 refused the test;
- 2 had no alcohol in their blood;
- 8 had alcohol in their blood, but less than 0.080 per cent;
- 1 had calculated maximum and minimum above and below 0.080 per cent;
- 10 had 0.080 per cent or more, but less than 0.150 per cent;
- 8 had 0.150 per cent or more;
- 3 had calculated maxima and minima above and below 0.150 per cent.

In 1971 the available data for fatal traffic crashes involving only one driver and no-one else were examined. For 73 such drivers, 2 not killed were not tested and for the other 71 the distribution of concentration of alcohol in the blood was—

1971		No. of Drivers
Alcohol per cent		
Nil	30
0.001-0.079	8
0.080-0.149	14
0.150 or more	19
		71

For 1972 there were 97 one driver fatal traffic crashes for which we received information and samples. Of these—

- 10 not killed were not tested;
- 1 had calculated maximum and minimum values above and below 0.150 per cent.

For the other 86 drivers the distribution of concentration of alcohol in the blood was—

1972		No. of Drivers
Alcohol per cent		
Nil	25
0.001-0.079	7
0.080-0.149	22
0.150 or more	32
		86

General

The number of registrations for 1972 was 4,791 compared with 5,204 for 1971. This is a reduction of some 8 per cent but the number of samples covered by the registrations increased by some 17 per cent, from 19,887 in 1971 to 23,176 in 1972.

The source of the samples received and their allocation to the various Divisions are shown in Table 1. In a number of cases sample(s) were

allocated to more than one Division because for the full elucidation of the problem it was necessary to call on the ability and experience of different specialists. Such samples are not usually registered twice but do show in the totals of samples received by the Divisions so the total in Table 1 is greater than the total of samples quoted earlier in this report. This co-operation between and mutual assistance of Divisions helps to foster the policy that we are one Government Chemical Laboratories not 7 separate Divisions. Discussion and interchange of ideas between Divisions is encouraged since the problems received by one Division may be helped by, indeed may rely on, the specialist in another Division.

During 1972 there was some re-arrangement of Government Departments and it is pleasing to record that even in its year of inception the Department of Consumer Protection was aware of the services available from these Laboratories. During the year we received samples from 18 of the 31 Government Departments—again showing the extremely widespread nature of our activities.

As a result of publicity for the treatment of cancer patients with an aqueous extract of the native shrub *Scaevola spinescens* these Laboratories continued the field collection of the shrub and the preparation and supply of the extract. When we previously did this, 1957-59, supply was through the Public Health Department but now we are supplying direct, having first obtained the written concurrence and approval of the patient's medical adviser.

The number of registrations and of samples does give some measure of our activities but does not completely describe our work. A major factor in this is the variation in the amount of work associated with different samples. Also it is not possible to give a statistical account of the time and effort devoted to the various Committees mentioned; to advisory work for Government Departments, industrial firms and the general public; attendance at Courts; visits to factories and so on.

TABLE 1
SOURCE AND ALLOCATION OF SAMPLES RECEIVED DURING 1972.

Source	Division						Total
	Agriculture	Engineering Chemistry	Food and Drug	Industrial Chemistry	Mineral	Water	
STATE—							
Aboriginal Affairs Authority					11	4	15
Agriculture Department	7,582	75	737	4	193	55	8,646
Community Welfare Department					1		1
Consumer Protection Bureau					3		3
Development and Decentralisation Department	2		1	5		4	12
Education Department	12						12
Environmental Protection Department						3	3
Fisheries and Fauna Department			136			28	164
Harbour and Light Department				7			7
Hospitals	3		169			6	178
Labour Department			96		1		97
Main Roads Department	4			7	43	1	55
Medical Department			1			6	7
Metropolitan Water Board		1				2,305	2,306
Milk Board			169				169
Mines Department	15	11	97	51	2,136	409	2,719
Police Department			2,169		117	2	2,288
Public Health Department	33		973	6	1,050	57	2,119
Public Works Department	22		55	58	15	1,840	1,990
State Government Insurance Office					2		2
State Housing Commission					14	4	18
State Shipping Service			1				1
Swan River Conservation Board			8			156	164
Treasury Department	1		118	112	80		310
University of Western Australia					7		8
W.A. Fire Brigade Board			1				1
W.A. Government Railways			3				3
COMMONWEALTH—							
Health Department			2				2
Navy Department					1		1
Postmaster General's Department					1	1	2
Repatriation Department			1			4	5
Royal Australian Air Force						1	1
Works Department					8		8
PUBLIC—							
Free	12		1		18	1	32
Pay	169	83	543	17	833	648	2,293
TOTAL	7,855	170	5,281	267	4,534	5,535	23,642

Fees were charged for work undertaken for some State Government Departments, Government Instrumentalities, Commonwealth Government Departments, Hospitals, Milk Board, private firms and the general public, but the greater part of our work is done without charge for other State Government Departments.

The summarised reports of the individual Divisions which follow show the very wide range of subjects dealt with by these Laboratories. Comparing 1972 with 1971 there were some marked alterations in the numbers of various types of samples received. These were—

Marked increase	1971	1972
Clay	n.s.r.	259
Complete mineral analyses ..	312	859
Criminal cases	120	173
Dusts	571	1058
Fish	258	450
Geochemical analyses	n.s.r.	826
Gold ores	121	249
Pasture	1074	2054
Peanuts	n.s.r.	419
Soils	804	1747
Swan River Survey ..	102	143
Urine, industrial	153	220
Vanadium	17	227
Marked decrease		
Glover ..	953	110
Milk	321	255
Nickel ore	111	42
Pesticides	202	87
Specimens from patients	252	146
n.s.r.—not sufficient for separate recording		

These changes reflect some interesting alterations in general activities during the year—

- an upsurge of interest in clays and gold;
- the continued increase in concern over atmospheric pollution, as shown by the number of dust samples received;
- the great concern at the level of mercury in fish;
- a swing in the Department of Agriculture away from individual pasture plants to the mixed pasture and increased activity in soils;
- the attempts to grow peanuts in the Ord River irrigation area;
- the extension of the jurisdiction of the Swan River Conservation Board;
- the continued decrease in interest in nickel ores.

There have also been some appreciable changes in the number of samples forwarded to us by individual sources—an increase in samples from Hospitals, from 108 to 178; from the Mines Department, from 1464 to 2719; from the Public Health Department, from 1413 to 2119; from the Treasury, from 155 to 310—a decrease from the Department of Fisheries and Fauna, from 519 to 164.

L. W. SAMUEL,
Director.

AGRICULTURE DIVISION

Introduction

As the result of the fire on Saturday 8 January the work of the Division was disrupted by the complete destruction of the trace-element laboratory and the spectrograph room with their associated instruments, a major sample preparation room with its mills, and extensive damage to other smaller laboratories and the office of the Chief of Division.

All sections of the Division were affected by loss of services and dirt and water damage.

Excellent work in the early stages by electrical and other contractors and officers of the Public Works, co-operation from other Government departments and Divisions of these Laboratories, and

offers of help from all sides aided the staff who, having commenced the colossal task of salvage and cleaning up on the Sunday morning, resumed some analytical work by Wednesday 11th.

Given the disadvantages inherent in crowding and improvisation, with the use of mills borrowed from the Department of Agriculture we were back, if not to business-as-usual, at least to something like normal operations by Friday 21st. Unfortunately replacement and reconstruction had not been completed by the end of the year.

Nature and Output of Work

In spite of the hindrances and thanks to staff co-operation, output in terms of numbers at 7,343 improved to the extent of 1,868 samples by comparison with 1971. But we paid the penalty of being seen to cope with apparent disaster by having 7,855 samples submitted to us which was 1,611 more than the previous year, and we have 2,805 samples in hand, some of them submitted 9 months previously, in March. The outstanding samples are to do with experimental work in Agriculture, a system of priority for samples taken under regulatory Acts and diagnostic samples being necessary.

Another and growing consideration is work connected with air pollution and environmental protection.

Samples of foliage of fruit trees and vines, native vegetation and pastures have been taken following damage suspected of being caused by air pollution from industrial sources. Confirmation of this connection, or exoneration of the suspected pollutant is called for quickly, so that samples of this nature must receive very prompt attention.

Other samples, including in addition clays and bricks, pipes and tiles, animal urine and bones, form parts of surveys of longer term effects. But since results are required for presentation to meetings of the Scientific Advisory Committee Subcommittee on Fluoride Emissions, or form part of for instance the Coogee Air Pollution Survey, these have also received prior attention over the more traditional work of the Division which prompted the expertise in agricultural chemistry for application to environmental problems.

It can only be expected that environmental work will grow as more studies of particular areas before the establishment of new industries or new amenities are carried out, and as monitoring to chart the effects of these or existing establishments also grows.

Staff

More staff for the Division is required to correct the present delays in agricultural experimental work and ensure that environmental work can be handled promptly.

Failure to meet these requirements results in the fracturing of chemical staff among other Departments with wasteful duplication of instruments in the hands of persons not able to use them to the best advantage, and not able to call on the existing capabilities of the several Divisions of these Laboratories.

Staff Changes

Mr. Jago became Acting Chief of Division during the period April-October when Mr. Hughes was on long service leave, and in turn Mr. Rowley carried out the duties of Assistant Chief.

Mr. J. Challinor, a chemist employed in this Division as a Technician, transferred to the Food and Drug Division as Chemist and Research Officer. Miss D. Knott and Mr. S. Dixon resigned during the year, and Mrs. M. Bradshaw and Mr. M. Offer commenced duty as Technicians early in December.

Professional

During a visit to England Mr. Hughes called on the Laboratories of the Government Chemist and discussed instruments, analytical methods and particularly fluorine as a component of air pollution. He continued to serve on the membership promotion and careers and guidance sub-committees

of the W.A. Branch of the Royal Australian Chemical Institute. Mr. Jago became President of the W.A. Branch of the Australian Society of Soil Science and accepted office on the committee of the Analytical Group of the R.A.C.I.

Mr. Jago also delivered a paper entitled "Fluoride" to the Symposium on Environmental Assessment organised by the Analytical Group which was attended by most of the chemists of the Division.

The program of talks within the Division continued. The speakers, with the title of their talk and their branch of the Department of Agriculture where appropriate to those speakers not drawn from our staff were:

- (1) Dixon, T. J.: Oil Seeds and Fatty Acids.
- (2) Smetana, P. (Poultry Branch): Lupins and Poultry Nutrition.
- (3) Quayle, D. J.: Mercury as a Pollutant and its Determination.
- (4) Jones, L. T. (Plant Research Division): Vegetable Growing in Sand.
- (5) Williams, G. D.: Control of Chemical Analysis.
- (6) Laing, I. A. F. (Soils Division): Catchment Treatment for Farm Dams.

- (7) Wilson, P. E.: Selective Ion Electrodes.
- (8) Fels, H. E.: (Sheep and Wool Branch): Why Analyse Feeds?
- (9) Codling, B. J.: Soil pH.

Equipment

An Hitachi 203 Fluorescence Spectrophotometer replaced the instrument lost in the fire. It has proven to give greater stability and improved wavelength selectivity.

Other fire replacements received were an M.S.E. Super Minor Centrifuge and a Wiley Laboratory Mill. The spectrograph replacement was not received within the year.

The gas chromatograph received originally in 1971 was never fully functional and the suppliers agreed to complete replacement.

Conversion to natural gas was completed for standard items but a number of burners of plastic and glass construction used for digestion of samples for trace elements are outstanding.

The source and type of samples received during the year are shown in Table 2.

TABLE 2
AGRICULTURE DIVISION

	Agriculture Department	Education Department	Public		Public Health Department	Public Works Department	Other	Total
			Free	Pay				
Animal—								
Excreta	246	246
Fat	18	18
Tissue	223	223
Eggs	12	12
Cereal—								
Barley	19	3	22
Oats	10	3	13
Wheat	103	6	109
Various	10	1	12	23
Fertiliser—								
Fertiliser Act	118	118
Various	111	15	...	2	1	129
Horticulture—								
Apples—								
Fruit	69	69
Leaves	531	531
Roots	132	132
Shoots	66	66
Stumps	66	66
Wood	66	66
Citrus	25	25
Currants	36	36
Grapevine	85	85
Peanut Kernels	419	419
Various	797	2	5	...	2	806
Miscellaneous—								
Clay and Clay Products	1	28	29
Oil Seeds	29	20	2	51
Various	1	...	12	1	5	19
Pasture and Fodder—								
Clover	110	110
Feeding Stuffs	131	27	1	159
Feeding Stuffs Act	123	123
Lucerne	50	2	52
Lupin Plant	25	25
Lupin Seed and Meal	152	4	156
Pasture	1,872	1,872
Sudax	36	36
Various	323	12	...	37	10	382
Soil—								
Soil	1,568	35	...	20	4	1,627
TOTAL	7,582	12	12	157	33	22	37	7,855

Animal Nutrition

Cobalt again was the element most called for in diagnostic work on both cattle and sheep, with liver confirmed as the organ of choice for testing, but selenium in relation to White Muscle Disease and ill-thrift continued to be called for. Suspicion of mercury contamination arose with the possibility of the use of treated grain, but in no instance was it confirmed.

(a) In the United States of America selenium is not registered or approved for use in animal husbandry.

In Western Australia, other States and New Zealand however selenium is administered to sheep both as a food additive, in veterinary medicines and by injection, because of deficiencies which occur in pasture in many areas and because it is difficult to improve selenium content of plants by fertilisers.

There existed the possibility that tolerance levels might be imposed on meat imports by the U.S.A. as has been the case for pesticides and some heavy metals.

Although being a natural and essential element it might be anticipated that tolerance levels would be liberal and related to tissue levels in stock on selenium rich pastures (there are areas in the U.S.A. where selenium is so abundant as to be a toxic hazard) it was believed desirable to have some fore-knowledge of tissue levels for treated stock. The content of various sheep tissue is shown in Table 3.

TABLE 3.
SELENIUM IN SHEEP TISSUE.

Tissue	Selenium, Se µg per ml
Blood	0.04-0.35
	parts per million dry basis
Liver	0.22-2.2
Kidney Cortex	4.1-7.2
Muscle	0.25-0.89
	as received
Fat	less than 0.01-0.01

Selenium in the fat (significant possibly because some pesticides tend to be concentrated in fat) is seen to be at the lower limit of determination of this element no matter how high the content of the viscera or blood.

(b) As part of an investigation into the cause of chronic interstitial nephritis in pigs at the Medina Research Station, mercury was determined in liver and kidney. Most samples were less than 0.05 parts per million in the fresh tissue, and the others only up to 0.07, levels showing that mercury was not implicated. A similar occurrence on a commercial property at Narrogin was also shown to be not induced by mercury.

(c) Our finding that whalemeal contained significant amounts of mercury (Annual Report 1971), the possible use of whalemeal for poultry feed, and the knowledge that concentration can take place into eggs and flesh prompted experiments in which whalemeal was fed to both chickens and laying hens.

Mercury in the flesh and liver of control birds without whalemeal was of the order 0.02-0.03 p.p.m. fresh weight, and increased in the flesh to 0.05-0.09 while the liver went to of the order of 0.3 p.p.m. The likely standard for human consumption is 0.05 p.p.m.

Eggs from birds receiving 2 per cent. and 4.6 per cent. of whalemeal in their ration continuously for 6 months, contained 0.04 and 0.10 p.p.m. of mercury respectively, equivalent to 2.3 and 5.1 µg per egg. More extensive testing using whalemeal in the proportions 2, 3, 4 and 4.6 per cent. of the ration gave mean mercury contents of the eggs of test birds at 0.05, 0.06, 0.10 and 0.12 p.p.m.

(d) Rapeseed meal as used for pig feed contains 7 per cent. oil, with a high level of unsaturated fatty acids. The iodine numbers of the fat of 3 pigs receiving rapeseed meal were 46, 47 and 48. Lupin seed meal also contains unsaturated fatty acids in the oil and pigs receiving 15 per cent. of lupin meal gave iodine numbers of 55-60, those receiving 25 per cent. lupin meal gave 59-65 compared with the fat of commercially fed pigs with iodine number 68.

The fatty acid composition of these fats was determined by gas-liquid chromatography in order to provide comparisons and conclusive evidence if any for the increase in unsaturation or production of "polyunsaturated fat".

The composition of the fatty acids is shown in Table 4 and shows that contrary to the results to be expected, but in line with the iodine values, the lupin fed pigs give slightly lower amounts of the unsaturated palmitoleic and linoleic acids.

TABLE 4
FATTY ACID COMPOSITION OF PIG FAT

Ration	Lupin Meal					Commercial	
	15%		25%			68	67
Iodine No.	58	55	59	65	61	68	67
Fatty Acid—	per cent of fatty acids						
Capric (C10·0)	less than 0.2						
Lauric (C12·0)	less than 0.2						
Myristic (C14·0)	1.5	1.4	1.3	1.1	1.2	1.2	1.6
Pentadecanoic (C15·0)	less than 0.2						
Palmitic (C16·0)	27	26	24	26	25	21	23
Palmitoleic (C16·1)	3.0	2.9	2.7	2.5	2.8	4.4	4.6
Heptadecanoic (C17·0)	less than 0.2			0.6	less than 0.2		0.2
Heptadecenoic (C17·1)	less than 0.2			0.6	less than 0.2		0.2
Stearic (C18·0)	15	16	15	12	13	11	12
Oleic (C18·1)	48	44	47	49	51	51	46
Linoleic (C18·2)	4.4	5.9	6.5	6.5	6.2	8.2	11
Linolenic (C18·3)	0.5	0.9	0.5	0.3	0.2	0.9	0.4
Arachidic (C20·0)	less than 0.2						
Eicosenoic (C20·1)	0.6	1.2	0.9	1.3	0.8	2.1	1.4
Eicosadienoic (C20·2)	less than 0.2	0.3	less than 0.2	0.5	less than 0.2	0.3	0.3
Behenic (C22·0)	0.7	0.7	0.3	0.6	less than 0.2		

The code number of the fatty acid indicates the number of carbon atoms and the number of double bonds, i.e., the degree of unsaturation.

(e) Incidental to the checking on effects of supplementary feeding of phosphate to cattle on Fitzroy Pastoral Research Station, both total and inorganic sulphur were determined on the blood plasma which had been preserved with oxalate-fluoride. The range of results expressed in micrograms per millilitre was 800-1020, with a mean of 890 for total sulphur, and 33-77, mean 57, for inorganic sulphur.

Pastures, Fodders and Stock Foods

1. Feeding Stuffs Act.—Of the 101 samples registered under the Act and analysed during the year 77 failed to comply with the registered analysis. The most consistently deficient nutrient was protein, this being found below registration in 31 cases. Excesses were more evenly distributed among 26 instances of phosphoric acid, 25 of sodium chloride, 19 of fat and 15 of calcium.

Mercury and organo-chlorine pesticide residues (by Food and Drug Division) were determined on the 1971 Act samples. Significant levels of mercury were found again in whale products, in imported fish meal and some prepared feeds claiming to be protein concentrates, and in these instances based on whale solubles.

Because the mercury content of some earlier mixed feeds could not at the time be attributed to any particular constituent we had recommended the submission of samples of soya bean meal, fish meal and rock phosphate. Soya meal was exonerated but a sample of fish meal contained 0.27 parts per million of mercury.

2. Clover.—(a) There are a number of concurrent experiments at Esperance, Bramley, Newdegate and North Bannister examining the residual benefits to be obtained from the use of copper and cobalt sulphates. Some of these have been in progress for 6 years, with initial treatments ranging up to 8 lb per acre of the copper salt and 1 lb per acre of cobalt sulphate, with in some cases, an annual 0.5 lb per acre supplementary of copper sulphate.

In general cobalt fertilisation showed no residual effects when the clover on untreated soil was below the critical level beyond the first year of application, but where there was already adequate available cobalt the concentration in the dry matter increased progressively with treatment. Copper behaved similarly in that, although not at deficient levels on any soil, it showed no residual benefit on the same soils which held the cobalt.

(b) A survey of the Gingin district showed satisfactory levels of copper. Only one among 24 properties produced clover as low as 5.6 p.p.m. dry basis, even grass components of other pastures sampled at the same time being greater than this.

Copper survey samples from dairying properties in the Bunbury, Busselton, Capel and Margaret River districts were equally satisfactory.

(c) A problem property at Donnybrook showed response to potassium by pasture, but ill-thrift in stock required a complete survey of calcium, magnesium, potassium, phosphorus, total and inorganic sulphur, copper, cobalt, molybdenum and selenium on 14 samples of components of different areas of clover pastures. Cobalt, copper and molybdenum were not implicated as far as possible deficiencies but selenium was at or near the limit of determination of 0.01 parts per million dry basis in most samples.

The unusual feature was the finding of up to 13 p.p.m. of cobalt and 200 p.p.m. of copper, which together with some low phosphorus figures indicated a complex mineral imbalance.

(d) Low levels of copper and zinc in particular in the 1970 samples of clover cultivars from a grazing trial at Chowerup were confirmed in 1971 samples from the same plots. Cobalt levels were satisfactory at about 0.1 p.p.m. but selenium was only 0.01 - 0.02 p.p.m. at which deficiency could be anticipated. However sheep were said to have

performed markedly poorly on Dinninup clover. This was not explicable purely on mineral composition since that cultivar did not differ materially from the other 4 on trial.

3. Miscellaneous Pastures.—(a) The bulk of pastures analysed were either diagnostic samples in the sense of being suspect of being deficient in elements necessary for satisfactory plant growth or deficient in those trace elements such as cobalt and selenium which are necessary to grazing stock, or from fertiliser experiments testing the residual benefits of cobalt, copper, selenium or zinc.

(b) Native Species.—Much more work than previously was received from the Rangeland Management Branch of the Department of Agriculture where officers are examining the value of various species as fodder, their persistence under grazing, and the health of sheep and cattle grazing on them. Some of the species are rich in protein but whether gathered in the Kimberleys, the Murchison or the Eastern Goldfields, all are very low in phosphorus.

(c) Lupins.—(i) Interest in lupins continued with enquiries both from the Grain Pool and the Department of Agriculture prompted by both the wish to improve overseas marketing and to upgrade lupin meal sufficiently to compete more favourably with imported high protein meal, primarily soya bean meal.

Breeding programs of course have this in mind but the non-shedding varieties are of the order of 10 per cent. lower in protein content than Welko lupins which are more difficult to harvest.

In brief the possible stages of processing for upgrading would be:—

- (1) dehulling—which is already carried out;
- (2) extraction of oil—which is only about 7 per cent. of seed;
- (3) extraction of some carbohydrates and salts with water/alcohol at the isoelectric point to give protein concentrate, or hydrolysis and reprecipitation to give protein isolate.

In the event of a joint project to determine whether lupin products have the potential to replace or more effectively compete with other vegetable protein and oil sources, chemical work is needed on—

- (1) extraction and composition of lupin oil and its by-products;
- (2) production and composition of protein concentrates and isolates;
- (3) effluent disposal or re-use;
- (4) physical effects of lupin meal and flour in cereal products;
- (5) nutritional parameters.

(ii) The sweet lupin cultivars Unicrop and Uni-harvest had been in trials at Badgingarra and Mt. Barker Research Stations under 5 rates of seeding 20, 40, 60, 80 and 100 lb. per acre to give differing plant densities, and at 3 times of planting 6 weeks apart in early May, mid June and late July. It was expected that location and time of planting would influence grain protein level.

Badgingarra proved superior to Mt. Barker by about 2 per cent. protein except from the earliest sowing. Protein analyses at Badgingarra indeed showed no significant variations at all, but Mt. Barker samples showed several effects. The grain from the earliest sowing was the highest in protein, and 4-5 per cent. better than the next best. Protein content fell with seeding rate initially and then improved, 60 lb. per acre giving the poorest grain.

Cereals

1. Barley.—Most barley grain submitted was intended for use as pig feed. In addition we provided analytical certificates to the Grain Pool for shipments of export grain.

2. Oats.—(a) Both the husks and the groats produced by a particular dehulling machine were analysed for the stock food value. The husks were

very low in protein, lower than the groats in carbohydrate and very high in crude fibre so that prospects of exporting this material were not good.

(b) The Western Australian No. 1 Standard Oats for 1972 were analysed for the Grain Pool. Table 5 shows that compared with last year there was an improvement in both protein and carbohydrate (N.F.E.) and also a better kernel content.

TABLE 5
COMPOSITION W.A. No. 1 STANDARD OATS

	1971	1972
	per cent	
Moisture	11.1	9.9
Ash	2.5	2.2
Crude protein (N x 6.25)	7.9	8.9
Crude fat	9.0	6.6
Crude fibre	10.4	9.0
Nitrogen free extract	59.1	63.4
Calcium, Ca	0.06	0.05
Phosphorus, P	0.23	0.23
Kernel content	73.2	76.4
Calorific value	calories per gram	
	4,150	4,620

3. Wheat.—(a) Many of the samples of wheat grain received from farmers were to test the protein content for possible premium quality, and most others were for stock food. Wheaten hay was found to have precisely the same protein content whether cut into windrows and baled on the fourth day, cut by windrower and conditioner and baled on the fourth day, or lastly cut by a Pedrick topper.

(b) Zone samples and sub-samples of Western Australian F.A.Q. wheat grain tested for protein calculated to 13.5 per cent moisture gave 9.27 per cent protein in the F.A.Q. and the zone results were:

Zone	Protein per cent
Geraldton	9.44
Fremantle	9.36
Bunbury	9.30
Albany	8.77
Esperance	9.50

(c) The importance of methods of reporting figures is well illustrated by the case of 10 samples of wheat grain. Eight of these were overseas wheats reported as having high lysine contents. These were compared with two Australian varieties, Mengavi and Eureka, giving results for available lysine shown in Table 6.

TABLE 6

Sample	Available Lysine in Wheat Grain	
	per cent dry basis	g per 16 g N
April (Bearded)	0.33	2.4
Burt	0.29	2.4
CI 5484	0.44	2.3
CI 7337	0.42	2.1
CI 8500	0.48	3.1
Mahratta	0.32	2.8
PI 170217	0.39	2.4
Sharbati Sonora	0.39	2.2
Mengavi	0.36	2.2
Eureka	0.40	2.3

Expressed in grams of lysine for each 16 grams of nitrogen in the grain, which approximates to the per cent of the amino acid in the protein of the grain, the two foreign varieties CI 8500 and Mahratta are seen as superior to all others which fall in the narrow range of 2.1 to 2.4. However when considered purely as lysine in the whole of the dry matter while CI 8500 is still the highest, Mahratta has fallen to below all but one of the others due to its very low protein content.

Horticulture

1. Apples—(a) The association of bitter pit with calcium content was further explored. Tentative conclusions which could be drawn but which require confirmation are—

- (i) for a particular tree, fruit adjacent to pruning cuts or on unpruned laterals did not vary in overall calcium content;
- (ii) there was a decrease in calcium content towards the calyx end of individual fruits. Stem end to calyx end concentrations were in the ratio of 3:2;

(iii) there is a variation in calcium concentration in radial samples taken around the fruit at the equatorial position. This has not been related to the orientation of the fruit on the tree;

(iv) the concentration of calcium in the juice is approximately three-fifths of that in the whole fruit.

(b) Fertiliser experiments continue at Donnybrook, with divided dressings in spring, summer and autumn, confirming again the difficulty of improving phosphorus uptake by surface application. Forms of culture experiments proceeded at Stoneville, these being modified by the introduction of trickle irrigation. Calcium, nitrogen, phosphorus and potassium were called for for all samples on these experiments.

(c) 32 samples of leaves of shoot growth were sampled at Stoneville in January of the first year of a zinc application trial. It is intended to find out which among different modes of application gives the highest zinc accumulation and to see if there are any positive or negative inter-relationships with other elements. Zinc sulphate was sprayed in autumn, winter or spring at 5 and 10, 20 and 40, 1 and 2 lb per 100 gallons respectively on both Granny Smith and Yates. Soil application was in autumn at 0.5 lb per tree either in 8 holes or in a furrow around each tree.

The nutrient concentrations at the beginning of the experiment which will continue for 5 years are given in Table 7.

TABLE 7

NUTRIENTS IN APPLE LEAVES

Variety	Yates		Granny Smith	
	dry basis per cent			
Element	Mean	Range	Mean	Range
Calcium, Ca	1.00	0.78-1.20	1.16	0.99-1.54
Chloride, Cl	0.15	0.13-0.18	0.18	0.14-0.22
Magnesium, Mg	0.35	0.24-0.44	0.33	0.24-0.44
Nitrogen, N	2.14	1.90-2.60	2.36	2.09-2.52
Phosphorus, P	0.18	0.16-0.24	0.17	0.14-0.23
Potassium, K	2.03	1.28-2.52	1.61	0.74-1.96
Sulphur, S	0.17	0.16-0.19	0.16	0.15-0.18
	parts per million			
Boron, B	41	38-53	22	20-38
Copper, Cu	6.8	5.5-9.2	6.8	4.0-8.8
Manganese, Mn	35	23-50	34	20-44
Zinc, Zn	15*	11-21*	13*	11-14*

* Values of 60 and 69 for Yates, 45, 54, 97 and 136 for Granny Smith have been omitted since they were found in spring treated leaves and possibly resulted from contamination.

Because of the contamination suggested for the samples taken in January, 8 of the trees including those for which the high results were obtained, were re-sampled in the spring prior to the second application of the spray. All gave results between 10 and 13 parts per million dry basis. Comparison of these with the tabulated figures has to be tempered by other work (Annual Report 1971) which showed that zinc rose to a maximum concentration in January.

(d) At the rates used (up to 3lb of methyl bromide per 1,000 cubic feet) apple fruit which had been fumigated were well below the export limit of 10 parts per million of bromine.

See 2 Citrus (b) below for further details.

(e) The principle of "little and often" appeared applicable to the use of compound NPK fertiliser for young apple trees. Planted in 44 gallon drums these gave the greatest foliar concentrations of nitrogen, phosphorus, potassium and calcium when the fertiliser was applied as 3 separate surface dressings. Incorporating this type of fertiliser into the soil below the trees before planting, or a combination of both methods, was not so successful. A particularly significant feature of the experiment was the success in obtaining uptake of phosphorus from the soluble phosphate with the high rates of 1,000 g and 1,500 g of fertiliser per tree. Translocation of this result to the field should be an interesting future development since experience has been that only deep placement of the older type of phosphate fertiliser has had any effect on leaf levels of phosphorus.

2. Citrus—(a) Samples from the Gascoyne Research Station of leaves of a number of citrus on various rootstocks again illustrated the problems with irrigation at Carnarvon. A number of nutrients were found to be deficient, which is easier to remedy than the high to excess levels of chloride, sodium and boron, the combined effects of which are likely to inhibit successful production.

(b) A number of citrus fruit samples were tested for bromide content. The Japanese have an import restriction limit of 10 parts per million in whole fruit and since alkyl-bromides are used in fruit fumigation it was of importance to see what concentrations build up in the fruit, and whether these would be converted to inorganic bromides or fixed organic forms which would be retained when the fruit reached Japan.

Many of the samples received were marginally above the required limit and indications were that the bromide was stabilised either by conversion to inorganic forms or by solution in the oils primarily in the skins of oranges and mandarins.

3. Grapes—(a) It is hoped that completely new vine growing industries will prove possible in other than the Swan Valley but each is likely to have its own problems. One such which was confirmed with respect to the new venture at Frankland River was the low level of potassium which had caused marginal scorch. Another arose on a vineyard on coastal sand, but a variety of chlorotic symptoms were not so readily explained when apparently healthy foliage in a number of instances contained less of the nutrients believed deficient than did the unhealthy leaves. Three samplings at monthly intervals did not help solve the riddle.

(d) The dried currants from vines receiving spray treatments with growth regulatory substances were shown to have a tendency to be slightly more moist for a given drying period, due probably to the greater size of the berries, and also to have a very slightly higher sugar content than currants from vines which were cinctured to obtain fruit set.

4. Peanuts—419 samples of peanut kernels from Kununurra were analysed for protein, oil and free fatty acid contents which are all properties used in quality assessment for either food or confectionery. The samples were derived from a number of experiments involving use of fungicides, varieties with differing fertiliser rates, varieties with differing times of digging following two times of planting, uses of herbicide, and planting dates for different varieties. Following the lifting by Japan of import restrictions other than those based on quality a potentially valuable market was opened up.

Fertilisers

1. Fertilisers Act—(a) The 130 samples received for testing under the Act were only one half of the number of the previous year. Certificates of analysis were issued for 137 samples, including 40 covering samples received in 1971, and 33 were carried forward.

Deficiencies were found in 47 of the reported samples, and a total of 96 individual deficiencies. Many of the deficiencies were found in the compound mixtures used in horticulture and home gardening. The accurate mixing of many constituents requires very careful production control and the probability of error increases the possibility of individual nutrients being found to be deficient. The natural desire of a manufacturer to claim as high a content of each nutrient as possible in his registered analysis should be tempered by the knowledge that his product is the more likely to fail to meet the claims made for it.

An illustration of this was provided by 6 samples of mixtures intended primarily for garden use, each of which had 13 individual constituents registered, and had 9, 8, 6, 5, 5 and 4, or a total of 37 deficiencies. Thus these 6 samples accounted for more than one third of the deficiencies found during the year.

(b) Because the Fertilisers Act provides only for the sampling of packaged fertilisers, bulk deliveries of superphosphate are not subject to its provisions. The sampling of fertiliser being loaded directly into trucks, whether for rail or road transport, is currently under study to provide data upon which the optimum sampling intensity for any level of sampling accuracy will be calculated.

Sixty-four samples of bulk super copper zinc molybdenum No. 2 had been collected using a stream sampler while a ten ton bulk load was being delivered into a truck. Each of 32 stream samples had been riffle split and 2 sub-samples directed to both these Laboratories and the manufacturer. Duplicate determinations of total phosphorus, copper, zinc and molybdenum on each of the sub-samples were carried out to allow a statistical evaluation of variations between samples and between analyses.

Total phosphorus, copper, zinc and molybdenum in such a fertiliser are registered at 20.5 per cent phosphoric anhydride, P_2O_5 (equivalent to 8.95 per cent phosphorus, P), 0.33 per cent Cu, 0.30 per cent Zn and 400 parts per million Mo. The means of the 128 analyses for each element in the 32 stream samples were 9.98, 0.369, 0.382 and 388 respectively.

2. Crayfish offal was analysed for calcium, nitrogen, phosphorus and chloride, see Table 8. The material was free for the carting but of dubious value since it would have to be buried in order to retain most of the nitrogen, its most valuable nutrient, and because of its wet condition.

TABLE 8
CRAYFISH OFFAL

	as received	drained solids		liquid
		per cent		
Calcium, Ca	3.45	4.22	0.12	
Nitrogen, N	2.05	2.14	1.65	
Phosphorus, P	0.20	0.24	0.04	
Chloride, Cl	0.91	0.83	1.26	

A further possible use for cray offal was the suggested production of an edible paste for flavouring. A sample of such paste did not inspire confidence because of its green-brown colour, although on the basis of apparent protein content it would be quite nutritious.

3. There was a good variety of other materials examined as potential fertilisers. Brief comments on the source of these are—

- bone black—with phosphorus content of 16.2 per cent but in forms not readily available;
- sewage sludge from septic tanks—very similar in composition to that from major Metropolitan Water Supply Treatment plants but with even less potassium;
- mulch residues from mushroom growing—very similar composition to animal manure;
- brewery sullage—acid reaction, pH 4.0 and very low in nutrients;
- lake deposits—shown to be largely gypsum of various purities;
- deep litter—several samples, some for use as such, others for admixture with high analysis fertilisers for resale.

Oil Seeds

(a) Climatic factors can be expected to influence the composition of the oil extracted from oil seeds. Rapeseed grown at Kununurra provided an opportunity to test this by comparison with a similar variety growing in the south of the State. The other seeds, safflower and linseed, which have never achieved the commercial success in the south which

rapeseed has recently, were also grown at the Kimberley Research Station. The analyses of all three are shown in Table 9.

TABLE 9.
OILSEEDS FROM KUNUNURRA.

	Arlo Rape	Safflower as received per cent	Linseed
Moisture	5.1	4.8	5.4
Oil	35.0	32.4	35.0
Crude protein (N x 6.25)	25.4	16.5	24.6
Fatty Acid Composition :-			
	per cent of fatty acids		
Palmitic (C16-0)	3.0	6.4	6.5
Stearic (C18-0)	less than 0.3	2.8	8.4
Oleic (C18-1)	28	12	30
Linoleic (C18-2)	16	78	12
Linolenic (C18-3)	6.3	42
Eicosenoic (C20-1)	11
Erucic (C22-1)	33
Nervonic (C24-1)	1.8

Palmitoleic (16.1), arachidic (20.0), eicosadienoic (20.2) and lignoceric (24.0) were also detected in the rapeseed at less than 0.3 per cent.

Comparison with Arlo rapeseed grown in the Great Southern (see Annual Report 1971) shows that the Kimberley rapeseed has much less of the higher molecular weight acids erucic and eicosenoic and a corresponding increase in oleic and linoleic acids, although there is a contrasting increase of nervonic acid from a just detectable amount to 1.8 per cent.

The oil content is poor at 35 per cent, about 10 per cent less than to be expected in the south, and there is a compensating increase in protein to 25 per cent compared with a usual 18-20 per cent in the south, but the extracted meals would be of about the same composition.

(b) Further interesting comparisons of fatty acid composition are shown for the varieties Oro and Masoweiki and the related weed Wild Turnip in Table 10. For comparison a composite sample of the rapeseed deliveries for the 1971-72 season is given.

This composite sample contained 46.0 per cent. oil and 5.7 per cent. moisture.

The influence of the low erucic acid containing varieties had not been seen on commercial crops at this stage, but the way in which principally oleic acid builds up as erucic acid is diminished is clearly evident.

(c) Safflower, sunflower and rapeseed were under agronomy trials at Eridu out of Geraldton, and the harvests were compared for oil and protein content. Rapeseed was comfortably superior to each of the others on both accounts and had the added advantage of yielding well.

(d) We provided certificates of quality of rapeseed shipments out of Albany and Esperance for the Grain Pool.

Discussion on the values for oil content arose over divergent results obtained on separate subsamples in commercial laboratories. These arise due to different extraction procedures using different solvents. In the absence of agreed methods of analysis which for their mutual protection should be part of the contract of sale between vendor and purchaser, our certificates state the procedure and solvent used.

Soils

(a) Similar experiments testing the effects on soil fertility and soil structure of long term rotations of cereal crops and leguminous pastures are running at Wongan Hills, Merredin, Chapman and Newdegate Research Stations. That at Wongan has been in existence since 1956 and the others are more recent and each is adapted to local practice in their districts. Soil samples are analysed each year for some of pH, nitrogen, organic carbon, cation exchange capacity and exchangeable cations and mechanical analysis, depending on the stage of the experiment. The soils at Merredin present an apparent anomaly in that they are not base saturated although they have a neutral pH.

(b) The 3 mm layers obtained by mechanical sweeping were taken from sites on 18 different farms to estimate the probable effects of erosion on wheat yield. The samples were analysed for nitrogen, total phosphorus and bicarbonate soluble "available" phosphorus. Both nitrogen and phosphorus tended to be more concentrated in the uppermost layer in most instances but there were examples of both in even distribution down the profile, and 2 exceptional samples where the nitrogen unlike phosphorus was found highest in the second 3 mm layer.

(c) The effect of soil fumigation with a mixture of chloropicrin and methyl bromide was to cause build up of ammonium nitrogen because of inhibition of nitrification, as shown by samples taken at Wongan Hills in August from plots under both pasture and wheat. By mid-September however the fumigated soils were very similar to the untreated plots in the pasture areas, but the plots under wheat in both September and November were still marked by high ammonia.

(d) Soils from many other experimental sites included those concerning the failure of dams at Badgingarra, the establishment of Townsville Stylo at Kimberley Research Station, 9 sites testing the maintenance of phosphorus and sulphur levels, obtaining preliminary information on the soils to be irrigated at Dunham River.

TABLE 10.
FATTY ACID COMPOSITION OF RAPESEED AND WILD TURNIP OILS.

	Wild Turnip	Rapeseed		Composite 1971-72
		Oro	Masoweiki	
		per cent of fatty acids		
Palmitic (C16-0)	3.0	2.7	2.0	2.2
Palmitoleic (C16-1)	less than 0.3	
Stearic (C18-0)	0.6	less than 0.3	
Oleic (C18-1)	8.3	45	24	22
Linoleic (C18-2)	12	18	16	15
Linolenic (C18-3)	9.8	8.9	8.8	8.0
Arachidic (C20-0)	less than 0.3	
Eicosenoic (C20-1)	7.0	9.9	12	11
Eicosadienoic (C20-2)	less than 0.3	
Behenic (C22-0)	less than 0.3	N.D.	N.D.	N.D.
Erucic (C22-1)	55	6.2	34	42
Lignoceric (C24-0)	1.9	5.2	1.0	less than 0.3
Nervonic (C24-1)	2.6	1.7	1.8	less than 0.3
Tetracosadienoic (C24-2)	N.D.	2.2	less than 0.3	less than 0.3

N.D. indicates not detected, the limit of detection being approximately 0.1 per cent.

Air Pollution

1. Monitoring of peppermint tree leaves and pastures around the fertiliser works at Picton continued, with sampling at two-month intervals and analysis of washed and unwashed leaves for both fluoride and chloride. Washing removes any dust which may contain fluorides and gives a better indication of the fluorine absorbed by the leaves, but pasture is not washed since it is the fluoride ingested by cattle which is the primary concern on grazing areas.

In spite of improvements to scrubbing of flue gases, improvement in fluoride concentrations continue to be dominated by seasonal effects and regrowth.

The peppermint tree, ubiquitous to the district, has readily identified successive flushes of growth and is readily sampled from the one tree at each site. It is also not highly sensitive to fluorine as shown by values of the order of 1,000 parts per million dry basis in older leaves of trees within the works grounds, and for which new leaves gave values only one third or one quarter as high.

Controlled by the winter rainfall washing and the flush of spring growth, pasture samples varied from about 5-10 p.p.m. during spring up to 120 p.p.m. for the dry summer grazing on the nearby property. There were many samples giving results of 30 or more parts per million in the dry matter of the pasture, levels which would induce fluorosis in stock permanently grazed. Urine from cattle on this same property showed a parallel fluctuation rising to 15-26 micrograms per millilitre in summer compared with less than 5 during spring.

2. In view of the known effects from fluorine from brickworks with large outputs a joint inspection was arranged with officers of both the Public Health and Agriculture Departments and carried out on the surroundings of other brick producers and also those with other clay products such as tiles and sewerage pipes. These were located both in the inner and outer metropolitan area.

In some instances there was no evidence of damage to foliage of street trees or home gardens or native trees but because of leaf symptoms seen during this inspection subsequent leaf sampling was carried out at Armadale, Belmont, Byford, Caversham and Midland Junction. Analyses were for fluoride, chloride, and sulphate because the scorching effects from sulphur dioxide and fluorine from flue gases and soil or water salinity are both difficult to distinguish and believed to be not only cumulative but synergistic.

Because at Byford pastures on a dairy farm were seen to be involved a program of sampling was started and continues with sampling of native trees, pastures and cattle urine.

3. As an aid to the Scientific Officer, Clean Air who was attempting to correlate his flue gas readings for fluorine with actual losses of fluorine during the firing of clay products, samples of raw clay and of unfired and fired bricks, tiles and pipes were analysed.

Clays and shales in use in the Midland Junction-Caversham area are generally lower in fluorine than those used further south, the respective figures being 120-240 parts per million compared with a range of 430-660 p.p.m. Depending on the heat and retention time in the kilns and the nature of the clay minerals the fired product may be almost free of fluorine; bricks are generally very low but have had up to 80 p.p.m. after firing, and tiles have been recorded up to 140 p.p.m.

The extent and degree of the effects of gaseous fluorine effluents will be determined not only by the level in the raw materials but also by the output of the kilns, the efficiency of dispersal of the flue gases which in turn is dependent on many factors including local weather patterns and topography, and the sensitivity of the plants and stock absorbing the fluorides.

4. We received leaf samples of a variety of native trees growing in the Kwinana-Coogee area. These were for chemical work to help distinguish

what contribution air pollution from fluorides, sulphur dioxide, heavy metal dusts or alumina dust, or damage from salt spray may have had in addition to other contributors to leaf damage such as wind, moisture stress and insects. Some high levels of aluminium, chloride and inorganic sulphur were found in individual samples but fluoride was not found at significant levels.

5. Concern for damage to grapevines in the Swan Valley continued, samples being submitted on a number of occasions not only from vines just across the river from the major works, but also from vineyards of more remote major producers following unusual weather patterns when it was possible that flue gases may have spread further and in greater concentration than is usually the case.

Samples from parts of the valley other than near Midland provided comparison analyses, with much lower levels of fluoride. Manganese was also determined in some samples because of possible uptake from acid soils at depth.

Miscellaneous

1. There were 77 samples of post mortem blood for the determination of alcohol by the Kozelka and Hine method for the purpose of internal checking.

2. The native plant *Hybanthus floribundus* had been reported in the literature as being capable of taking up an extraordinary amount of nickel. The opportunity was taken of testing two samples of the plant, one collected at Merredin in the wheat-belt and the other at Orabanda, a highly mineralised area. As shown in Table 11 the nickel content of the Orabanda sample was at a concentration to be expected of a major nutrient element.

TABLE 11
Hybanthus floribundus

	Merredin		Orabanda	
	twigs	leaves	twigs	leaves
	per cent			
Ash	2.4	3.7	1.7	3.6
Nickel, Ni	0.016	0.020	0.18	0.38
	per cent of ash			
Nickel, Ni	0.67	0.54	11	11

3. Blood samples from the Red Cross Blood Transfusion Service were analysed for aluminium content to ensure that there was not any aluminium taken up from the aluminium flasks used in storage.

ENGINEERING CHEMISTRY DIVISION

The Division's activities have centred on laboratory and pilot plant experimental work with the emphasis again very much on projects sponsored by outside organisations, companies and individuals. When time has permitted some progress has been maintained on selected internally innovated projects, which are chosen for long term benefits and are assessed to be of general importance to the development of the State's resources.

A total of 170 samples was registered to the Division during the year—again an increase over all previous years. Although many of these registrations were for samples submitted for determination of physical and chemical properties of fuels, coals, oils, gases and feeding stuffs, the main effort was directed to a core of larger scale projects, which were representative of a range of minerals and raw materials.

The accent in the majority of these larger projects was on testing at pilot plant level to gain information on the potential of the various processes under continuous operating conditions and to provide design data for scale up and subsequent commercialisation. The Division's 16 feet long and 14 inch internal diameter rotary kiln was the central unit in much of this pilot plant work.

Staff and General

Apart from one appointment and one resignation at Project Leader level, there were no staff changes during the year and this assisted the continuity of the work output. Mr. T. J. George took up duties as a Chemist and Research Officer in August, but in the following month the resignation of Mr. P. F. Rolfe again left the Division below strength in this important area. Negotiations for a replacement were nearing completion at the end of the year.

Mr. L. Brennan continued his activities as the fuel technologist member of the Scientific Advisory Committee appointed under the Clean Air Act, which is administered by the Public Health Department. In this role he attended in excess of 20 meetings, including sub-committee meetings related to specific aspects of air pollution such as fluoride emissions and incinerators. As well an extensive range of matters arising from the Committee's statutory functions required on site technical appraisals and discussion.

Mr. B. Goodheart continued as Western Australia's non voting representative on the Board of Directors of the Australian Coal Industries Research Laboratories, which comprises a system of five laboratories functioning in general coal technology and research.

Conferences and Field Trips

Mr. L. Brennan attended the biennial Conference of the Institute of Fuel in Canberra in November and visited kindred research laboratories in Sydney.

Mr. P. Rolfe visited C.S.I.R.O. Laboratories while on a visit to Melbourne in April.

Mr. B. Goodheart attended an Institute of Engineers Symposium entitled "Perth Polluted or Perth Pleasant" in September and made a field visit to the South West Mining centre of Capel, Greenbushes and Collie in December.

Buildings and Equipment

The increasing concentration on investigations at pilot plant level underlined some deficiencies in the Division's equipment and facilities, and these were rectified where possible.

A mobile, inclined variable speed conveyor capable of conveying bagged, lump or powdered material to vertical heights of approximately 12 feet was acquired to assist in the handling and transporting of bulk materials and samples.

Bulk sample storage facilities were upgraded by modifying and reconditioning a set of hoppers that were previously part of the structure erected many years ago for coal carbonisation studies.

Near the end of the year an order was placed for the supply of a large cabinet type, multi tray cross flow electric drier to satisfy requirements in this important aspect of feed and product preparation.

The need for an increased output and a higher purity supply of high pressure air for process use was met by the installation of a two stage Ingersoll Rand air compressor. This new unit will supply 50 cubic feet of air per minute at 100 p.s.i.g. and is fitted with an after cooler.

Because the main pilot plant building is fully committed to the permanent siting and utilisation of unit equipment, there is no all weather area suited to crushing, sizing, blending, pelletising and general processing of bulk materials and consideration has now been given to formulating an appropriate extension to the main building for this purpose.

A 3½ inch diameter, laboratory sized, stainless steel microniser or fluid energy mill was fabricated to the Division's design during the year. Performance trials carried out so far have confirmed its capability of milling a variety of feed materials down to the low micron size range and that the unit will have application to a wide field of project work.

Investigational Projects

Investigations carried out under a "Public Pay" heading at the request of clients remain confidential to the client and only the broad aspects of these projects can be reported.

Vanadium.—Continuing growth in the world demand for vanadium has directed increasing attention towards its recovery from titaniferous magnetites. In Western Australia there are several vanadium bearing titano-magnetite deposits of potentially commercial interest and the Division accepted requests for work on samples from three such deposits during the year.

These vanadium studies were a re-association as some years previously the Division had mounted an extensive Departmental investigation on evaluation of processing methods applicable to the Coates deposit (Reference Annual Reports 1963-1968).

The vanadium in titano-magnetites does not normally occur as discrete material and is locked within the magnetite structure or its alteration products such as martite. However, physical beneficiation methods such as gravity and magnetic separation can usually be applied to produce a concentrate with upgraded vanadium values. Two of the sponsored projects were directed at these beneficiation studies.

The major investigation involved continuous pilot plant scale testing of the roasting stage of an established vanadium extraction process, with suitable modifications for local conditions and ore body. Several bulks representing differing feed concentrates and ore categories were roasted under a range of strictly controlled conditions to produce the desired vanadium containing products.

A large bulk sample of typical product was prepared and despatched to the United States of America for specialised recovery trials.

A programme of small scale laboratory testing was carried out to supplement the kiln trials and the overall programme verified that the extraction process under test was applicable to the raw materials.

Some Divisionally backed studies were made to explore other extraction techniques and to provide data on established recovery methods. The precipitation of standard vanadium products such as sodium hexa-vanadate and ammonium metavanadate from solutions prepared by percolation leaching of typical calcines was examined on a laboratory bench scale.

Ilmenite upgrading.—Late in the year, a beach sand mining company announced that it would proceed with the building of a fully commercial upgrading plant based on a process first developed by the Division in the early 1960's. Considerable effort has been expended by the Division towards refining and improving many aspects of this process over the intervening years and this continued in 1972. Examination of a sulphur doping variation aimed at enhancing final product quality continued (Annual Reports 1970, 1971) and preparations were made for submission of a publication on this topic to the 1973 Conference of the Australasian Institute of Mining and Metallurgy.

At the request of a local Company, experiments were carried out to determine the rate controlling mechanism for the aeration stage of the process. The 120 gallon capacity, stainless steel reactor vessel with variable speed agitator unit was used in establishing the solids suspension characteristics and assessing the influence of varying system conditions.

The results of some of this work were incorporated into a paper on ilmenite upgrading submitted by personnel of the Sponsor Company to the 101st annual meeting of the American Institute of Mining Engineers in San Francisco early in the year.

Gold Recovery.—The rising price of gold contributed to a general rejuvenation of interest in the processing of lower grade deposits and the re-treating of tailings material for gold recovery.

A programme of pilot plant testing was undertaken at the request of a local Company, which aimed to recover gold from refractory tailings dump material. Previous laboratory trials had shown that the process under scrutiny held promise and the pilot scale work was required to establish applicability to continuous operation and to provide data for engineering design and scale up.

Reports on the first stage of testwork were in preparation at the end of the year and these verified our original contention that there was a need to direct further attention to the method of product recovery.

Processing and Utilisation of Diatomaceous Earths.—The demand for filter aid material continued to rise along with the rate of installation of swimming pools and the Division received many enquiries regarding the possibility of processing locally occurring diatomite deposits to substitute for the use of expensive imported materials.

Several small projects were undertaken to satisfy these enquiries before it was decided that overall interests would be better served by the mounting of a general Departmental research programme—the results of which would be available to all.

The programme was framed to include:

- (i) Basic studies—analysis and identification.
- (ii) Laboratory and pilot scale investigation of beneficiation and processing.
- (iii) Utilisation, costing and plant design—the emphasis being on utilisation potential and its relationship to physical and chemical properties and the significance of product specifications.

Diatomaceous earth deposits are common in the South-West of the State. The deposits are of recent geological age and occur mainly in the beds of lakes and swamps and consist of diatoms of varying degrees of purity. There has been some spasmodic commercial utilisation—particularly based on deposits in the Lake Gnangara region.

The Departmental study was initiated by requesting public assistance in the furnishing of suitable samples. Bulk samples were received from 20 different deposits and these were representative of areas ranging from south of the Perth metropolitan area through to deposits approximately 200 miles north of Perth.

A preliminary analytical and identification programme has been completed on all 20 samples and this has enabled the selection of head materials for beneficiation and processing studies.

The chemical analyses showed that the silica content (on an ignited basis) was more than 88 per cent for most samples—the highest being 98.3 per cent. However, silica in non-diatom forms such as spongolite, sand and silt was present in varying degrees, together with other impurities such as iron oxides and water soluble salts. Microscopic examination was used to establish the diatom genera and the relative abundance of intact structures. The samples initially selected for processing studies were those containing a favourable assemblage of diatoms and those in which the deleterious impurities may be removable by beneficiation.

Beneficiation techniques explored to date have been based on de-agglomeration followed by air classification. Straight and flux calcination has been shown to be effective in aiding impurity removal and controlling physical properties. Dry processing has been chosen for pre and post calcination treatments.

Cobalt and Nickel recovery.—This investigation which was sponsored by a local Company to evaluate possible methods of recovery of separate cobalt and nickel salts from refinery tailings, was carried over from 1971 and terminated in the early part of the year. Two processes, one based on pyrometallurgy and the other on hydrometallurgy were found to be worthy of further testing, but changes forced on the Sponsor Company ruled out

the possibility of its sponsoring of Stage II work. To clarify certain points and to provide a basis for a generalised costing of the two possible processes, some additional work was carried out on a Departmental basis, and an addendum report, inclusive of costing was prepared for Departmental filing.

Mineral sands.—An investigation was undertaken at the request of an engineering firm to provide the information necessary for the design of a commercial scrubbing unit, which was to be part of the treatment circuit for a new heavy mineral sands industry. The testwork evaluated the liberation of loosely bound slimes from mineral sand agglomerates and yielded data for determination of the optimum time and intensity of scrubbing.

Vermiculite.—An investigation of the beneficiation and utilisation potential of three bulk samples of vermiculite type material commenced late in the year at the request of a Perth manufacturing company.

Coals and related materials.—Several samples of coal, char and lignite were received and a range of analyses performed. Collie continues to be the only indigenous source of coal for commercial use. Coal from this area is processed in a rotary kiln at Collie for export as char, and some analyses of the export material were done. In addition, work was requested in relation to ancillary uses of the processed coal. This investigation, which has involved the determination of the characteristics of products prepared under various conditions with a range of additives, is continuing.

Samples of carbonaceous material from two areas in the South West of the State were submitted for analysis. Two of the samples were from Permian coal measures at Watheroo and were recovered from a water bore. A comprehensive range of analyses was carried out to provide a record of the characteristics of the coal against a possible future requirement when the coal itself would not be readily available. The main analytical results were as follows:

Lab. No.	8179		8180	
	as received	dry mineral matter free	as received	dry mineral matter free
per cent				
Proximate analysis—				
Moisture	18.1		18.9	
Ash	10.2		11.7	
Volatile matter	29.3	41.6	29.2	42.9
Fixed carbon	42.4		40.2	
	100.0		100.0	
Ultimate analysis—				
Carbon	55.0	78.0	54.0	79.3
Hydrogen	4.1	5.8	3.9	5.7
Sulphur	1.1		0.8	
Btu per lb				
Calorific value	9,590	13,600	9,270	13,610
Caking properties		nil		nil

In addition analyses were carried out on the ashed and carbonised residues and on the gases liberated during carbonisation.

Other samples were submitted to establish the commercial value of lignite from the Fitzgerald River area. Determinations of specific gravity, proximate analysis and calorific value were made, and these results were ancillary to estimations of the montan wax content of the lignites carried out by another Division of the Laboratories.

Several samples of coal chips recovered in drilling for oil were submitted by an exploration Company. The analyses requested were to enable the rank of the coal to be determined. Knowledge of this characteristic of the carbonaceous material recovered from such bores aids in determining the thermal history of the strata and interpreting the results of the drilling. One parameter which assists the determination of coal rank is "equilibrium moisture" measured according to A.S.T.M. D 1412.

The technique was made available following a request but is not normally used in routine analysis. These Laboratories are investigating the possibility of providing reflectance data for such samples because this data renders the determination of rank more certain.

During the year, work was completed on fifty seven coal samples taken from bore holes in the Perth basin and received from the Geological Survey during 1971. Many of these samples exhibited desirable commercial properties, for example, caking and swelling characteristics, but there are no indications of commercially exploitable quantities of these coals.

An exploration Company requested data relating to the moisture contents of coal samples in the "as analysed" condition. The samples referred to had been analysed between 1950 and 1956 and an extensive search of the records provided the required information.

Miscellaneous.—Seventy five samples of feeding stuffs, feed residues, cereals and metabolic residues were received from the Agriculture Division for determination of calorific value. The results are used by the Agriculture Department in studying the growth rates and metabolism of animals.

Three samples of oil were received. One was for determination of sulphur in connection with a corrosion problem and the other two were for determination of chemical composition and energy content in relation to boiler acceptability trials.

Samples of gas were received from various sources. Twenty-five related to matching a specified oxygen content in helium-oxygen mixtures used in maintaining under water divers. Two related to mine atmospheres and four were connected with an emission of gas encountered in exploratory drilling. Some methane was present in these latter samples.

Several small beneficiation studies were carried out on request. For example, a gravity—electrostatic-magnetic separation technique was defined for the upgrading of a wolframite concentrate (produced in a State Battery) to an acceptable market grade.

Consultative and Advisory

The Division continued its normal function of providing information on matters relevant to its sphere of activities. Typical of the subjects covered were advice as to the feasibility and controlling parameters for in situ leaching of copper ores, the modifying of process conditions and the blending of clays to optimise the output of a country brickworks and procedures available for casting magnesium anodes from ingots.

Among the overseas and interstate visitors to the Division during the year were:

- Mr. K. Mohanty—Government Geologist, Orissa State, India.
- Dr. G. van Doornum—Chief, Engineering Division of Fuel Research Institute of South Africa.
- Dr. K. McG. Bowling—Principal Research Scientist, C.S.I.R.O. Division of Mineral Chemistry, Sydney.
- Dr. J. McKay—Manager, Metallurgical Services, Consolidated Gold Fields Australia Ltd., Sydney.
- Mr. K. Lindsay—General Manager, British Oxygen Ltd. (Minerals), London.
- Mr. R. Hoshakawa—Metallurgist—Mitsui Company, Japan.
- Mr. S. A. McCarrol—Metallurgical Consultant, Las Vegas, U.S.A.
- M. R. Iwasaki—Metallurgist, Nippon Denko Co of Tokyo, Japan.
- Mr. T. Marshall—Deputy Director, Chemistry Division, Department of Scientific and Industrial Research, New Zealand.

Mr. K. Chant—Metallurgist, Anglo American (Aust) Ltd, of Melbourne.

Dr. W. Walker—Assistant Officer in Charge—Chemical Metallurgy Section, Australian Mineral Development Laboratories, Adelaide.

FOODS, DRUGS, TOXICOLOGY AND INDUSTRIAL HYGIENE DIVISION

Following the pattern which has developed in recent years, the work of the Division in 1972 was concerned chiefly with samples from the Departments of Agriculture, Police and Public Health. Although the numbers were lower in comparison, the other principal sources of samples were the Western Australian Trotting Association, the Department of Fisheries and Fauna, sundry Hospitals, and those samples classed as Pay Public.

The major factor affecting the work of the Division throughout the year was a fire which occurred during the evening of 8 January, 1972. As a result of fire damage the whole of the original Division, completed in 1942, and the extensions made in 1962-63, had to be re-built internally, after the roof had been replaced. Whilst most of the interior of the "new extensions", completed in 1966, did not suffer directly from the fire, damage in the roof disrupted services to the benches, and the effects were felt intermittently in the "undamaged" area for some months. Two rooms were out of action for bench work for approximately 8-9 months, but by the end of the year all of the Division had been re-wired electrically, all service points on the benches renewed, and the whole re-painted.

Major items of equipment destroyed, or so damaged by fire and water as to require major repair, included two gas chromatographs, an ultra-violet spectrophotometer (double-beam recording), two infra-red spectrophotometers and a large quantity of accessories, as well as less costly equipment such as Haldane and Graham-Lawrence gas analysers, Hortvet cryoscope, constant-temperature waterbath, high-speed homogeniser, polarimeter, a built-in electrolytic Marsh-Berzelius unit, and numerous items of normal laboratory equipment. Infrared spectrograms of many chemicals, drugs, and other substances, compiled as reference "standards" over the past ten years, were also destroyed.

Temporary accommodation for some classes of work was found in other Divisions of the Laboratories, but for two-thirds of the year the bulk of the work was carried out in the circumscribed conditions of the undamaged area of the Division.

Thanks to the efforts of the Public Works Department and ancillary services, it was possible to transfer staff and equipment back into the re-built area during August and September, although some workmen were still on the premises up to the end of the year.

Thanks are recorded to all who contributed to this fine effort of reconstruction.

Samples—Five thousand two hundred and eighty one samples were received during the year, being a decrease of 9.1 per cent on the number received in 1971, but 15.9 per cent greater than in 1970. The number of samples still "in hand" at the end of the year was 1054 compared with 816 "in hand" at the end of 1971.

Table 12. shows the source and condensed description of samples received during 1972.

Foods

The number of samples of food received during the year was the highest on record, one thousand one hundred and twenty-nine, and represented an increase of thirty-five per cent on the number received in 1971. Of these, 165 were samples of cows' milk submitted by the Milk Board of Western Australia for checking against the chemical standards prescribed by the Milk Act Regulations. Owing to loss of equipment destroyed by fire, only 97 of the samples were subjected to the Hortvet

TABLE 12
FOODS, DRUGS, TOXICOLOGY AND INDUSTRIAL HYGIENE DIVISION

	Agriculture Department	Fisheries & Fauna Department	Hospitals	Labour Department	Milk Board of W.A.	Mines Department	Pay Public	Police Department	Public Health Department	Public Works Department	State Tender Board	Western Australian Trotting Association	Other	Total
FOODS—														
Bread				3		10			3					16
Eggs									16					16
Fruit Juice	47		2						49					110
Liquor									71		12			72
Margarine								1	14					14
Meat						4			34					38
Milk	8				169	1	1		76					255
Peanuts	36													36
Seafood		11					1		433					450
Various	6		50			7			58				1	122
INDUSTRIAL HYGIENE—														
Blood							12		4					16
Dust									11					11
Urine				93		18	73		31				5	220
Various						8			23				3	34
MISCELLANEOUS—														
Animal Bait								13						13
Animal Tissue	215	113							2					330
Criminal Cases						4		168					1	173
Crockery									24					24
Detergent			1								106			107
Drugs								89	2					95
Horse Doping						2						4		211
Maritime Pollution							6	39				209		45
Pasture	206													206
Pesticides	55					2			2	28				87
Soil	69								1					70
Water	11	9				10	3		27	24			2	86
Whale Meat									22					22
Various	50		14			31	2		44	3			8	152
TOXICOLOGY—														
Animal	34	3					6	1						44
Human—														
Toxicology			4					1,017	2					1,023
Sobriety							197	461						658
Traffic Death								379						379
Specimen from Patients			98				26	1	19				2	146
TOTAL	787	136	169	96	169	97	327	2,169	973	55	118	213	22	5,281

freezing point determination. Nine per cent of the samples contained less than the legal minimum of milk fat (3.2 per cent), and 77 per cent contained less than the legal minimum of solids not fat (8.5 per cent), while 78.4 per cent of those examined for freezing point failed to comply with the legal standard (0.540 degree C below zero). The proportion of samples failing to comply with chemical standards is higher than in 1971, but in presenting these figures it is emphasised that these analyses apply to Inspectors' samples, for which there was *prima facie* evidence of non-compliance with legal standards.

The distribution of analytical figures is shown in the following Tables:

Milk Fat	
Per cent in sample	Per cent of total samples
Less than 3.00	3.6
3.00-3.19	5.4
3.20-3.49	9.1
3.50-3.74	23.7
3.75-4.00	19.4
More than 4.00	38.8
	100.0

Milk Solids not Fat	
Per cent in sample	Per cent of total samples
Less than 8.00	4.9
8.00-8.24	24.9
8.25-8.49	47.2
8.50-8.74	17.0
8.75-9.00	4.2
More than 9.00	1.8
	100.0

Freezing Point		Per cent of total samples
Degrees C below zero		
Less than 0.510		5.1
0.510-0.519		3.1
0.520-0.529		12.4
0.530-0.539		57.8
0.540-0.550		17.5
More than 0.550		4.1
		100.0

The Public Health Department continued the preliminary survey, started late in 1971, into the nutritional quality of bottled milk, and over the period January-September, composite samples from treatment plants were analysed weekly for iron content.

Samples of bottled milk, from country and metropolitan treatment plants were also received in the course of regular monthly "screening" for organo-chlorine insecticide residues.

The Horticulture Division of the Department of Agriculture continued investigations into the residues of ethylene dibromide remaining in fruit juice following fumigation procedures. 47 samples, comprising lemon juice, mandarin juice and chiefly orange juice, from experimental treatments were received and analysed for ethylene dibromide.

20 samples of commercial orange juice were examined for compliance with the Food and Drug Regulations and in particular for juice content. To assist in evaluating the interpretation of these analyses, 14 orange juice concentrates (from which the commercial juice is prepared) were also submitted for examination. Where deficiencies were revealed the matter was dealt with by the Public Health Department, and in one case a successful prosecution was taken in respect of samples which failed to comply with the required standard of quality.

Varied samples of fruit juices were also submitted by the State Tender Board and examined for compliance with Food and Drug Regulations with a view to their use in Government institutions.

There was a marked increase in the number of fish and other sea foods received during the year. There was the normal small number of canned products examined for evidence of internal corrosion or putrefaction, and of fish in which artificial colouring was suspected. Approximately 100 samples, largely frozen fish and shell-fish, were analysed for evidence of incipient putrefaction, while nearly 300 samples of varied fish species and crustacea were submitted for determination of mercury content.

In addition to fish, analyses for mercury were also carried out on such varied samples as eggs, poultry feed, ox kidney, fish offal and sewage effluent.

Samples of fish and water were examined for pesticide residues to assist the Department of Fisheries and Fauna to evaluate possible hazards to marine life in areas of high pesticide usage.

Samples of peanuts were received for examination for residues of pesticides used during the growth of the crop, and others for analysis for aflatoxin B1, in respect of which a potential importer had specified a maximum of 0.01 part per million.

There was an increase in the number of liquors submitted by Public Health Inspectors for determination of spirit strength. These comprised 23 of brandy, 19 of rum, 17 of whisky, 3 of Ouzo and one each of gin and vodka. Approximately three-quarters of the samples failed to comply with the requirements of the Food and Drug Regulations for spirit strength, but it is emphasised that these were Inspectors' samples for which there was *prima facie* evidence of non-compliance with the legal standard. In a case of suspected adulteration of brandy with sherry, the analytical evidence, and comparison with an authentic sample of the brandy, confirmed that such was the case, but it was not possible to establish that the adulterant was the particular brand of sherry suspected of having been added.

42 samples of food were analysed for Vitamin C in connection with diet investigations conducted at a hospital. The majority of these were foods, prepared by different methods, which were submitted in order to ascertain the effect of the method of preparation on the Vitamin C content.

Another 42 samples of food were examined for arsenic, with negative result, in the course of a C.I.B. enquiry into a case of recurring illness.

Samples of eggs were analysed for fat and cholesterol concentrations in the yolks, while the fat was further examined to identify the type and amount of fatty acid present, in order to assess claims for high polyunsaturated fat content.

Samples of bread and milk bread submitted by the Department of Labour were analysed for compliance with the Bread Act Regulations, while other samples from the Public Health Department were examined to identify foreign matter visible in the bread.

The Division co-operated with other State Food Laboratories in a collaborative trial of the "orotic acid" method for the determination of non-fat milk solids in milk bread. Six commercial milk loaves, four "prepared" samples of bread containing known amounts of added skim milk powder, and a sample of the skim milk powder itself were examined in the course of the exercise.

A variety of food samples were submitted by the Departments of Agriculture and Public Health and examined for traces of pesticide residues. These included milk (from specific dairy farms), water, beef fat, potatoes, cabbage, celery, apples, peas, brussel sprouts, grapefruit and wine.

Miscellaneous food samples included samples of cake, cordial, dairy products and meat alleged to have caused illness; samples of tripe examined "for

pH and formaldehyde"; vegetables for identification of "foreign" powder; chocolate, tea and grain from consignments suspected of having been contaminated during transport.

Human Toxicology

Exhibits were received from approximately 480 cases of sudden death which were the subject of police investigation. Of this number, 191 cases, comprising 919 exhibits were submitted for examination for poisons or physiologically active drugs.

In 89 cases no poison or drug was detected, but in 102 cases at least one poisonous substance or drug was identified as a result of examination. In a number of cases the concentration of the drug made its toxicological significance uncertain.

Details are listed in Table 13.

TABLE 13.

Poison or Drug	No. of Cases
Carbon monoxide	36
Amylobarbitone	15
Pentobarbitone	13
Amitriptyline	6
Dibenzepin	4
Nortriptyline	4
Butobarbitone	3
Chlorpromazine	3
Phenobarbitone	3
Quinalbarbitone	3
Thioridazine	3
Butabarbitone	2
Carbromal	2
Cyanide	2
Desipramine	2
Diazepam	2
Methaqualone	2
*Various (one of each)	20
Negative	89

*Arsenic, chlordiazepoxide, dextropropoxyphene, dieldrin, digoxin, ethchlorvynol, formalin, imipramine, maldison, morphine, nitrazepam, paracetamol, perphenazine, phenacetin, phenytoin, propranolol, protriptyline, salicylic acid, strychnine, toluene.

In 76 of the 161 cases where a sample of blood was available alcohol was detected on analysis. The distribution of the blood-alcohol figures is shown in Table 14.

TABLE 14.

Alcohol, per cent	No. of cases
Negative	85
Less than 0.080	36
0.080-0.149	15
0.150-0.200	11
0.201-0.250	5
More than 0.250	9

Blood Alcohol (Traffic Deaths)

Three hundred and seventy nine samples of blood and/or urine were received from the Police Department in connection with investigations into fatal traffic accidents. Two hundred and seventeen of these were "post mortem" blood samples which were analysed for alcohol as a routine procedure.

The distribution of the analytical blood-alcohol figures for the various categories of persons involved in these accidents is shown in Table 15.

TABLE 15.

TRAFFIC ACCIDENT DEATHS

Alcohol, per cent	Drivers	Passengers No. Involved	Pedestrians
Negative	53	22	18
0-0.050 and less	6	5	3
0-0.051-0-0.079	2	2	1
0-0.080-0-0.099	5	4	1
0-0.100-0-0.149	20	4	7
0-0.150-0-0.200	21	4	4
0-0.201-0-0.250	14	3	4
0-0.251-0-0.300	1	4	3
More than 0.300	1	1	5
	123	49	45

Table 15 shows that 32 per cent of fatally injured drivers had a blood alcohol figure of, or exceeding, 0.150 per cent, while the corresponding figure for passengers and pedestrians was 24.5 per cent and 36 per cent respectively.

If the "upper limit" were 0.08 per cent, then Table 15 shows that 50 per cent of drivers had a blood alcohol figure of, or exceeding, this limit.

In presenting these figures it is emphasised that they apply only to the 217 samples of blood received from the Police Department for analysis; it is understood that the actual number of "traffic deaths" in Western Australia during 1972 totalled 349.

Blood Alcohol (Traffic Act)

Of the 658 samples the blood received for analysis under the classification of "Sobriety", 656 were submitted by Police and Local Traffic authorities in connection with—

- (a) charges of driving under the influence of alcohol;
- (b) other provisions of the Traffic Act.

Samples classified under (a) were those required by the police or traffic inspector, or taken from persons who on being charged with this offence, had exercised their right as provided by the Traffic Act to have a blood sample taken by a doctor and submitted for chemical analysis.

Samples classified under (b) were those taken from persons involved in a traffic accident which resulted in personal injury or damage to property, and where there were grounds for suspecting that alcohol was a factor contributing to the accident. In some cases "breath analysis" equipment was not readily available, or could not be used; in others the sample was requested by the subject exercising his rights following a "preliminary test" or a breath analysis, as provided for in the Traffic Act.

Under Section 32AA (1) of the Traffic Act it is an offence to drive a motor vehicle on a road or public place if the blood-alcohol concentration of the driver is 0.08 per cent or more. Under Section 32C (4), a blood-alcohol concentration of 0.15 per cent or more "is conclusive evidence that the person was, at that time, under the influence of alcohol to such an extent as to be incapable of having proper control of a vehicle . . ."

The results of analysis of samples taken under the provisions of the Traffic Act are set out in Table 16, the figure being the alcohol content of the blood at the time of the accident or alleged offence, calculated as prescribed by the Blood Sampling and Analysis Regulations, 1966.

TABLE 16

Alcohol, per cent	No. of Cases
0.050 and less	16
0.051-0.079	20
0.080-0.099	35
0.100-0.149	123
0.150-0.200	174
0.201-0.250	163
0.251-0.300	93
More than 0.300	32
	656

In accordance with established practice, each analysis was repeated independently by another chemist, making a total of 1,312 analyses in connection with this work.

Table 16 shows that 462 persons, or 70 per cent of the total, had a blood-alcohol figure of, or exceeding 0.150 per cent; 585 persons, or 89 per cent of the total, had a blood-alcohol figure of, or exceeding 0.100 per cent; and 620 persons, or 94.5 per cent of the total, had a blood alcohol figure of or exceeding 0.080 per cent.

Specimens from Patients

One hundred and forty-six samples were received under this classification. These were chiefly samples of urine and whole blood, with smaller numbers of serum, hair, nails, etc.

These were analysed in connection with the medical examination of patients for clinical purposes as distinct from industrial hygiene and toxicology. The different types of analyses performed under this classification are detailed in Table 17.

TABLE 17.

Analysis	Number
Arsenic	81
Lead	24
Amphetamines	15
Strontium	11
Cadmium	9
Thallium	9
Mercury	6
Copper	2
Morphine	2
*Various (one of each)	4
*Cannabis, chlordiazepoxide, drugs (general), zinc.	

Animal Toxicology

Thirty one exhibits were received from 17 animal post mortem examinations. Twelve cases were negative, while strychnine was detected in the other five. Of thirteen suspected poison baits submitted for examination, eleven were negative, cyanide was detected in one bait, strychnine and brucine in the other.

Industrial Hygiene

Two hundred and eighty-one samples were received during the year in connection with industrial hygiene investigations.

One hundred and eighty-four of these were specimens of urine from workers in occupations where a potential lead hazard was suspected. Analysis for lead was carried out to assist clinical diagnosis or to provide a "screening" to exclude the possibility of undue exposure.

Of these specimens 78 per cent contained not more than 0.08 part per million (milligram per litre) of lead (as Pb), 14 per cent contained 0.09-0.15 part per million, 4 per cent contained 0.16-0.20 part per million, and 4 per cent contained more than 0.20 part per million.

Other specimens of urine and blood were examined variously for arsenic, cadmium, mercury, cyanide and fluorine in connection with possible exposure of workers to hazardous conditions.

Inspections were made of working conditions in several factories and various samples were analysed for—

- (1) T.D.I. in plants where "foam" plastic was being made, or spray painting was in operation;
- (2) zinc in the air around welding operators;
- (3) sodium fluoroacetate levels during the manufacture of poisoned oats;
- (4) lead in a plastics factory where lead stearate was used.

Inspections were carried out as required to check working conditions during the unloading of cargo from ships' holds. These occurred as a result of spillage or leakage from containers of the chemicals dimethylamine, ferrosilicon, formalin, cresylic acid and "chlorinated hydrocarbon".

"On the spot" assessments of the degree of hazard were made by the inspecting chemist in each case, and advice given on ventilation and other measures necessary for safe working conditions.

Miscellaneous examinations included:

Analysis of the atmosphere of a botanical plant preservation room to exclude the possibility of hazard from dried mercuric chloride powder;

- a "contact" adhesive in which the solvents were identified as toluene and ethyl acetate, benzene being absent;
- testing of a portable unit alleged to produce ozone;
- examination of a baby's novelty teething ring for harmful components;
- identification of fine powder "contaminating" food premises following treatment for pest control.

Miscellaneous

Maritime Pollution.—There was a marked increase in the number of samples received in connection with maritime pollution, and the problem of identifying the offending source. 45 samples of oil were examined. These included not only the discharge from ships into harbour waters, submitted to establish that they were in fact oil, but in some cases, a number of samples from possible offenders, which were also submitted in an attempt to identify the origin of the discharge.

Pesticides.—There was only a slight increase in the number of pesticides as such received for analysis, 87 samples as compared with 75 in 1975. Types of pesticide are listed in Table 18.

TABLE 18.

Type of pesticide	No. of samples
Aldrin (concentrate)	6
Aldrin (diluted emulsion)	21
Diazinon (concentrate)	1
Dieldrin (concentrate)	5
Dieldrin (solid)	2
D.D.T. (concentrate)	1
Diquat (concentrate)	1
Fenitrothion (concentrate)	4
Heptachlor (concentrate)	3
Maldison (concentrate) ..	4
Monocrotophos (concentrate)	4
Weedicide concentrates—	
2,4-D amine	13
2,4-D ester	15
2,4,5-T ester	2
Various	5

Samples of aldrin concentrate and diluted emulsion were analysed for the Architectural Division, Public Works Department, as a check on the quality of materials used in "white ant" preventive treatments in building projects.

Samples of dieldrin concentrate, technical dieldrin, and concentrates of diazinon, heptachlor, monocrotophos and D.D.T. were assayed for the Biological Services Division of the Department of Agriculture; weedicide concentrates were analysed as a measure of quality control for the Weed Control Branch, while samples of fenitrothion and maldison concentrates were checked for use in programmes of grasshopper, locust and fruit fly control.

Criminal.—One hundred and sixty-eight exhibits were examined for the Police Department in connection with investigations by the Criminal Investigation Branch. These included 65 exhibits taken from 20 cases of suspected arson. In 28 exhibits from 14 cases a flammable material was detected. 18 exhibits contained kerosene, 2 contained petrol, and 2 a mixture of kerosene and light fuel oil.

Four exhibits concerned complaints alleging malicious damage to property, 11 were connected with assault, 23 with breaking and entering, 5 with stealing with violence 12 with home-made bombs and/or explosives, while there were 6 miscellaneous exhibits.

Drugs.—89 varied exhibits were received from the Police Drug Squad in connection with suspected possession of drugs. Exhibits included syringes, pipes (smoking), cigarettes and butts, tablets, capsules, powders and cardboard or paper (eg., "microdots"). In 40 exhibits where a drug was identified there were 15 of cannabis, 9 of opium, 8 of L.S.D. and 10 miscellaneous prohibited drugs. Most of the opium exhibits were from

the one group of persons. Of several samples of urine collected from suspects, butabarbitalone and methaqualone only were detected.

General.—One hundred and six samples of detergents were submitted by the Government Tender Board for consideration and advice on their suitability for use in Government Institutions. The samples varied considerably in type and the use for which they were intended, and comprised synthetic detergent mixtures, composite soap powders, laundry adjuncts, liquid soap type detergents, steam-cleaning compounds, solvent type degreasers and preparations for specialised uses.

Routine examination of samples was continued for the Western Australian Trotting Association, and 191 samples of horse urine and 18 of saliva were examined for drugs. Following several "positive" cases in which caffeine, theobromine and theophylline were detected, a number of preparations were also examined in attempts to ascertain the source of the positive result. In a Departmental experiment samples of urine were collected from a horse which had been fed a known quantity of kola-nut. Determination of drug levels in subsequent urine samples provided useful background information for the analysts engaged on this work. Traces of polyethylene glycol(s) were detected in several samples, and in another the presence of strychnine was indicated.

There was a marked decrease in the number of samples analysed for pesticide residues, as this section of the Division's work was badly interrupted by the fire early in the year. The analysis was completed of approximately 450 samples during the year. This figure includes 150 of the 200 not completed in 1971 and which either escaped fire damage or could be replaced. Of the 800 additional samples submitted in 1972, the greatest proportion were received from the Department of Agriculture and comprised samples of pasture, stock food, grain, milk, water, vegetables, soil and animal tissues. The latter were chiefly fat samples from animals grazing under varying conditions of possible exposure to organo-chlorine insecticides, and were submitted with samples of the pasture on which the animals had fed, in order to ascertain whether there was any correlation in pesticide levels.

Samples of water were examined as a check on possible contamination of drinking water supplies by insecticide "sprays", and a survey was started by the Department of Fisheries and Fauna to monitor the levels of pesticides in waters associated with marine life. Analysis of a small number of samples was also carried out for this Department to provide data on pesticide levels in wildlife, but the work required on a wide range of samples had to be deferred until 1973.

A range of miscellaneous samples was received and examined during the year:

Samples of fresh and used pharmaceutical cream were analysed for a hospital as a check on sodium absorption by the skin of the patient.

A sample of "normal saline" solution used for medical purposes contained suspended material which was identified as amorphous silica. It was considered that the glass of the bottle contained a slight residual alkalinity and that the silica suspension was produced following autoclaving.

Samples of Christmas crackers and of pistol "starting caps" were examined as a check on composition and for the presence of prohibited constituents.

Two portable fire extinguishers examined for carbon tetrachloride, were found to contain bromochloromethane and fluorotrichloromethane respectively.

Eleven samples of liquid mineral hydrocarbon for food use were submitted by the Food and Nutrition Officer of the Public Health Department and examined for compliance with the British Food and Drug Regulations for Mineral Hydrocarbons in Food. The examination included tests

for colour, taste, transparency, ultra-violet absorbance, acidity, alkalinity, carbonisable substances, solid paraffins and sulphur compounds. Five samples complied with all the standards prescribed by the Regulation.

Twenty four samples of imported crockery were examined for "extractable lead" in the ceramic glaze as part of a survey which was started by the Public Health Department late in the year. Only one item, a floral saucer, failed to meet the required standard, but it was shown that after the initial extraction the content of "extractable lead" was reduced to an acceptably low level.

A sample of home-made melon and lemon jam, which was free from any visible foreign matter, and had an agreeable lemon odour, nevertheless had a very bitter flavour. There was no evidence of the presence of alkaloids, and the level of copper was too low to account for the bitterness. It was considered probable that the flavour was due to the use of a wild melon which is often confused with the "piemelon" suitable for making jam.

The pie melon is elongated or oval in shape while the wild melon is spherical and usually characterised by green and white markings on the skin. While not all spherical melons belong to the variety containing the intense bitter principle, the safe rule seems to be to use only those which are elongated or oval in shape.

The normal enquiries for technical information and advice were received during the year, and expert evidence was tendered as required by officers of the Division in connection with their official duties.

General

Mr. R. C. Double was seconded to the Explosives Branch, Mines Department in January 1972 for a period of four months, to enable the Chief Inspector of Explosives to proceed on Long Service Leave.

Mr. N. T. Campbell attended the Conference of Scientific Officers engaged in Industrial Hygiene, held at Melbourne in February.

Mr. G. F. Ebell attended the Conference of Residue Chemists held at Lismore, N.S.W. in May.

Mr. B. F. Lynch attended the Conference of State Toxicologists, held at Brisbane in September.

Mr. N. R. Houghton attended the meeting of the Food Analysis (Reference) Sub-committee of the National Health and Medical Research Council, held at Sydney in November.

During his Long Service leave in September and October, Mr. V. J. McLinden received official assistance to attend the Sixth International Meeting of Forensic Sciences, held at Edinburgh in September. Whilst in the United Kingdom, Mr. McLinden visited a number of Laboratories including the Office of the Government Chemist, London, the Metropolitan Police Laboratories, London, the Equine Research Laboratory, Newmarket, and the Home Office Central Research Establishment, Aldermaston.

Mr. McLinden also participated in a Seminar held at Muresk in August on the Use and Abuse of Drugs in Horses organised by the Western Australia Institute of Technology in conjunction with the Western Australian Trotting Association and the Western Australian Turf Club. Mr. McLinden presented a paper on "The Analyst's Role in Swabbing the Horse".

Mr. F. E. Uren assisted at the Police Training School, and gave two series each of four lectures on "How the Research Chemist Can Assist in the Detection of Crime".

While on Annual Leave several members of the Division travelled overseas and took the opportunity to visit "kindred" Laboratories.

Mr. B. F. Lynch visited the Metropolitan Police Laboratories, London, the Home Counties Forensic Science Laboratory, Aldermaston and the Home Office Central Research Establishment, Aldermaston.

Mr. K. R. Price visited the Equine Research Laboratory, Newmarket, and received official assistance to spend two weeks at the Metropolitan Police Laboratories, London.

Mr. G. A. Taylor visited the Laboratory of the Government Chemist, London, the Home Counties Forensic Science Laboratory, Aldermaston, the Home Office Central Research Establishment, Aldermaston, and the Legal Laboratories of the Dutch Ministry of Justice, The Hague, Netherlands.

Messrs. McLinden, Lynch and Price have been active in the affairs of the recently formed Forensic Science Society of Western Australia and currently hold the positions of Secretary, Treasurer and Committee member respectively.

INDUSTRIAL CHEMISTRY DIVISION

Introduction

Two hundred and sixty-seven samples were examined during the year, a record number for this Division and 34 higher than the previous record in 1970. Seventeen samples were "Public Pay" and in addition 7 samples were paid for by other Government Departments.

The number of enquiries received continues to increase and, as usual, there has been considerable consultative work frequently involving short literature searches to obtain information for enquirers. Again, enquiries on plastics have constituted a considerable part of this consultative work.

Staff

- (1) Mr. A. P. Besselaar, Laboratory Technician, transferred to Food and Drug Division as a Chemist and Research Officer.
- (2) Mr. P. J. Ross was appointed Laboratory Technician.
- (3) Mr. R. I. McKinnon is now a Corporate Member of the Institution of Chemical Engineers. He also attended the Australian Chemical Engineering Conference at Newcastle, New South Wales, and visited eight establishments of similar work interest to our own in Sydney and Melbourne.
- (4) Dr. E. B. J. Smith again delivered the final lecture of the annual "Know Your Plastics" series organised by the Plastics Institute of Australia. Another lecture on aspects of plastics, as part of a short course organised by the P.I.A., was delivered to third year students in Architecture at the University of Western Australia.

Details of Work

1. Routine.

(a) Building materials.—A number of samples of building materials was examined during the year, particularly paints, and some further carpet testing has been carried out.

A description of the tests we have applied to carpets was given in the Annual Report for 1971. The tests are abrasion resistance, resistance to staining caused by a number of agents and ease of stain removal and resistance to colour fading. A further four samples of carpet were submitted to these tests.

Three of the samples tested in 1971 were then resubmitted for the examination of their dimensional stability under various simulated climatic conditions. The samples were of the needle-felted, resin-bonded synthetic fibre type. The samples were submitted to variations in temperature and humidity, the length of each side being measured under each set of conditions and after return to ambient conditions.

A further 4 samples of carpet were submitted to all the above tests. In the abrasion resistance test, weight losses after two hours ranged from 6.52 per cent to 14.3 per cent. In the staining test, as usual, biro ink, marking ink and shoe polish were the most difficult to remove although all 4 samples behaved reasonably well. In the U.V. exposure test, 3 of the 4 samples were severely

affected and the fourth only moderately. In the dimensional stability test, 3 of the 4 samples showed changes of less than 1 per cent, whilst the fourth showed a permanent shrinkage of about 1.5 per cent after the water soak.

We were also asked to examine the adhesive bonding of carpets to floors. In one case the adhesion of the needle-felted type of carpet to linoleum was tested because some problems had been experienced in practice. No evidence of surface irregularities such as blistering was found at the end of the tests.

In another series of tests we examined the adhesion of carpet, again the needle-felted type, to concrete, using concrete slabs for ease of handling. In this case we applied a peel strength test to give a quantitative comparison. Two brands of carpet were used and 4 different adhesives, 2 of which were solvent solution type and 2 were water-based. The adhesives were applied to the concrete slabs which were fixed to the floor. After open drying times of 10, 15, 20 and 60 minutes of the adhesive on the slab, a standard sized piece of carpet was placed on the adhesive and rolled for one minute.

Two types of failure were noted in the peel test.

Sudden failure: the carpet sample peeled off the concrete very rapidly.

Gradual failure: the carpet sample peeled off the concrete gradually over a period of a few minutes.

Two samples of carpet yarn were submitted for fibre identification. One sample was found to be 100 per cent wool and the other at least 70 per cent wool. Two samples of needle-felted synthetic carpet were solvent extracted to find out whether any oil was present. None was found and the only material identified was the binding resin.

Two samples of roof decking were submitted for accelerated testing under U.V. light. One sample was representative of a batch which had been installed on a house near the Kwinana industrial area. The original colour of the installed decking was olive-green, but was now yellowish-brown. It had been suggested that the colour change had been caused by air pollution. After 350 hours in the U.V. weatherometer the slight brown tinge of the first sample had become more intense, whilst the second sample had not changed colour but had started to chalk. The results thus indicated that the colour change on the original roof had been caused by natural weathering and not by air pollution.

In the South Hedland Primary School then being built, part of the exterior treatment was the erection of vertical panels of expanded metal, partly as decoration and partly as sunscreens which would still allow wind movement. The metal grids were protected by nylon applied by powder dip coating, but were incorrectly oversprayed with a gloss polyurethane coating. The Architectural Division asked us to suggest a suitable method for removal of the urethane coating. Our recommendation included a description of the hazards involved in using the solvents suggested together with the precautions to be taken.

A sample of asbestos cement coated with a particular brand of paint was submitted for testing the resistance of the coating to acid conditions as a guide to its use as a laboratory wall paint. It was considered that the paint would be suitable for laboratory walls where acids are being used.

A large number of paint samples has been tested during the year, mostly for the Government Tender Board. The testing of the 35 samples received late in 1971 was completed and reported and the Government Tender Board then supplied a further 35 samples purchased from retail stores as top quality shelf lines. These samples should match the first 35 samples as supplied direct by the paint manufacturers. It was, in fact, found that the second lot of samples matched the first lot reasonably well. As was to be expected, however, there were variations in particular properties.

Later in the year a further 15 samples of paint were submitted. These were random samples of paints in stock in Government Stores and were supplied as a further check on paint quality. These samples were generally found to match the approved samples quite well, although there were again some variations.

The final lot of samples from the Government Tender Board involved the examination of 62 samples submitted for the 1973 paint tender. Work on these is virtually complete.

Some other paint samples were examined. Six samples were submitted by Public Works Department and supplied by a small manufacturer. We had tested these paints in 1971 and they were found to be of poor quality. The present samples were much improved but there is room for further improvement.

The Public Health Department submitted a sample of a two-pot polyurethane paint for determination of isocyanate content both in the hardener and in the mixed paint and in the air above the mixed paint. The values found for isocyanate in the air ranged from about 11 p.p.m. down to about 2 p.p.m. The threshold safety limit for the particular isocyanate is 0.08 p.p.m. It is therefore clear that some care should be exercised in using such paints under factory conditions. Adequate ventilation must be provided.

The Main Roads Department submitted samples of the two components of a zinc rich paint late in 1971. The work was completed and reported in 1972. The liquid component was found to be an aqueous solution of potassium silicate and the zinc dust contained 99 per cent zinc. The slip factor was also determined.

The Public Health Department submitted two panes of glass which had been left exposed in the car park of a Government establishment. Employees had complained of paint spotting of their cars and a nearby paint spraying shop was suspect. We have been asked to examine the paint spots on the glass plates and, if possible, identify the type of paint. This work is still in progress and will be reported next year.

(b) Plastics.—In 1971 we reported the results of some tests on plastic concrete underlay. These tests were water absorption, water vapour transmission, falling weight impact test and resistance to hydrostatic pressure. This year we reported the results of tests carried out on 24 samples of various types of concrete underlay, mostly plastic. It has not yet been possible to carry out the water vapour transmission test because of fire damage to the constant temperature and humidity room needed. Most samples passed all three tests quite satisfactorily, although there were three failures in the hydrostatic pressure test.

Four samples of rigid PVC pipe were submitted by Public Works Department for determination of opacity. The test was carried out using a suitable spectrometer and all samples were found to have a light transmission factor of less than 0.05 per cent.

A sample of window flashing made from polypropylene by extrusion was submitted by Public Works Department. This product is to be made by a local manufacturer and we were asked to test the material in various ways. We considered no testing was necessary since the physical and chemical properties of this plastic were more than adequate for the proposed use. With the proviso that the polypropylene be formulated with an adequate amount of carbon black pigment for protection against ultraviolet light degradation, we suggested that the application be approved.

The Harbour and Lights Department are particularly interested in the use of glass reinforced plastics in boat construction, especially commercial boats such as fishing trawlers. They are also interested such as fishing trawlers. They are also interested and for insulation of brine tanks, etc. They have submitted several samples in 1972 for examination and testing.

The first samples received were three pieces of glass reinforced plastic cut from boats being made by three different manufacturers. We were asked to determine the glass/resin ratio and ounces of glass per square foot for each sample.

The next samples received were two pieces of polyurethane foam made by a manufacturer interested in supplying it for buoyancy purposes. We were asked to test the samples for stability under temperature cycling between 10°F and 150°F, resistance to kerosine and to a petroleum fraction of high aromatic content, and water absorption. The tests are interdependent since some samples go through all tests.

A new type of polyurethane foam is becoming available locally. This is called isocyanurate foam, whilst the regular material could be called isocyanate foam. The new type is claimed to be much more fire retardant than the regular foam and the Harbour and Lights Department submitted samples of both types for this property to be checked. The samples were tested as closely as possible to ASTM D1692-68 and the isocyanurate foam was found to be substantially more fire resistant.

Both foams were self-extinguishing by the test, the flame being extinguished before the end of the 60 second application time of the burner.

The Main Roads Department submitted a sample of plastic lumps collected near the site of a road surface failure in Canning Highway. We were requested to recommend a suitable solvent to dissolve the material. The lumps were found to be a mixture of polyvinylacetate and another vinyl resin not identified. No readily available solvent could be suggested since the unidentified component was not readily soluble.

The Public Works Department submitted three samples of laminated plastic sheet with a satin finish which were under consideration as desk tops in schools, to minimise glare. We were asked to determine light reflection, resistance to staining and ease of removal of stains, possible application of trade preparations to minimise staining, resistance to abrasion, impact resistance, heat resistance, acid resistance and thickness of surface material. Two of the three samples had a satin finish produced during the pressing process, whilst the third had its satin finish produced by rubbing down the original gloss with a fine abrasive. All three samples showed a grain effect running in one direction across the sheet.

A sample of clear plastic pipe was submitted by Public Works Department. It had been installed as a flowmeter on a tank handling 5 per cent caustic soda solution in a water treatment plant in a country town and had cracked within a day or two of use. The material was identified as polycarbonate and it was noted that there was some etching of the inside surface. A paper measuring scale had also been bonded to the outside of the pipe by means of a solvent-type rubber adhesive. After cracking, the pipe had curled in on itself, indicating that it had been under stress. It was suggested that the failure was an example of environmental stress cracking possibly caused by the solvent in the adhesive. It was pointed out that solutions of caustic soda can attack polycarbonate and we subsequently received advice from a German manufacturer of the material that the plastic can only be used in caustic soda solutions of less than 3 per cent strength at room temperature.

(c) Miscellaneous.—Six samples of lignosulphonic acid concrete additive were submitted by Main Roads Department. They were analysed for lignosulphonic acid and sugar content and were found to be satisfactory.

Two samples of galvanised steel were submitted for measurement of the thickness of the zinc coating. This was done by a non-destructive, magnetic method.

The Public Health Department submitted a sample of a material used in the compounding of rigid PVC compositions. They requested an analysis for lead stearate content. It was, in fact, found that the material was dibasic lead stearate.

Lupinosis is a disease which afflicts sheep grazing on dry lupins in some areas during the summer months. The Department of Agriculture has been working on this problem for some time and it is now thought that the toxic principle might be produced by a fungus growing on the lupins. We were asked by the Department to extract about 12 kilograms of dry lupins with cold methanol. Several extractions were carried out and in each case the methanol extracts were concentrated to small bulk under reduced pressure. The concentrates were collected by the Department of Agriculture who will work them up to find how much toxic material is present. Their intention is to isolate the toxic principle and determine its chemical structure.

A total of 42 samples of lignite were received in mid December from the Geological Survey, having been taken from the Fitzgerald River deposit. We have been asked to determine montan wax content and some properties of the wax. This work is in progress and will be reported next year.

2. Assistance to Industry

(a) Glass windows.—In a large city building finished during the year it was discovered that the glass in many windows was covered with a whitish deposit only visible in certain lighting, but rather disfiguring. The builders were unable to remove it and we were asked for assistance. It was not possible to identify the material in the very small sample of scrapings provided, so a complete window was supplied. After trying a number of solvents, acids and other chemical cleaning solutions, without success, we were finally able to remove the deposit by wet buffing with an abrasive paste.

(b) Window frames.—In another city building still under construction a problem was also experienced with the windows, this time with the painting of the surrounds. In this case each window unit was an integral part of the outer wall of the building. The units consisted of an outer asbestos cement shaping back-filled with reinforced concrete, the two parts being bonded together by applying two coats of epoxy adhesive to the back of asbestos cement before the concrete was poured. After curing and drying the units were removed to the paint shop where an epoxy sealer was applied to the front of the asbestos cement followed by several polyurethane paint undercoats. The surface was then carefully wet sanded and after drying the full gloss, polyurethane top coat applied. No trouble was experienced during the summer and autumn, but during the cold, wet winter months it was found that many window units had developed small blistered areas very close to the edge of the painted area. Heaters had been installed in both curing shop and paint shop in an attempt to overcome the problem of low temperatures and high humidities or free water as rain or during sanding, but without complete success. The trouble was certainly caused by water and our recommendation was to seal not only the face of the asbestos cement, but also the sides and to do this in the casting shop before transfer to the paint shop. Blistered areas on windows already painted will be made good on site.

(c) Polyester resins.—As mentioned in our last report, a sample of polyester resin of local manufacture was submitted for testing. Subsequently we received 5 further samples. All were tested as far as we were able and found to be generally satisfactory. In particular, the last sample, a fire retardant grade, was found to have a flammability rating according to BS 3532 1962 of "very low flammability". This is equivalent to "non-burning" according to ASTM D635.

(d) Peat wax.—Three samples of peat were analysed for wax content.

(e) Montan wax.—Three large samples of lignite from South Australia were extracted in our pilot plant. The 3 batches of wax produced were returned to the Company concerned and we subsequently received a sample from each of the three batches of wax for determination of some properties.

(f) Theatre screen.—The owners of a drive-in theatre asked us to identify a discolouration on their screen which was showing up as dark markings during the screening of films. The screen had been fabricated from asbestos cement sheet, apparently the first time this material had been used for such a purpose in Perth. Samples were cut out from the screen and supplied for our examination. It was quickly found that the main cause of discolouration was mould growth which can be readily removed by washing down with dilute sodium hypochlorite solution. Also present were metallic stains easily removed by treatment with dilute hydrochloric acid. These stains were probably of no importance and may have been caused during the cutting out operation. After original erection, the screen had been painted with a special flat paint and a coat of sealing paint should have been applied first. There was some suspicion that this sealing coat had not in fact been used.

(g) Lemon grass oil.—A farmer at Kununurra is interested in producing lemon grass oil and possibly other essential oils. Several samples of lemon grass were submitted to recover the oil by steam distillation and the oil then passed over to the Food and Drug Division for a citral assay.

(h) Concreté additive.—A concrete manufacturer submitted two samples of concrete for determination of lignosulphonic acid content.

(i) Binder twine.—An agent importing polypropylene binder twine asked us to investigate the effect of ultraviolet light on the strength of several grades of twine. Some of one particular shipment and used for baling hay had failed after exposure to the sun for about 70 days. Four samples were supplied, one from the farm, another of the same batch ex store, and two other grades. As expected all four samples were weakened by exposure to ultraviolet light, but one in particular somewhat more than the others, but this was not the one that had failed.

3. Investigational

(a) Painting of Karri Timber.—This investigation is proceeding and after two inspections there is still no sign of any failures on most of the panels. However, on three panels, which, at the suggestion of the paint manufacturer, were not primed, the paint has started to crack along the edges of the panels. On two other panels, from two different paint systems, signs of checking are showing up.

(b) Printers' Rollers.—Work continues slowly on this investigation and we have again been seriously delayed by slow delivery of ingredients.

The polysulphide rubber roller described in our last report was repaired but unfortunately the newly cast section was found to have too many small bubbles after the surface was ground off by the Government Printer. This was a disappointment but the operation at least showed that repairs of this kind can be carried out. The newly cast section bonded very well to the old and after grinding no joint could be seen. Near the end of the year we finally obtained the last ingredients required to formulate our own polysulphide rubber blends and we hope to carry out further experiments with these materials in the coming year.

One of the small PVC rollers broke down by failure of the bond between the PVC and the epoxy primed metal stock. We have been investigating ways of improving this bond strength. Addition of some epoxy resin to the PVC plastisol does this and it should only be necessary to use a relatively thin layer of this blend, the rest of the roller being unmodified PVC. We have also contacted another raw materials supplier who not only replied promptly with much advice and a number of formulations, but also despatched all the samples of

their manufacture very quickly. All this did not occur till December and we have still to obtain some ingredients from other manufacturers. We should have an interesting time in 1973.

(c) Polyester Drafting Film.—A considerable amount of work has been done on this project and a large number of formulations for the coating solution has been tested. Some of the formulations gave moderately satisfactory results, but in general not good enough in comparison with commercially available materials. The coatings were usually inferior in hardness, ink receptivity and ability to erase both pencil and ink without leaving a 'ghost' mark on the coating. However, we did produce one coating using a polyurethane resin which was reported on quite favourably. It was still not quite hard enough and it was also attacked by methylated spirits.

Most of the formulations we have examined have been based on solutions of resins in organic solvents. It would be preferable to use a water-based system, but the few resin emulsions we have tested so far have given inferior results. We have again been plagued with long delays in obtaining samples from some manufacturers, in particular the curable or self-crosslinking type of acrylic emulsion which is likely to give better results. We hope this situation will be resolved in the coming year.

(d) Rust Treatment.—We have obtained a number of the raw materials required for this Departmental project and in addition have purchased a salt spray testing cabinet in which the initial testing of the various panels can be carried out. Work has started, but it is too early yet for results to be reported.

(e) Potassium and Magnesium Salts.—The literature survey and report has now been completed and a further discussion was held with the initiator of the enquiry. However, we have not been asked to carry out any experimental work as yet.

(f) Rheology of Paints.—This report has not been completed since we had hoped that a local paint manufacturer was going to purchase a cone and plate viscometer on which some experimental work might have been possible. However, this purchase did not eventuate, but we have collected literature from suppliers of these viscometers and the project may be resurrected at a later date.

(g) Clear Lacquers for Timber.—Timber with an attractive grain and colour shows up very well when coated with a clear lacquer. Indoors this works very well, but outdoors the clear film degrades very quickly. A clear alkyd finish will not last longer than 12 months at the most, whereas the same resin fully pigmented to produce an opaque paint will last 5 years or more without requiring repainting. The pigment acts as an absorber and reflector of ultraviolet light and slows down the rate of degradation of the paint film. If a pigment could be chosen which had the same refractive index as the paint it would become invisible but still capable of absorbing and reflecting ultraviolet light. A reference to work of this kind carried out in England by the Forest Products Research Laboratory was noted in the literature. They claimed that the use of such pigments did, in fact, produce the desired effect and such clear timber coatings degraded in the same way as pigmented coatings by chalking and slow erosion. The indications were that such paints might last as long as opaque paints. It was considered that the problem should be investigated in these Laboratories and the investigation has now been approved as a Departmental project. The types of material suggested as "invisible" pigments are ground glass, pumice powder, mica, ground blast furnace slag and fly ash. Work has started and most of the materials needed have been obtained. We have produced clear paints and initial indications are satisfactory.

(h) Wood Waste Utilisation.—Much work has been done in many parts of the world on the utilisation of wood wastes but without too much success although many possible processes have been evolved. Western Australia is certainly not unique in having a wood waste disposal problem. Much of this occurs in forest areas and cost of transport to some central processing factory would be too expensive. However, there are supplies of

sawdust and woodflour in the metropolitan area. One factory, for example has at least 200 tons per month of woodflour to dispose of. In addition, there is a variable amount of oat hulls available, up to about 7,000 tons per year. It was thought worthwhile to look at ways of utilising this waste and various possibilities will be tried. Initially, some work was done on conversion to activated charcoal and a reasonably satisfactory product was obtained. Late in the year a major chemical manufacturer, already importing activated charcoal, announced a plan to produce this material from Victorian brown coal. Therefore, our work in this area was stopped, at least for the time being. Other possible uses are now being investigated.

4. Other Activities

Scaevola spinescens.—We have continued to supply an extract of this plant to cancer sufferers, although numbers have been low for most of the year. Only one collecting trip was necessary. A second trip was made with the Government Botanist to locate new collecting areas. Good supplies were found in two areas north of Coolgardie-Kalgoorlie.

The results of the pharmacological work carried out at the University of Western Australia were published in *Pharmaceutical Research Communications*, Vol. 3, No. 3, 261, 1971. The extract was found to contain an antagonist of 5-hydroxy-tryptamine.

As a result of an overseas trip by Superintendent Athol Monck, we were contacted by the Wellcome Research Laboratories of England and Aktiebolaget Astra of Sweden. A long report was sent to each Company describing the situation and the results that appear to have been obtained here. In addition, a sample of spray-dried extract was sent to the Wellcome Research Laboratories. They subsequently advised that they had sent material to America for screening for anti-tumour activity and that they would test the material themselves for pharmacological activity in due course. No results have yet been reported to us.

5. Consultative

As usual we have had much consultative work. Enquiries are received from Government Departments both Commonwealth and State, private industry and individuals. A selection from enquiries received is given below.

- Utilisation of oat hulls;
- Production of essential oils;
- Production of urethane foam filled building panels;
- Plastic houses from several enquirers;
- Manufacture of U.F. adhesive and formaldehyde;
- Adhesion problems with ceramic tiles;
- Specification for glass reinforced plastics fascias for a large building;
- Manufacture of paints;
- Corrosion problems in transporting copper concentrate interstate and use of plastic liners;
- Local manufacture of fan blades in glass reinforced plastic.

KALGOORLIE METALLURGICAL LABORATORY

General

One hundred and ninety six certificates of testing or analysis were issued during the year.

Six C.S.I.R.O. reports were issued but most of the research work was carried out for Mining Companies who did not want their results to be made public and so confidential certificates were issued. (Reports 765-771).

During the year the laboratory carried out a considerable number of flotation tests on nickel ore from several mining Companies. The Companies concerned carried out the required assays in their own chemical laboratory and then returned

the results to us for the metallurgical calculations as we were short of staff and unable to complete the assays in a reasonable time.

Several other mining Companies availed themselves of our metallurgical experience to separate their products and return the samples to them for further evaluation and analysis.

Work required from the laboratory is now oriented towards gold due to the rise in its free market price, whereas last year our activities were directed to nickel. The source and type of samples received are shown in Table 19.

Staff

Staff appointments were made during the year in the following order:

Mr. R. McLellan was engaged as a laboratory Assistant 1/1/72.

Mr. J. Lewis was engaged as Assayer 6/6/72.

Mr. G. H. Muskett was appointed from an Acting position to Officer in Charge 26/6/72.

Mr. H. R. Dunstan was appointed from an Acting position to Research Metallurgist Grade I 29/10/72.

Mr. F. Steele was engaged as Senior Assayer 3/11/72.

Our enlarged staff will be able to handle the laboratory's work more readily to satisfy a widening circle of enquiries.

To date we have had a number of enquiries on how to treat tailing dumps but as the margin of profit is tied to the price of gold on the free market, companies are reluctant to spend money until more is known about the role gold will take in the world currency system.

Buildings

The outside of the laboratory was repainted and corroded down pipes were replaced. Floors and pieces of equipment were cleaned down and painted.

Equipment

A new Siebtechnik vibratory mill with a 250cc vessel was installed and gives us a unit more suited to grinding nickel ore than the standard Braun pulverizer.

A Sala wet magnetic separator was obtained for handling the magnetic fraction found in nickel ore such as pyrrhotite or magnetite.

A new Demineraliser was obtained to replace our old unit.

TABLE 19.

KALGOORLIE METALLURGICAL LABORATORY

Ore and Minerals	Mines Dept.	Native Welfare Dept.	Public Free	Pay	Total
Copper	48	50
Gold—					
Ore	21	2	4	977	1,004
Tails	186	186
Heavy Sands	75	75
Lead	32	32
Nickel	160	160
Platinum
Other	139	139
Various	56	56
Total	21	4	4	1,673	1,702

NOTE: In addition 707 nickel assays of Metallurgical products produced in our laboratory were assayed by the Company concerned and returned to us for Metallurgical calculations, as we had lost the services of our Senior Assayer who had resigned.

MINERAL DIVISION

General

The total number of samples received in the Division was almost double that of the previous year. Of the 4,534 samples concerned, 306 had been registered to other Divisions with supplementary work requested of Mineral Division. Most of this supplementary work involved the use of X-ray diffraction techniques for the identification of the clay fractions of soils.

In the various categories of work, marked increases occurred in clays, complete analyses, dusts, gold and vanadium. Complete analyses of rocks and minerals were carried out almost exclusively for the Geological Survey, increasing use being made of X-ray fluorescence methods for this purpose. Increase in dust samples followed the continuing activities of the Public Health Department in the fields of both atmospheric pollution and occupational health hazards. The current interest in locating clays of the high quality required by the paper industry contributed something towards the increased number of clay samples received though the major increase in this field lay in the determination of clay species for the Agriculture Department and the Geological Survey Branch.

The two-fold increase in samples for gold assay and the manyfold increase in vanadium samples from 17 in 1971 to 227 in 1972 were both due to research programmes concerning these two metals being undertaken at Engineering Chemistry Division.

The most marked decreases in sample numbers were in heavy sands and samples for nickel and titanium determination; also, only about half the number of samples were submitted by the public for mineral identification as were received in the previous year.

The source and types of samples handled during 1972 are listed in Table 20.

Staff

Mr. R. M. Clarke commenced duties as Mineralogist and Research Officer in May and Mrs. P. L. Godkin was appointed as Laboratory Technician in February.

Mr. F. G. O'Halloran, Laboratory Technician, commenced leave at the end of the year prior to retirement after 25 years of valued and conscientious service.

Mr. G. Payne attended a meeting in Adelaide of a Committee of the Standards Association of Australia dealing with the chemical analysis of

iron ore where particular attention was given to the determination by atomic absorption of calcium, magnesium, manganese and aluminium in a range of iron ores.

Mr. K. Renton read a paper on analytical techniques applied to certain aspects of air pollution at a symposium on "Environmental Assessment" arranged by the Royal Australian Chemical Institute. The same officer also attended a safety symposium held at W.A. Institute of Technology.

Mr. Payne addressed the staff of Geological Survey regarding facilities currently available in the Laboratories of value to the Survey and discussed the value of close liaison between the two Branches.

A seminar on "Non-flame Techniques for Atomic Absorption Spectroscopy" was attended by Mr. M. B. Costello. Mr. Costello also filled the position of Honorary Secretary of the W.A. Branch of the Royal Australian Chemical Institute and Mr. P. Hewson acted as Secretary of the Analytical Group within the Branch. Mr. D. Burns was a member of a committee convened to form a consultants panel within the Institute.

Publications

Two papers were published during the year. "Calcium sulphosilicate in lime-kiln wall coating" by M. Pryce described an unusual deposit encountered in material submitted for examination by Swan Portland Cement Ltd. and "Biphosphamite: a second occurrence" by the same author records and describes a natural occurrence of ammonium dihydrogen orthophosphate in material from a cave on the Nullabor Plain.

Laboratory Inspections

Two public laboratories which had applied to National Association of Testing Authorities for registration by that body were assessed by staff members at the request of N.A.T.A. Our own heat and temperature facilities were reassessed by N.A.T.A. in November.

Table 20
MINERAL DIVISION

	Main Roads Department	Mines Department (a)	Other Government Departments (b)	Police Department	Public			Public Health Department	Total
					Pay	Concession	Free		
Building materials (c)	36	8	32	16	92
Complete analyses	855	4	859
Dusts	4	1,043	1,047
Geochemistry	806	16	4	826
Mineral identifications	3	296	10	40	74	10	433
Miscellaneous	4	42	99	33	53	9	8	8	256
Ores and minerals—									
Clay	27	189	34	9	259
Copper	12	5	6	23
Gold ores	5	50	39	6	100
Gold tails (incl. umpires)	47	13	60
Gold investigational	89	89
Heavy sands	11	8	19
Lithium	1	10	11
Monazite	6	6
Nickel	5	28	9	42
Selenium	31	31
Titanium	3	10	13
Uranium	14	3	6	23
Vanadium	2	222	2	1	227
Various	8	1	9	16	34
Police exhibits	84	84
	43	2,135	331	117	650	182	24	1,052	4,534

(a) Includes Geological Survey, State Batteries, State Mining Engineer, Explosives and internal Divisional work.

(b) Includes Aboriginal Affairs, Agriculture, Community Welfare, Consumer Protection, Labour, Public Works, State Government Insurance Office, State Housing Commission, Tender Board, University of W.A. and Commonwealth Departments of Navy, P.M.G., Works.

(c) Includes concrete, cement, aggregates, bricks, building stone.

Equipment

The main wing of the Mineral Division suffered only minor damage from the fire that gutted much of the Laboratories in January.

However, the sample preparation room and fire assaying laboratory were both severely damaged. Jaw crackers, rolls and pulverizers were unserviceable for some months due mainly to damage to electrical fittings while the first gold assay since the fire could not be carried out until June. Temporary crushing facilities allowed of some sample preparation but a considerable build up of samples awaiting preparation was inevitable.

The main fire-caused equipment losses were a large sample drier, variac voltage control and L. & N. micro-max recorder, a 30 ton press and dies, standard sieves and three Mettler balances.

The major items of equipment purchased during the year were a Zeiss stereomicroscope and an MSE centrifuge.

Specifications have been drawn up and tenders called for the purchase of a diffractometer unit to operate from the existing Philips PW 1130 generator. This unit will meet the urgent need for quantitative determinations on dusts and mineral products generally.

Mineral Collections

The addition of 254 specimens during the year brought the number of samples in the Mineral Division reference collection to 4,995. Thirteen were from overseas, and ten from other Australian States, the remainder being from Western Australia.

The overseas additions were mainly of species so far not identified from Western Australia and included selenium crystals from New Mexico, volborthite from Arizona, rockbridgeite from Bavaria and a series of uranium minerals which included andersonite, coffinite, cuprosklodowskite, francevillite, tyuyamunite, sklodowskite and uranophane.

A fine suite of specimens from the Nabarlek uranium deposit in the Northern Territory was donated by Queensland Mines Ltd.

A considerable number of nickel minerals were added to the collection. These included a fine specimen of millerite and violarite from the Otter Shoot at Kambalda, pentlandite from Windarra and from the 600 ft level of a new shaft at Widgiemooltha, pentlandite and niccolite from Spargoville, violarite from Agnew and Scotia, "garnierite" from Carr Boyd, cubanite from Scotia and takovite from Carr Boyd, Widgiemooltha and Kambalda.

Other nickel-bearing minerals were nickeloan magnesite from Pyke Hill, Kambalda, Widgiemooltha, Scotia and Yundamindera, nickeloan dolomite from Scotia, nickeliferous malachite from Kambalda, Widgiemooltha, Scotia and Carr Boyd, nickeliferous magnetite from Nullagine, nickeliferous antigorite from Kambalda, nickeliferous nontronite from Scotia and Widgiemooltha and nickeliferous kaolin from Widgiemooltha.

Though no Mineral Division records were lost in the fire precautions have now been taken by duplicating all registers and card indexes dealing with the Simpson and Mineral Division mineral collections, and the Divisional polished mount and thin section collections. These duplicates will be stored away from the Laboratories.

New Mineral Localities

Localities from which specific minerals were recorded for the first time in these Laboratories during 1972 are listed below. An asterisk indicates species identified for the first time in Western Australia.

As information regarding localities is in many cases confidential only general localities are listed. Further details could be available on application depending on the source of the original sample.

(a) Kimberley Division

Beaverite	Narlarla
Cerussite	Carlton Hill Station
Chalcopyrite	Carlton Hill Station
Hemimorphite	Carlton Hill Station
Malachite	Carlton Hill Station
Smithsonite	Carlton Hill Station

(b) North West Division

*Bastnaesite	Edmund Station
Beudantite	Ashburton Downs
Bismutite	Tambourah
Carnotite	Yinnietharra
Chenevixite	Ashburton Downs
Chrysocolla	Mt. Blair
Clinochlore	Soanesville
Columbite	Yinnietharra
Columbite	Noreena Downs
Cuprite	Mt. Blair
Diopside	Yinnietharra
Duftite	Mundong Well
Gypsum	Bidgemia
Gypsum	Hill Springs
Hollandite	Yinnietharra
Idocrase	5 miles S of Roebourne
Kasolite	Telfer River
Lepidolite	Yinnietharra
Magnetitite	(nickeliferous) Nullagine
Malachite	Mt. Blair
*Meta-autunite	Nyang Station
Monazite	Edmund Station
Platnerite	Uaroo
Phosphouranylite	Nyang Station
Rubellite	Yinnietharra
Rutile, niobian	Yinnietharra
Talc	Yinnietharra
Tanteuxenite	Lalla Rookh
Variscite	Yinnietharra

(c) Murchison Division

Beryl	Errabiddy
Carnotite	Noondie
Diatomite	Howatharra
Gypsum	Nanga
Gypsum	Chunderloo
Molybdenite	18 miles E of Mt. Magnet
Montmorillonite	Howatharra
Psilomelane	Woodrarrung Range
Talc	5 miles S of Gullewa

(d) South West Division

Anthophyllite	Bridgetown
Ardealite	Cervantes
Ardealite	Eneabba
Beryl	Jacobs Well
Bityite	Rothsay
Brushite	Cervantes
Brushite	Eneabba
Columbite	Paynes Find
Dahlite	Cervantes
Gypsum	Eneabba
Gypsum	Cervantes
Talc	Bridgetown
*Tephroite	11 miles S of Donnybrook
Turquoise	Greenbushes
Vermiculite	Donnybrook
Weddellite	Watheroo

(e) Central Division

Atacamite	L. Cowan
Atacamite	Widgiemooltha
Azurite	Bulong
Azurite	Widgiemooltha
*Bassanite	Pyke Hollow
Bismoclite	Londonderry
Bloedite	Carr Boyd
Brochantite	L. Cowan
Carnotite	Yeelirrie
Chalcanthite	Murrin Murrin
Chalcocite	Paddington
Chalcopyrite	Paddington
Chalcopyrite	Widgiemooltha
Cubanite	Scotia
Diopside	Eucalyptus
Epsomite	Carr Boyd
Garnierite	Carr Boyd
Jarosite	L. Cowan

(e) Central Division—continued

Lithiophorite	Widgiemooltha
Malachite	L. Cowan
Malachite	Widgiemooltha
Malachite	Bulong
Nicolite	Spargoville
Nickel antigorite	Kambalda
Nickeloan magnesite	Widgiemooltha
Nickeloan malachite	Widgiemooltha
Nickeloan malachite	Carr Boyd
Opal (precious)	Karonie
Paratacamite	Widgiemooltha
Paratacamite	L. Cowan
Paratacamite	Carr Boyd
Paratacamite	Goongarrie
Pentlandite	Spargoville
Pentlandite	Windarra
Pickeringite	Eulamanna
Pickeringite	Murrin Murrin
Pickeringite	Bullfinch
Pyrrhotite	Spargoville
Pyrrhotite	Windarra
Takovite	Kambalda
Takovite	Widgiemooltha
Takovite	Carr Boyd
Talc	Hampton Plains
*Varlamoffite	Londonderry
Violarite	Agnew

(f) North East Division

Graphite	Mt. Connaughton
*Metavariscite	Ragged Hills

(g) East Division

Brochantite	Warburton Mission
*Djurleite	Warburton Mission
Muscovite	50 miles NE of Warburton Ranges

Complete Analyses

The first batch of complete rock analyses carried out by X-ray fluorescence techniques was reported in February. At the end of the year many such analyses had been reported, including 20 core samples from a dolerite sill in the Wiell Wollie Formation in the Hamersley Basin, 20 ultramafic lavas for Mt. Clifford and Yundamindera, 6 pillow lavas from Carlaminda and the Cooglegong area, 85 granites from the Cue sheet, 44 rocks from the Ravensthorpe area, 39 from the Murgoo sheet and 19 from the Yalgoo sheet.

Almost all complete analyses were carried out for the Geological Survey or for Departmental records.

However, a sample from a non-Government source was of particular interest. A solid core from considerable depth in the Agnew area was found to disintegrate to powder on exposure to atmosphere. Mr. J. Just of Australian Selection (Pty) Ltd. who first noticed this phenomenon and identified coalingite as the mineral mainly responsible, submitted a sample containing the end product of this breakdown.

Coalingite, believed to be an alteration product of brucite, has been recorded only twice before, from the Type locality of San Benito, California and from the Muskox Intrusion in the Canadian Northwest Territories. Recovery of the mineral in a pure form for analysis is extremely difficult and recorded analyses have been on material subjected to various forms of concentration, followed by hand picking of grains under the microscope.

The analysis of the original coalingite from California had been made on less than 500 mg, while only 110 mg of the Agnew material could be recovered for analysis. Even after handpicking, some adjustments have to be made on the final figures to allow for known impurities. Rationalised analyses of coalingite from the three recorded occurrences, expressed as percentages, are tabulated below:—

	California	Canada	W.A.
MgO	47.0	48.8
Fe ₂ O ₃	18.7	19.3
CO ₂	4.9	4.6
H ₂ O ⁺	29.4	27.3

Even allowing for analytical and sampling problems it is evident that molecular ratios of coalingite, particularly the Mg:CO₃ ratio, can vary widely, indicating it to be a non-stoichiometric compound of variable composition.

Complete analysis of a fresh bore core containing this reactive mineral gave the following results:

	Per cent.
SiO ₂ 34.73
Fe ₂ O ₃ 4.63
FeO 1.18
Al ₂ O ₃ 4.41
MgO 43.04
CaO 0.10
K ₂ O (a)
Na ₂ O (a)
MnO 0.08
TiO ₂ 0.01
P ₂ O ₅ 0.02
CO ₂ 0.81
S 0.12
H ₂ O ⁺ 13.32
H ₂ O ⁻ 0.89
NiO 0.60
CoO 0.01
Cr ₂ O ₃ 0.05
CuO (a)
	100.00
Less O ≡ S 0.06
	99.94

(a) less than 0.01

Analyst: R. S. Pepper

A paper has been accepted for early publication in The Mineralogical Magazine describing the unusual low-iron cordierite occurrence on Yinnetharra referred to in the Annual Report for 1970. Complete analyses have now been made of fresh cordierite from a more accurately described locality, and also of the phlogopite mica with which it is associated.

Special Analyses

A number of samples were submitted for chemical analyses by mineral producers and private laboratories to provide standards for their own use, on as checks against their own methods or to assist in finding reasons for differences in results on the same material among different laboratories.

In this field, a number of samples of gold ores and tailings that had previously been assayed by fire assay in the Division were supplied to private laboratories as standards for use in their atomic absorption techniques.

Analysis by classical means of a raw mix consisting of limestone, bauxite, sand and iron oxide was made for an industrial organisation for their use as a standard. Another analysis of the same type was the determination of sulphide sulphur in blast furnace slag. The use of this material as an admixture with cement lowers costs and is stated to give a concrete of equal or greater strength.

However, claims are made that the presence of sulphides in the slag can lead to corrosion of reinforcing and so an accurate determination of the sulphide sulphur in the slag is imperative. The method used was that recommended by the I.S.O. in which the sulphide is distilled off as hydrogen sulphide and absorbed in ammoniacal zinc sulphate solution, in which the sulphur content is determined iodometrically.

Two determinations which were subjects of discussion during the year were the determination of small amounts of chromium in ilmenite and similar concentrates, and the analysis of petalite for its lithium content.

In the first the importance lies in the very detrimental effect that even small concentrations of chromium have on the quality of white pigment produced from titanium minerals. As overseas specifications call for a chromium oxide content of less than about 0.1 per cent. sensitive and reproducible analytical methods are essential. A local producer of ilmenite concentrates had ex-

pressed concern at the variation in chromium figures on the same sample reported from different laboratories and so a collaborative programme with the C.S.I.R.O. Division of Mineral Chemistry in Melbourne was initiated. Atomic absorption and two variations of the diphenylcarbazide colourimetric method were used. Investigation into the determination by atomic absorption, following decomposition by fusion with potassium bisulphate, showed that interferences from iron, titanium and sulphate could be overcome by using the nitrous oxide-acetylene flame. Using this technique a series of figures was obtained showing an average Cr_2O_3 content of 446 p.p.m. with a relative deviation of 1.8 per cent. C.S.I.R.O. figures from atomic absorption analyses showed 438 p.p.m. Cr_2O_3 . By colourimetric methods figures reported were 431 p.p.m. by this Division and 438 p.p.m. by C.S.I.R.O.

From this work there seems little doubt that satisfactory agreement can be obtained between different laboratories and different methods for the determination of trace amounts of chromium in ilmenite and similar concentrates.

Appreciable tonnages of petalite were exported from Western Australia during the year. The company concerned reported differences in lithium figures between buyers and sellers on the same shipment, also differences between local laboratories. Though in such cases some doubt can be felt that the various analysts may not be working on truly identical samples it was considered that, as in the case of chromium in ilmenite shipments, a collaborative analytical programme would be justified. Here again, the co-operation of Mr. E. Pilkington of the C.S.I.R.O. Division of Mineral Chemistry was sought and readily given while a private laboratory undertook to recruit further analysts to participate.

The method used consists of attack with hydrofluoric and perchloric acids, followed by atomic absorption readings from a dilute perchloric acid solution, using the air-acetylene flame. The only problems envisaged are incomplete dissolution of the original sample and possible interferences from other alkalies in atomic absorption readings.

Results obtained by the Division, after eighteen determinations involving five different chemists, gave a lithium oxide, Li_2O , content of 3.73 per cent on the test sample, with a standard deviation of 0.06 equivalent to a relative standard deviation of 1.6 per cent.

C.S.I.R.O. reported 3.75 per cent Li_2O but unfortunately no figures were forthcoming from private analysts.

Another analytical investigation involved the determination of small titanium residues in monazite concentrates. Titanium is a penalty impurity in some specifications for monazite concentrates and an investigation was carried out to determine the effect of high concentrations of phosphorus and rare earths on its determination by the standard colourimetric peroxide method. This was considered necessary because of suggestions in the literature that such interferences could occur.

Results of the investigation showed that P_2O_5 , present in concentrations up to 100 times the TiO_2 , does not interfere. Nor was significant interference recorded when cerium and lanthanum were present separately or together at 75 times the TiO_2 concentration.

Work on vanadium analyses is described elsewhere.

Geochemical Analyses

Most samples for geochemical analyses were submitted as batches from the Geological Survey. The initial batch consisted of 529 drainage samples from an orientation programme in the Laverton and Leonora areas. Elements determined were copper, lead, zinc, nickel, cobalt, chromium, manganese, silver, molybdenum and iron. The method of analysis was a conventional geochemical pro-

cedure consisting of attack with perchloric and nitric acids followed by evaporation to dryness and final atomic absorption readings from hydrochloric acid solution. A preliminary statistical review of the method showed the following deviations.

	Mean	Standard deviation	Relative standard deviation per cent.
	parts per million		
Cu	18.8	1.1	6
Pb	19.5	1.9	10
Zn	34.9	2.4	7
Ni	28.4	2.1	7
Co	10.5	0.9	9
Cr	366	48	13
Mn	137	9.1	7
Fe	37,100	1,800	5

As the procedure essentially meets the Survey's requirement of a relative standard deviation not in excess of 10 per cent the method has been adopted as routine.

Maximum silver figure was 4 p.p.m. with the great majority less than 2 p.p.m. while molybdenum was not detected, detection limit of 5 p.p.m.

Mineral Identifications and Analyses

General.—Though there was a marked reduction in the number of samples submitted by the public for identification, there was a comparable increase in the number of specimens examined departmentally. Most of the latter were collected by members of the staff, others were donations offered by, or sought from, exploration and operating companies and prospectors generally. Co-operation by such donors is appreciated.

Only a selected few of the more interesting occurrences will be described.

An unusual number of the readily soluble sulphate minerals were examined, among them being apthitalite and ammonium apthitalite from Toppin Hill near Rason Lake, pickeringite from the Copper Head Mine at Bullfinch and, associated with chalcantite, from Murrin Murrin, epsomite and the magnesium-sodium sulphate bloedite from Carr Boyd.

Interesting occurrences of cave minerals included ardealite, brushite and gypsum from Weelawadji Cave, Eneabba and brushite, dahllite and taranakite from the Super Cave at Cervantes. Material from Toppin Hill mentioned above also contained phosphammite, weddellite and naturally occurring urea.

Rocks from the vicinity of Roebourne were of particular interest as regards their lapidary possibilities. One was composed essentially of zoisite, pink in patches and associated with green idocrase and grossular garnet. Such pink, manganese-bearing zoisite is often referred to as thulite. Similar material, pale green throughout had a jade-like appearance. A further sample also from near Roebourne, consisted of prehnite largely altered to fine-grained green mica.

Dravite crystals were identified from Yinnietarra. Crystals from this area have received world-wide notice in lapidary journals, and many are fully developed with bright faces and often doubly terminated. Crystals from this deposit measuring $2\frac{1}{2}$ in. x $2\frac{1}{2}$ in. x $2\frac{1}{2}$ in. are quoted in United States at \$22 each. A specimen examined was associated with phlogopite mica, green apatite, plagioclase, clinocllore, rutile and quartz.

Crystals of diopside were also received from Yinnietarra, one of which had been faceted to produce an acceptable gem.

A clear green spodumene in feldspar rock from Spargoville was associated with pink garnet and dark green mica. The spodumene could be classified as the hiddenite variety which includes the gem quality mineral found sparingly in Brazil and North Carolina.

A spectacular sample from the Mt. Goldsworthy area was composed of goethite layers with a little hematite, fine-grained quartz layers with dispersed goethite fibres and lenticular "tiger-eye" layers composed of fibrous quartz replacing crocidolite. Traces of the crocidolite could be seen in thin section. Repeated crushings and extractions of fibres from the "tiger-eye" yielded a fibrous sample which gave a strong X-ray diffraction pattern of quartz with also the main diffraction lines of crocidolite.

Another crocidolite sample from the Hamersley area occurred with banded ironstone in the form of a cone. These cone structures are abrupt local constrictions in crocidolite mesobands which are often superimposed on the more general variations of thickness occurring in rock of the Brockman Iron Formation.

Specimens of lithium-bearing minerals were obtained from an area two miles from the long established quarry at Londonderry. They included petalite assaying 4.78 per cent Li_2O with a light purple lepidolite containing 4.05 per cent, whereas a much darker lepidolite showed only 2.26 per cent Li_2O . Eucryptite from Londonderry assayed 9.71 per cent Li_2O .

The uncommon calcium aluminium silicate mineral pumpellyite had been recorded from only three W.A. localities, namely Roebourne, Mt. Edon and Coolgardie. During 1972 a fourth occurrence was recorded but the sample having been received from a native through the Department of Community Welfare no locality more detailed than East Kimberley was available. This is particularly unfortunate in that the specimen represented an unusual form of an unusual mineral. It occurred in fibrous radiating aggregates, with unusually high refractive indices $\delta = 1.73$ $\beta = 1.72$ and was optically negative whereas the normal form is positive.

A specimen from the Londonderry feldspar quarry, collected some years ago, was known to contain cassiterite, bavenite and bityite and also some unidentified species. The latter were re-examined using X-ray diffraction techniques and varlamoffite and pucherite identified. There was also a brown isotropic resinous mineral, probably a complex tin hydroxide, whose diffraction pattern was similar to that of $\text{NiSn}(\text{OH})_6$, ASTM No. 20-795.

A suite of minerals collected from Yinnietharra and Eudamullah stations included chrysoberyl, spessartite, beryl and columbite from White Well epidote crystals and feldspar with zoisite inclusions, actinolite, tremolite varieties, and from Yinnietharra pegmatites, a range of beryls, tourmalines and feldspars. Massive garnet, including uvarovite and a number of as yet unidentified minerals was collected near Pyramid.

Other specimens received include celadonite from Mundijong, metavariscite from Ragged Hills, stilbite from Norseman, takovite coating joints in gabbo from Carr Boyd and galena and cerussite from the Isabella Ranges.

Copper.—Partzite, a yellow-green hydrous copper antimony oxide, (associated with brochantite and tripuhyite) was identified for the first time in Western Australia in a sample received through the Department of Aboriginal Affairs. The sample was from the Dunham River area of the Kimberley and here again it is unfortunate but inevitable that most of the specimens found by natives, often mineralogically interesting and from remote localities, cannot be tied down to a specific point of origin.

One of the most spectacular copper specimens came from the 70 foot level of the Whim Creek mine. It consisted of radiating needles of malachite with black botryoidal manganese oxide and bipyramidal crystals of wulfenite.

Turquoise was recorded for the first time from Greenbushes in samples submitted by the Geological Survey. The turquoise was in weathered rock composed mainly of kaolin with black tourmaline and a little quartz and muscovite.

Paratacamite, as an alteration product of copper wire and sheet, came from the old Telegraph Station at Israelite Bay while a specimen from Glen Florrie contained digenite, cuprite, atacamite and azurite.

Mr. G. Cornish, of Aboriginal Affairs Planning Authority, donated a number of copper minerals from carefully identified localities in the Warburton Ranges. Most striking was a specimen of massive djurleite veined by malachite and blue opal with segregations of hematite, kaolin and anatase. It is the first time that djurleite has been identified in these Laboratories though owing to its similarity to chalcocite it is possible that its presence in earlier samples could have been overlooked. Until 1962 only three naturally occurring sulphides of copper were recognised, namely covellite (CuS), chalcocite (Cu_2S) and digenite ($\text{v}_{1.8}\text{S}$). In that year, djurleite was first described as a new mineral. It is very similar to chalcocite, with a chemical formula $\text{Cu}_{1.96}\text{S}$, and cannot be distinguished from it by normal microscope techniques but there are quite marked differences in X-ray diffraction patterns. Chenevixite, a green hydrated arsenate of copper and iron was identified in a sample from near Ashburton Downs homestead. It was associated with quartz and smaller amounts of yellow beudantite and scorodite.

Gold.—The number of gold assays (249) carried out was about double those for each of the two previous years.

Of the ores received, about half were assayed at concession rates of \$2 per sample, being submitted by individual prospectors who were not working on claims and who revealed the locality from which the samples originated. The majority showed trace amounts only. The best grade materials came from the vicinities of Eristoun (45 dwt/ton), Lake Darlot (25 dwt/ton) and Yalgoo (19 dwt/ton).

A few batches were assayed for exploratory companies and a number for laboratories requiring standards for their gold determinations by atomic absorption.

One particularly complex sample from Bullfinch consisted of quartz with fibrous tremolite and mica and much chalcopyrite and porous pyrite with a little marcasite and galena. The marcasite had oxidised in part to yellow natrojarosite. Gold occurred as numerous thin inclusions 2 to 30 microns long, almost exclusively in the galena. The sample assayed 61 dwt of gold per ton.

Work being carried out by the Engineering Chemistry Division on the retreatment of Wiluna dumps has provided some interesting samples for gold assay. They have varied from milligram quantities of settled deposits to large volumes of solutions often high in acid and dissolved salts.

In the case of some solutions very low in gold resort has been had to the Denver precipitation method to give a preliminary concentration before fluxing and firing, with results duplicating well.

Most tailings assayed were for the State Batteries Branch, for whom 35 check and 12 umpire assays were made.

Limestone.—Ferrous iron and carbon dioxide were determined on thirty-five samples of limestone submitted by Geological Survey in connection with a survey of limestones in the North West Division. The FeO content ranged from about 0.1 up to 2.1 per cent, the CO_2 from 20 to 46 per cent.

Four limestone samples were examined for Public Works Department in connection with compensation claims on resumed land in the Kwinana area. The samples were from the surface (cap rock) and from depths of 3, 10 and 20 feet. Calcium carbonate content, porosity and bulk density were required. The specified method defined calcium carbonate as that fraction of the rock soluble in dilute hydrochloric acid and porosity as the ratio of volume of voids to total bulk volume. The method specified for determining bulk volume, namely saturated weight in air minus saturated

weight in water, assumes that no voids are completely sealed against access of air and water. Figures obtained by those methods were:

	Calcium carbonate	Porosity	Bulk density
	per cent	per cent	lb./cu. ft.
Caprock	87.1	32	114
3 ft.	82.5	42	97
10 ft.	83.6	47	88
20 ft.	84.1	46	89

Three samples from Wanneroo were examined for the State Mining Engineer with reference to a royalties investigation.

The sodium chloride content of a sample of limestone from the Exmouth area was found to be 30.2 per cent.

Radioactive Minerals—Radioactive samples from the Mundong Well area were received from a number of sources. In all cases, the main uranium-bearing mineral proved to be kasolite, a hydrous lead uranium silicate not previously recorded from Western Australia. The specimen submitted by the Geological Survey was massive fine-grained quartz containing a few black veins of kasolite-cerussite-chalcoite intergrowth, thin green veinlets of malachite and a yellow patch of kasolite and duftite (basic lead copper arsenate). No pure kasolite was separated for analysis, but the whole specimen as received gave the following partial analysis:

Uranium oxide, U ₃ O ₈	per cent.	3.60
Lead, Pb	5.97	
Copper, Cu	5.38	
Zinc, Zn	parts per million	30
Gold, Au	1.8	
Silver, Ag	54	

Rare Earths—The rare earth carbonate, bastnaesite, was recorded for the first time in Western Australia in a sample received from Edmund Station. The sample was monazite with intergrown bastnaesite and goethite, and veins of chalcedony.

It did not prove possible to separate sufficient pure bastnaesite for analysis but the whole sample assayed as follows:

Rare earth oxides	per cent.	33.9
Thorium dioxide, ThO ₂	0.27	
Phosphorus pentoxide, P ₂ O ₅	14.8	
Silica, SiO ₂	26.1	
Carbon dioxide, CO ₂	0.28	

Theoretical calculations from the above figures indicated an approximate mineral analysis of

Monazite	per cent.	49
Bastnaesite	1½	
Iron oxides	20	
Quartz, silicates	29½	

The monazite was calculated to contain 69 per cent rare earth oxides with only about 0.5 per cent thorium dioxide.

As the ratio of rare earth oxides to thorium dioxide in monazites mined commercially in Western Australia is between 8 and 9 the above sample represents a monazite of unusually low thorium content.

Vanadium—The majority of vanadium determinations were carried out in connection with investigations by Engineering Chemistry Division on various aspects of the treatment of W.A. vanadiferous magnetites.

At the request of the sponsors of this investigational work the Division co-operated in an inter-laboratory check on analytical procedures.

Agreement between laboratories on the vanadium content of samples has not always been good and so two samples, one of untreated ore and one of a

roasted metallurgical product, were circulated for assay at four other laboratories as well as the Government Chemical Laboratories.

Choice of method was left to the individual laboratory and so a comparison of methods as well as analysts was obtained. The methods used were volumetric, atomic absorption and X-ray fluorescence. Summarized results are tabulated below expressed as per cent V₂O₅.

Laboratory	Ore			Metallurgical product		
	Volumetric	Atomic absorption	X.R.F.	Volumetric	Atomic absorption	X.R.F.
A	0.82	0.86
B	0.84	1.00
C	0.84
D	0.82	0.98
GCL	0.85	0.85	0.84	0.99	0.99	0.98

These results indicate that agreement is on the whole satisfactory. As in previous work, it was found that high temperature treatment of some metallurgical products produces a highly refractory material very resistant to acid attack.

The method adopted for general analyses of investigational samples was sodium peroxide fusion followed by water extraction and volumetric determination of vanadium in the filtrate.

In addition to vanadium (both total and water-soluble) the following were determined on a percentage of these samples—titanium, iron (total and ferrous), aluminium, silica, calcium, sodium, sulphur (elemental and as sulphate), chlorine and ammonia.

A titaniferous magnetite submitted for examination by a member of the public showed the commercially interesting analysis of Fe₂O₃ 77.8, TiO₂ 14.8 and V₂O₅ 1.18 per cent.

Miscellaneous

Building Materials—Most samples under this heading consisted of potential concrete aggregates including sand, shingle or crushed rock.

The main source was the Main Roads Department, with some samples submitted also by State Housing Commission, Commonwealth Department of Works and the Geological Survey. All samples were tested for alkali reactivity by the short chemical method, while eight samples were subjected in addition to the mortar bar test.

Of the 57 aggregates tested chemically for reactivity, 43 were innocuous, 11 marginal and 3 reactive. The three reactive samples were river shingle from Robe River composed mainly of banded chert pebbles with some quartz and quartz-chlorite rock, scree from a hillside near Strelley composed mainly of serpentinite rock fragments containing antigorite and magnetite and occasional fragments of chalcedony and, thirdly, material stockpiled at Yule River containing quartz (some very fine-grained) feldspar, chlorite and goethite. The last, when used to make mortar bar test pieces, did not however show excessive expansion after 46 weeks and so again confirmed our previous experience that the chemical test, though it may condemn an innocuous aggregate, is most unlikely to pass a deleterious one.

A vesicular basalt, with cavities partly filled with quartz, chalcedony, and calcite was considered borderline.

One artificial product, blast furnace slag, was tested as a potential concrete aggregate. Chemical tests showed that it did not react deleteriously with alkali and mortar bars using it as aggregate showed no expansion after 4 months.

As well as potential reactivity tests a number of aggregates were examined for conformity to Australian Specification A.77 involving also sizing and organic content, including sugars.

A request was received from Public Works Department to examine samples of cement render from buildings on Rottnest which was showing discoloration due to a surface efflorescence. The render was found to be composed of quartz and

feldspar with calcium silicates, sulphur and a little gypsum. As the use of sulphur as a colouring agent is not standard practice it was recommended that the original desired colour could best be achieved by using white cement and yellow sand, with the possible addition of small amounts of yellow ochre.

Two granite samples from different localities were submitted for comparative tests regarding water absorption, porosity and density. The granite was to be used as an exposed aggregate in large polished concrete slabs for constructional and ornamental purposes.

The specific gravities were 2.65 and 2.58 and water absorptions were 0.17 and 0.22 per cent respectively. The "porosities" were compared by measuring the volume of water absorbed over a polished area under a head of 20 cm at chosen intervals of time. The rock having a specific gravity of 2.65 absorbed 37 cm³ per m² in 3 hours and 60 cm³ per m² in 6 hours whereas the less dense rock absorbed 109 and 187 cm³ per m² respectively during the same periods.

Dusts.—Practically all of the dust samples submitted were from Public Health Department, some originating from Mines Inspectors.

Of the 1047 samples involved, the big majority were in connection with air pollution generally but 75 dealt with industrial toxicology and direct health hazards.

Regular monitoring of dust in the ore loading areas at Port Hedland and Esperance resulted in in about 400 samples from CERL gauges being analysed for iron and manganese in the case of Port Hedland and for nickel, copper and iron in dusts from Esperance.

Most other dust samples had been collected on filter papers by a variety of dust sampling devices. The majority of these (about 450) were 13 cm papers used in sampling city air for lead, the lead being determined by atomic absorption after complete destruction of the paper by suitable acid attack.

Other samples submitted dealt with health hazards from a number of materials.

When free silica was required both chemical and optical means were used, depending on the nature of the sample but in many cases neither technique was applicable due to the very small total weight and particle size.

The problem of the quantitative measurement of quartz in such samples should be overcome by the installation in 1973 of X-ray diffractometry equipment. With these facilities available a large increase in samples originating from Public Health Department silicosis surveys could be expected.

Fifteen samples, from 8 different sources, were received, either for identification of the type of asbestos present or for estimation of the fibre density in dust samples. The samples were from engineering workshops, firms fabricating or dressing asbestos products, mines and from areas being sprayed with asbestos compounds. Chrysotile and anthophyllite were the asbestos species identified, no crocidolite was detected.

Lead was determined in dusts from a battery assembly workshop, plastic firm, printing company and gold mining assay rooms. Figures from the last mentioned source indicated lead contents ranging from 0.1 to 3.7 milligrams of lead per cubic metre of air, the origin being the litharge used extensively for fluxing purposes.

Other work concerned with health hazards included determinations of the uranium content of dusts from developmental work on radioactive ore deposits and from sample preparation areas of laboratories concerned with analysis of uranium ores.

Metals and Alloys.—Most work in this field was in connection with an investigation by the Dental School of the University of Western Australia into possible compositional changes occurring in nickel based dental casting alloys during various casting procedures.

The main samples examined were an original ingot of alloy and three ingots resulting from the fifth of a series of recastings at the Dental School by three different techniques. Examinations were made of polished and etched surfaces and photomicrographs produced at magnifications ranging from x 130 to x 1000.

Chemical analyses were carried out on each of the four samples and showed differences in aluminium, beryllium, silicon, carbon and nitrogen contents between the original and the remelted samples. Analysis of the original alloy gave the following results:

	per cent
Nickel, Ni	69.3
Chromium, Cr	16
Molybdenum, Mo	5.4
Manganese, Mn	3.9
Aluminium, Al	2.89
Iron, Fe	0.24
Beryllium, Be	0.58
Silicon, Si	0.51
Carbon, C	0.17
Nitrogen, N	0.02

Analyst: M. B. Costello

The nitrogen content, significant as regards the formation of nitrides, showed up to a four-fold increase with recasting. Its determination at low concentrations in such a refractory alloy poses an interesting analytical problem both as regards decomposition and avoidance of blanks. The method used was based on attack of the alloy with potassium chromate, phosphoric acid and hydrofluoric acid. Following expulsion of the hydrofluoric acid the sample was transferred to a steam-distillation apparatus, made alkaline and the nitrogen distilled as ammonia which was then determined colourimetrically.

Other work on metals included the determination for Public Works Department of the nature, thickness and weight per unit area of a coating on mild steel plate, and the measurement by micro-section of the thickness of an anodised coating on aluminium.

Police Cases.—Exhibits were examined for the Criminal Investigation Branch in connection with alleged arson, breaking and entering, damage to property and rape.

Much of the work in connection with arson consisted in the comparison of paint remnants. In one case, paint flakes were shown to consist of three color layers white, green and black, the pigment in the white layer being titanium dioxide and in the other layers chromic oxide. In other cases, barium sulphate and calcium carbonate were pigments common to flakes from various sources, while the presence of barium sulphate, lead carbonate, iron oxide and titanium oxide in the residue from an explosion was consistent with the burning of paint.

Exhibits were submitted relating to an attempt to produce an explosion in a public building. A metallic powder consisted of aluminium powder, charcoal, potassium chlorate and silver chloride, a yellow powder was found to be picric acid and a third exhibit was ammonium nitrate impregnated with fuel oil—all substances capable of powerful explosive effects under the right conditions.

Three exhibits relevant to a breaking and entering charge were shown to contain basically the same components from the same environment and included paint flakes, microfossils and magnetic globules.

Fibres taken from clothing, car interior and at site of a burglary were found to be identical as regards nature, colour range, average diameter and birefringence.

A considerable number of samples were submitted by the police in connection with a case alleging false statements by a member of a mining company. About 300 chemical analyses and 60 de-

tailed mineralogical examinations were involved, the results of which comprised much of the technical evidence given subsequently in Court.

The time spent by Divisional staff in attending courts to give expert evidence was far greater than average during the year, due largely to involvement in the latter case.

WATER DIVISION.

The analytical efficiency of the Water Division, after obtaining an Atomic Absorption unit during 1972, is not retarded at present by lack of equipment.

The immediate future could involve substantial increases in the number of samples to be analysed and components to be determined in each sample as the result of sampling and analytical programmes being planned through the Australian Water Resources Council. If the Western Australian samples are analysed here this could ultimately involve the Water Division in an additional 5,000 to 10,000 samples annually. This will necessitate the use of automated analytical equipment for which some additional staff and space will be required.

Mr. K. Browne was promoted from Technician to Chemist and Research Officer and Mr. D. Fleming was appointed to the consequent vacant Technician position. This staff increase was necessary because of the increase in the number of samples associated with pollution together with the continued increasing role of senior members of the staff in an advisory capacity for problems associated with water treatment, corrosion and pollution.

The three senior members of the Division are still actively involved with committees and organisations associated with the above aspects and a number of addresses have been given to various organisations.

Mr. P. Jack attended the 5th International Congress on Metallic Corrosion during his holiday in Japan in May and Mr. C. Weir attended the 5th Federal Convention of the Australian Water and Wastewater Association in Adelaide in June.

Table 21 indicates the source, number and type of samples received during the year. Although the Table reflects no major alterations from that of 1971, other than slight increases in total numbers, there has been an increased involvement of senior staff with water treatment trials. Apart from planning the trials, collection and analysis of a large number of samples is involved for each trial. This appears as only five samples in Table 21.

The following report includes only the most interesting highlights of the year's activity and is not intended as a complete summary.

Public Water Supplies

1. Salinities of hills source reservoirs.—The Table below shows the average salinity values from January to December 1972 of the surface water from the four major dams in the Darling Ranges providing reticulated water. These are now at their highest ever salinity levels. This has no doubt

been caused by a series of lower than average annual rainfalls coupled with little or no overflow.

	Total salts-average parts per million
Canning	310
Mundaring	520
Serpentine	220
Wellington	550

2. Cadmium in drinking water.—Because of the relatively recent cadmium poisoning problems in Japan the World Health Organisation has set the maximum level in a potable water at 0.01 milligrams per litre. All source reservoirs and bores serving the Metropolitan Area were checked for this component and all contained less than 0.005 parts per million.

3. Phosphorus levels.—The generally accepted methods for the determination of various phosphorus fractions have not proved satisfactory, particularly with coloured waters. After some investigation it was decided that the only satisfactory method was to determine total phosphorus by perchloric acid digestion to fumes and to ignore the various forms. This change in method has given generally lower results than previously for metropolitan source reservoirs and bores, the source reservoirs now containing 0.01 parts per million or less. Bore waters containing iron have phosphorus levels up to 0.4 parts per million but after iron removal by aeration, sedimentation and filtration this value drops to less than 0.02 ppm. Iron-free bore waters have levels in the range 0.01 to 0.04 ppm. Algal growths are restricted where the phosphorus level is less than 0.01 ppm and the recently obtained results are in conformity with the areas where algal problems are experienced.

Water Treatment

1. Clarification.—By the end of the 1973-74 summer the Gwelup series of bores will be feeding a common water treatment plant at Gwelup with a capacity of 10 to 20 million gallons daily. This will augment the treated water from the Mirrabooka treatment plant which treats a series of bores from the Gnangara area and which has a similar capacity. The water in the Gwelup series mainly needs iron removal at an average level of 5 to 10 parts per million but that at Mirrabooka requires colour, turbidity and iron removal. The chemical properties of each of the bores feeding the separate plants are quite variable and it has been necessary to test separate bore supplies for various selected treatments as a representative blended supply has not been available.

(a) Mirrabooka.—A considerable amount of planning and investigation have gone into the assessment of the upflow clarifier performance. Upflow clarifier performance is considered satisfactory when the suspended solids content of the treated water is less than 5 parts per million, a quantity that can be satisfactorily removed by filtration. The tests have mainly involved the assessment of positioning steep angle tube settlers in the zone above the slurry pool. Contrary to general expectation the tube settlers did not

TABLE 21

	Agriculture Department	Fishes and Fauna Department	Metropolitan Water Board	Mines Department	Other Government Departments		Public		Peel Inlet Advisory Committee	Public Health Department	Public Works Department	Swan River Conservation Board	Total
					Federal	State	Free	Pay					
Corrosion	1	4	6	11
Effluent	1	30	2	11	44
Pipe	1	1	2	1	3	8
Soil	1	49	50
Treatment Chemicals	31	3	34
Water	55	28	1,527	401	6	22	579	53	942	2	3,615
Fluoridated	738	785	1,523
Pollution Survey—
Bunbury	48	48
Peel Inlet	39	39
Swan River	143	143
Various	2	6	1	4	15
Water Treatment Trials	5	5
	55	28	2,305	409	6	24	1	615	39	57	1,840	156	5,535

give the 2 to 3 fold improvement in plant throughput. The exercise led to a more fundamental understanding of the operating mechanisms involved and this subsequently led to future designs incorporating greater volumes for sludge collection and concentration. This lack of sludge concentrating volume restricted the plant capacity to 5 ft per hour upflow velocity instead of the 10 to 12 ft per hour attained with adequate volume. The floc at Mirrabooka would be considered a weak one and the settling tube manufacturers suspect that this is the reason for non improvement, which reputedly does occur in about 5 per cent of the cases where they have been installed.

(b) Gwelup.—Although jar tests have given a good guide to upflow clarifier performance in all instances of Western Australian potable waters so tested, an upflow clarifier pilot plant was supplied by the Metropolitan Water Board to collate performance data that could be incorporated in the design of the full scale plant. Pilot plant upflow clarifiers still have the disadvantage of not being able to scale down all mechanisms, particularly in the clarifier itself and although it assists in obtaining some design features it does not necessarily give a more accurate prediction of the maximum obtainable upflow velocities in the full scale plant compared to jar test results. Gwelup water requires only iron removal but the additional advantages of upflow clarifiers for removal of other potential contaminants such as bacteria gave it a decided advantage over "in line" filtration when a choice between the two procedures had to be made. Jar tests were performed on two of the bores from the Gwelup series, one an artesian that was comparatively simple to treat and the other a shallow bore that required more sophisticated treatment. Normal jar test flocculating periods had to be extended to 20 minutes for the shallow bore. From the results of jar tests pilot plant tests were carried out on the shallow bore. It was consistently observed that jar tests gave 2 to 3 fold the optimum upflow velocities obtainable in the pilot plant and the reasons for this have not been entirely resolved. The most promising treatment from jar tests was chlorine plus alginate but pilot plant tests did not consistently bear this out. Jar tests have also indicated a relationship between aeration, if any, and the order of addition of primary coagulants and coagulant aids.

2. Fluoridation.—Where fluoride has been dispensed by a solution feeder of sodium fluoride, control has been good but there have been some difficulties associated with some solid sodium silicofluoride feeders in country water supplies. This never has and never will result in overdosing. In the Table below are the average values of fluoride from fluoridated water samples submitted to these Laboratories and received during the period January to December 1972, together with the type of feeder and the intended dose.

Shipments of sodium silicofluoride are tested for feedability index, a function of the moisture and grain size, but unfortunately there are still some feeding problems with materials that pass the test. Investigations were carried out with additives to see if improvement in feedability could be effected. Addition of proprietary brands of siliceous material at rates of 0.1 to 0.5 per cent, which is equivalent to less than 0.005 parts per million in the treated water, improved the characteristics, and tests with these materials in the water supply plants are intended during 1973.

Fluoridated Supply	Method of Fluoridating	Number of Samples*	Mean Level	Intended Level
Perth	solid	700	0.76	0.8
Mundaring—Goldfields	solid	138	0.73	0.8
Wellington—Southern	solid	22	0.68	0.8
Albany	solid	192	0.66	0.9
Geraldton	solid	116	0.73	0.8
Collie	solid	53	0.93	0.8
Manjimup	solution	85	0.81	0.9
Esperance	solution	94	0.90	0.9

* These numbers do not agree with the fluoridated water numbers reported in Table 21 but this is because those reported in Table 21 included unfluoridated raw water samples.

3. Desalination.—The pilot plant desalination unit (sirotherm) continued operating during the year at the Attadale bore. The resin was replaced with a supposedly superior type to that originally used but the analytical results indicated this to be not so. Despite lower flow rates and longer regeneration periods the total salts content became progressively worse producing an average product water closer to 700 parts per million total salts than the originally obtained 500 parts per million from a raw water with 1160 parts per million.

4. Eaton Water Supply.—Previous bores for this supply contained approximately 20 parts per million of iron and an upflow clarifier with aeration, lime addition and sodium alginate gave a satisfactory performance. Subsequent deeper drilling yielded a water with only approximately 2 parts per million of iron. In terms of solids loading on a filter this quantity of iron is equivalent to 11 parts per million of alum and it is obvious that "in line" filtration is the choice of treatment. Subsequent increase of the iron level to 4.5 parts per million with continued production made the choice of "in line" filtration borderline. 4.5 parts per million of iron is equivalent to 25 parts per million of alum which is considered a borderline level for "in line" filtration. With filter rates of 200 and 260 gallons per sq ft per hour the all sand filter allowed 0.6 to 1.0 parts per million of iron to pass through. Our recommendation was to upgrade the filter sand and carry out trials at reduced throughputs, or to revert to chemical treatment with the upflow clarifier unit.

5. Polyphosphate addition to Wickham Town Supply.—Analysis and advice for the use of a proprietary brand of additive for the Wickham Town Supply was undertaken. Wickham, a coastal town in the Pilbara is fed from the Millstream water supply containing approximately 250 parts per million of temporary calcium hardness which causes scale deposition when heated, particularly in hot water systems. The material to be used was mainly sodium polyphosphate with some sodium carbonate. Although anti-pollutionists would not advocate its use there is no health hazard at the intended dosage level of 3 to 5 parts per million equivalent to 0.6 to 1.0 parts per million as phosphorus. The use of this chemical involves the principle of "threshold phosphate" treatment which reduces the tendency of the water to form excessive scale of calcium carbonate when heated. This was an ideal case to study the effect on hot water units as only part of the town was being so treated and it is intended to examine these after several years use. The alternative to "threshold phosphate" is to soften the water required for heating. This would be more expensive irrespective of whether small individual softeners were sited at each house solely for hot water use or whether the whole town supply was softened.

6. Treatment of Laporte Effluent.—Tests during the year showed that the present practice of spraying the acidic, iron containing effluent over set areas of the low quality limesand sited between the estuary and the ocean at Bunbury, made little or no change to the ultimate fate of the iron. The acidity of the effluent is being neutralised by the naturally occurring limesand but most of the iron moves through the neutralising media. Whether the ultimate fate of the iron is to channel horizontally and eventually reach the ocean at a point some distance seawards of the shoreline, or whether it will channel vertically through the sand and because of gravity differences continue through the water table, is not clearly understood. Tests showed that there was certainly some horizontal movement away from the spray area.

In an effort to ensure that the iron was retained on the beach sand the feasibility of mixing the effluent with sea water and allowing the precipitated iron to settle was studied. The theoretical dilution with sea water to provide adequate oxygen is approximately 150 to 1 and that required to increase the pH above 4.5 is approximately 250 to 1. In the actual experiments a dilution of 300 to 1 appeared optimum and gave a floc, after flocculating for approximately 1 hour, capable of settling at 5 ft per hour.

Corrosion

1. Copper Potentials in Perth Metropolitan Waters.—Pitting of copper reputedly occurs when its potential versus that of the standard calomel electrode in the water under test exceeds 150 millivolts. The potential developed by a freshly polished electrode in an unchlorinated Hills water at ambient temperature was usually in the range of zero to minus 50 millivolts. The Hills waters tested contained total salts in the range 150 to 300 ppm of which 80 per cent is common salt, NaCl, and had pH values between 6.3 and 7.3. The potential developed was found to be dependent on the following factors:

- (a) The degree of polish of the copper electrode: The potential increased with time. Over a period of a few months the potential could rise about 50 millivolts but extended periods did not appear to increase this further.
- (b) The quantity of chlorine present in the water: Chlorine at levels of 0.5 parts per million gave potential rises of up to 50 millivolts but at lower levels of about 0.1 parts per million the potential increase was proportionately lower.
- (c) The temperature of water: When the water was heated from 15 to 60°C the potential increased by approximately 75 to 100 millivolts.

Copper in Perth water at temperatures in excess of 70°C does suffer from pitting attack. The sum of the effects from the above variables could be capable of raising an unchlorinated water at ambient temperature on a freshly polished surface from approximately zero, to about 160 millivolts on an exposed surface in chlorinated water at a temperature of about 60°C.

2. Tube Corrosion in Swimming Pool Hot Water Boiler.—Maintenance of reserves of sodium sulphite or hydrazine in the boiler water was not being controlled despite doses of the oxygen scavenging material being many times that recommended. The external surfaces of the tubes were extensively corroded. Inspection of the system showed that the problem lay in the faulty design of the plant. The header tank had insufficient head to prevent air ingress through the seals of the recirculating pump during operation. The inlet side to these pumps was under a vacuum and the subsequent air entrainment into the boiler always ensured that the scavenger was rapidly depleted and that the boiler water was always saturated with oxygen at its temperature of operation. The recommendation to change the pump type or increase the "header tank" height are being undertaken.

3. Corrosion of Copper Ring Mains Hot Water Systems.—Despite frequent recommendations to the various responsible organisations to raise the pH value of the water in their hot water circuits from a neutral value to one where there is a slight positive Langelier Index at the maintained temperature this has generally not been carried out. During 1970 to 1972 Albany Regional Hospital, which had a corrosion history as severe as any, commenced such a treatment which involved the addition of 13 parts per million of caustic soda to raise the pH to 8.4. There has been a remarkable reduction in corrosion failures since that date, the last 12 months being completely free. Inspection of the pipe sections has revealed the expected fine layer of calcium carbonate deposit and no evidence whatsoever of pitting attack.

4. Asbestos Cement Pipe in Highly Aggressive Reticulated Water.—A sample of asbestos cement pipe that has been in a system reticulating water containing 200 parts per million of free carbon dioxide was examined. The attack on the 4 in. i.d. pipe of original thickness 0.46 in. had obviously penetrated uniformly to a depth of 0.057 in. after 14 months service. The internal surface was still intact but the calcium content of the apparently attacked surface was 2.4 per cent compared to the original material with 16.1 per cent. If this rate of attack was linear the pipe would fail within 8 years but such attacks are normally not linear. The makers of the pipe expect a life in this environment in excess of 15 years.

5. Excessive Corrosion of Water Meters at Capel and Eaton.—Because corrosion of copper alloys in water at neutral pH values is generally proportional to the oxygen content of the water it was thought that the water supplies at Capel and Eaton which are pressured by compressed air instead of gravity tanks could be more corrosive. Water meters at these two country towns are corrosively attacked more than at other areas in the State. Examination of the plant log books and analysis of the water showed that the average increase of dissolved oxygen in the water from the compressed air system was only of the order of 0.5 parts per million from an already saturated figure of 8 parts per million. The slight oxygen increase could not alone account for the excessive corrosion observed in the meters.

Environmental Monitoring and Pollution

There was a considerable increase in the number of areas where pollution aspects were studied during 1972.

1. Estuarine Samples.—The Swan River and Leschenault Inlet at Bunbury, continued to be sampled at 3 and 6 monthly intervals respectively and during 1972 sampling of the Peel Inlet at Mandurah commenced at 3 monthly intervals. Samples from Mandurah include the Serpentine, Murray and Harvey rivers. The results to date for Mandurah are not unexpected and do not indicate any significant pollution areas. The results will serve as background values for predicted future development, particularly in the Murray-Yunderup area.

2. Shallow Bores in the Metropolitan Area.—The eight sites selected in 1971 were again sampled in 1972 and there was only slight alteration from the earlier report. The bore sample at Beenyup contained a confirmed level of arsenic at 0.02 parts per million which is well below the maximum level in a drinking water of 0.05 parts per million.

3. Water Level Sampling Sites.—These sites of the Metropolitan Water Board were sampled from the top six inches of the water table and tested for nitrate. Of the original samples taken in May-June, nine containing nitrate in excess of 40 parts per million were resampled in June and October. The June and October samples generally showed lower levels of nitrate and this could be accounted for by dilution of septic tank drainage into the water table by the penetration of winter rains. The nitrate levels in these samples are assumed to be mainly due to septic tank effluent, which as it leaves the septic tank with about 100 parts per million of total nitrogen, predominantly in the ammonia form, is capable of forming 400 parts per million of nitrate as NO₃.

Notable exceptions were a site adjacent to the sewage works at Shenton Park and from a recent housing development at Kardinya which was once an area of intense agricultural activity. The levels of nitrate at these two sites was consistently of the order of 500 and 200 parts per million respectively.

4. Industrial Fluoride.—A sample of surface water from an industrial area adjacent to an ilmenite plant at Capel proved to contain fluoride at a level that would certainly be harmful to both stock and vegetation. This particular plant was using hydrofluoric acid during the separation process and this was responsible for the contamination. The use of lime with or without iron addition was not capable of removing the fluoride to its theoretically soluble level of less than 2 parts per million in the effluent and the Company was forced to resort to its original practice of using hydrochloric acid in the separation process.

5. Farm Dam Contamination.—Regular sampling of waters from 24 farm dams in the Narrogin area commenced during 1972. The samples will be taken at season extremes plus additional sampling during the most troublesome period of flash summer run-off. There was no flash summer run-off up to December 1972. The sites were selected because of the variable conditions associated with their water catchment. Together with the chemical

work being undertaken, algal and bacterial examinations are being made. By general standards some of these dams would be considered chemically polluted but do not appear to have any harmful effect on stock.

6. South West Irrigation Areas.—Samples of the main rivers serving these irrigation areas in the Pinjarra-Brunswick area are being analysed. The sampling sites are selected to cover the water before and after movement through the irrigation area. The components selected for determination are colour, turbidity, salinity, nitrogen fractions, phosphorus and pesticides where applicable.

7. Alumina Refinery Mud Disposal Area.—Bore sites adjacent to the alumina mud disposal area at Mandogalup are being regularly tested for pH, salinity, alkalinity, calcium and magnesium, also the Murray river from selected sites in the Pinjarra alumina refinery disposal area. Caustic soda leakage would initially show up as slight increase in pH values, followed by reduction in calcium and alkalinity levels, then reduction in magnesium levels followed finally by substantial pH and alkalinity increases.

8. Upper Swan Wildlife Sanctuaries.—The sanctuaries at Ellen Brook and Twin Swamps are being regularly analysed for salinity, chloride, sulphate, fluoride, nitrogen fractions, phosphorus and organic material. These sites were originally selected because of the proposed location of the Pacminex Alumina refinery but will continue to be sampled for background information for other potential industrial pollution.

9. Mercury.—Mercury levels for some underground and sea waters were determined but there were no instances where the level was higher than that naturally occurring.

Miscellaneous

1. Methods Investigations.—(a) Due to the increased interest in mercury pollution considerable experimentation was carried out to ascertain the optimum conditions for the flameless Atomic Absorption method for the determination of inorganic mercury. The best method of converting organic forms to the inorganic form for determination and the best methods for collection and storage of samples were also thoroughly investigated. Although some organic forms are more toxic than others, this common grouping will frequently obviate the necessity to subdivide into the separate constituents.

Tests carried out showed that the persulphate-sulphuric acid digest was capable of oxidising monomethyl, dimethyl and phenyl mercury forms whereas permanganate-sulphuric was not. The containers for collecting samples and carrying out determinations should be acid washed glass and definitely not plastic. Some types of plastic stoppers may contain mercury compounds which will contaminate the sample and give high results. It is intended that this experimentation will be submitted for publication during 1973. The best acid for preventing absorption on polythene containers was hydrochloric whereas with glass there was little or no absorption with or without acid.

(b) The present accepted standard methods for the various phosphorus forms are all found to be unsatisfactory when the water is coloured due to organic matter. Unfortunately this occurs in many cases where pollution or ecological studies are being made. The significant levels of phosphorus are of the order of 0.01 parts per million and errors introduced by various methods may be well in excess of this. It was decided that the only meaningful result was to convert all the organic and polyphosphate forms to the orthophosphate form by perchloric acid digestion. The molybdenum blue colour complex using ascorbic acid is a sensitive method with a precision of 0.002 parts per million. Saline waters need a modified treatment involving larger quantities of perchloric acid because of acid losses as hydrochloric acid. Absorption effects with saline waters were found to be negligible in both plastic and glass sample containers after a period of 3 weeks storage at phosphorus levels in excess of 0.1 parts per million.

2. Permanent White Staining of Nursery Plants.—Several waters in the Canning Vale area being used for overhead sprinkler irrigation of nursery plants have caused permanent blotchy white stains on the foliage. This stain was not soluble in water but was soluble in dilute acid. It was identified as calcium carbonate which forms during the evaporation of the last drops remaining after the irrigation has stopped. These waters have calcium levels in excess of 50 parts per million and alkalinities between 100 and 150 parts per million. Softening the water was not recommended as the long term effect of irrigation with residual sodium carbonate would be detrimental. Although removal of bicarbonate with weak acid exchange resins would be ideal, batch dosing of the water with sulphuric acid was recommended as an economic measure. Treatment of only the last few minutes of the sprinkling period would be required to prevent the stain formation. The recommendation is being used and is quite satisfactory.

3. Red Deposit in Rainwater Tank.—An amorphous bright red deposit from a rainwater tank was found to be the encysted form of the free swimming green algae "Haematococcus". During cystation a red pigment "haematochrome" is produced. The alga is not toxic and to prevent its recurrence it was recommended that complete exclusion of light would give adequate control.

4. Deionised water.—A deioniser unit which was intended for use with artificial kidney machines was tested for the components shown in the Table below. These results show that this deioniser unit has a greater affinity for removal of calcium and magnesium but has a poor affinity for fluoride, particularly near the end of the run.

Component	Tap Water	Deionised			Exhausted
		End of Run	parts per million		
Calcium, Ca	3.8	less than 0.01	less than 0.01	0.02	
Copper, Cu	0.10	0.008	0.003	0.007	
Fluoride, F	0.80	0.01	0.15	0.77	
Magnesium, Mg	5.0	less than 0.01	less than 0.01	0.03	
Zinc, Zn	0.012	0.002	less than 0.001	0.003	
Total salts	160	1	5	6	

5. Taste Complaints in Albany Water.—Following taste complaints from people using urn water for brewing tea, an investigation was made of the changes that occur with prolonged boiling of the water from the Albany Town Supply. Albany supply has been partially softened leaving a sodium bicarbonate content equivalent to approximately 150 parts per million (expressed as CaCO₃). An artificial water was prepared and the results in the Table below show that with prolonged boiling there is almost complete conversion of the bicarbonate to the carbonate ion and consequent calcium carbonate precipitation. This means that there is now a considerable level of sodium carbonate in the water which imparts a distinct taste. The subsequent pH is well beyond the maximum of 9.2 recommended for a drinking water.

Time of Boiling (hrs.)	pH			
	nil	½	1½	3
pH	8.1	9.3	9.9	10.2
		parts per million		
Alkalinity—				
Bicarbonate	198	120	60	22
Carbonate	nil	35	95	135
Total	198	155	155	157
Calcium, Ca	20	2	1	1
Taste*	2/9	1/9	2/9	8/9
Smell*	0/9	0/9	3/9	3/9

* A panel of 9 tested the water and the ratio reported represents the number who noticed a smell or taste in the water at ambient temperature.

It is anticipated that such water used for brewing tea would additionally affect its extractive powers.

6. Recycled Sea Water in an Aquarium.—A seawater that had been recycled in an aquarium for a period of four months with only aeration and filtration had built up a nitrate nitrogen content of 77 parts per million equivalent to 341 parts per million of nitrate. This was apparently having no adverse effect on the health of the fish in the aquarium.

DIVISION VII

Annual Report of the Chief Inspector of Explosives for the Year 1972

The Under Secretary for Mines:

In accordance with Section 10 of the Explosives and Dangerous Goods Act 1961-1967, I submit for information of the Hon. Minister the following report on the work of the Explosives Branch for the year ended 31st December, 1972.

STAFF

The staff of the Branch remains unchanged with two professional officers, four general division inspectors and clerical staff of five members. The position of Inspector and Technical Officer was reclassified during the year with the new designation of Deputy Chief Inspector of Explosives.

The Officer in Charge of the Woodman Point Explosives Reserve, Mr. S. J. Wightman, retired in July after fifteen years of service in that position. The vacancy was filled with the appointment of Mr. C. M. Kerr as Officer in Charge and Sub-Inspector of Explosives.

The Safety Officer employed by the Port Hedland Port Authority was gazetted as a Sub-Inspector under the Explosives and Dangerous Goods Act for the purpose of inspecting the handling of explosives in the port area at Port Hedland as prescribed by the regulations under the Port Hedland Port Authority Act.

In February 1972 a Colombo Plan Fellow, Mr. K. S. Subramanyam, Senior Inspector of Explosives, India, was attached to the Branch for a period of ten days to study its activities.

LEGISLATION

No amendment was made to the Act but the Explosives Regulations were amended to provide for the issue of Shotfirer's Permits and to provide for stricter control of blasting operations at places other than mines. Several minor amendments were made to the Flammable Liquids Regulations and licence fees for both explosives and flammable liquids were increased at the end of 1972 by amendment of the schedules of fees.

Preliminary work was done on the conversion of all regulations to Metric System. No amendment of the Act will be required but conversion of the regulations will necessitate an extensive series of amendments. Serious consideration has to be given to the selection of each metric equivalent to be substituted for the original value and it is necessary in many cases to ensure that the new values will be consistent with corresponding values to be used by other States of Australia in their conversions. The Explosives Regulations have now been fully converted to metric system and work is proceeding on the Flammable Liquids Regulations.

AUTHORISATION OF EXPLOSIVES

Only one application was approved for authorisation of a manufactured explosive but amendments were made to the definitions of several explosives already authorised.

Authorised

Class 3—Nitro-compound, division 1.

Hi-Drive (ZZ)

Definitions amended

Exactex (ZZ)

Polar Quarry Monobel (ZZ)

Polar Semigel (ZZ)

Polar Monograin (ZZ)

MANUFACTURE OF EXPLOSIVES

Dynamite explosives, detonators and fuses are not manufactured in Western Australia but with the introduction of ammonium nitrate mixtures large quantities of Class 2 explosives are now being produced each year. Manufacture of simple nitrate-fuel oil mixtures was first carried out in small mixing plants at each mine or quarry site and this was referred to as on-site manufacture. Present developments indicate that the operators find it more economical to purchase the ready-mixed nitrate explosive directly from an experienced manufacturer who has established large bulk mixing facilities in various parts of Western Australia. Such mixing plants are regarded as factories and operate under a Licence to Manufacture Explosives at each site.

At some of the larger open cut mining operations nitrate-mixture and slurry explosives are manufactured under licence in mobile equipment which discharges the explosives directly into holes at the blasting site.

A licence was granted to Hamersley Iron Pty. Ltd. for the continued manufacture of a dry-mix aluminised nitrate explosive which had proved to be very successful after a lengthy period of trial and investigation which commenced in 1971.

Although it is not possible to report the total quantity of Class 2 nitrate explosives manufactured in Western Australia the magnitude of production and usage can be estimated from the 38,000 short tons of prilled Ammonium Nitrate which is known to have been used during the year for manufacture of such explosives.

Fireworks for local displays continue to be manufactured by the operators themselves in two small licensed factories outside the Perth Metropolitan Area.

IMPORTATION AND SUPPLY OF EXPLOSIVES

Western Australia continues to receive supplies of nitroglycerine explosives from the factory in Victoria and four shipments were made during the year. In each case the vessel called first at north-west ports such as Koolan Island, Broome, Port Hedland or Dampier for direct supply to those areas; the final delivery was then made to magazines at Woodman Point. There was also a continued supply to Woodman Point by rail conveyance from the Melbourne factory. Shipments were reduced during this year and almost half of the

explosives were consigned by rail. Explosives are also imported direct from factories in U.S.A. and one major shipment was received at Woodman Point during the year.

Although two overseas shipments of ammonium nitrate were received at the port of Dampier the large bulk of nitrate used in Western Australia is now produced at the Kwinana factory and distributed through the State by rail and road transport.

The attached summary shows the quantities of ammonium nitrate and explosives received for the year ended 31st December, 1972.

Ammonium Nitrate—

Total quantity used for blasting mixtures—
38,000 short tons.

Nitro-compound Explosives (Class 3 division 1)—

Total quantity received—1,806 short tons.

Marine Blasting Powder (Class 3 division 2)—

No importation, Marine seismic survey vessels were supplied from existing stocks.

Other Explosives.—Electric detonators, plain detonators, safety fuse and detonating fuse were received in considerable quantities as well as smaller amounts of other items such as blasting powder, rifle powders, whaling charges and special charges for firing in oil-wells.

Major importers of mining explosives are issued with a Licence to Import Explosives but the importers of occasional small consignments are accommodated by issue of an Entry Permit in respect of each importation. A total number of 21 Entry Permits were issued for such items as charges for oil wells, bon-bon crackers, special whaling explosives and display fireworks.

LICENSES AND INSPECTIONS

At the end of 1972 there were 533 licences current in respect of explosives which shows an increase of 48 compared with the total at the end of 1971. The distribution was as follows:—

Licences to Manufacture	8
Licences to Import	7
Licences to Manufacture Blasting Agent	110
Licences to Sell Explosives	54
Licensed Premises	45
Licensed Magazines	204
Licences to Convey Explosives	105
			<hr/> 533

Inspections were made of magazines and licensed premises where explosives are stored in all parts of the State and most of the inspections resulted in some action being taken to impress upon the licensees that magazines and stores must be kept in clean and safe condition. In many instances it was necessary to remove old deteriorated stock for subsequent destruction and to require removal of packing materials and general debris from the place of storage. In the course of such inspections the inspectors are frequently called upon to advise new storemen and staff members on matters relating to the general properties and characteristics of the explosives stored. It is also necessary to ensure that magazines continue to be secure and in good repair and that conditions on licensed premises have not changed in respect of fire risk and general security since the last inspection.

The inspectors investigated sixteen occurrences in which a total quantity of 657 lb. of explosives and 1,087 detonators were stolen from magazines and storage places. Where possible the inspectors made recommendations for greater security but generally the security was found to be satisfactory and regulations were complied with. It is evident that determined thieves can always gain access to explosives at certain places and improved security serves only as a deterrent to make the task more difficult. Without adequate security and control there is no doubt that more explosives would be stolen.

Inspections were made of explosives magazines and of on-site manufacturing operations in all parts of Western Australia and during the year the Deputy Chief Inspector made a special visit to Derby and Koolan Island which had not been inspected for some years. Much travelling over long distances is necessary to maintain even a reasonable coverage of all activities which concern the Branch; there is however a considerable advantage gained by the usual procedure of the inspectors working in the field of flammable liquids and inspecting explosives at the same time.

EXPLOSIVES RESERVES

At Woodman Point Reserve there were fewer shipments received than in past years and the quantities were on a reduced scale for each shipment since consignments are now made direct to north-west ports. Road deliveries both into and from the Reserve have increased very considerably due mainly to the quantities received by rail at Robb Jetty and the regular distribution of stocks by road conveyance to all parts of the State.

A new factory facility was established by I.C.I. Australia Limited within the Woodman Point Reserve for production of dry-mix explosive based on ammonium nitrate. This replaces the temporary mixing equipment which was operated on a trial basis during the previous year.

Necessary maintenance was carried out on rail lines, roadways and mechanical equipment during the year.

At Kalgoorlie and Port Hedland there are major Explosives Reserves which continue to be used by the manufacturers' agents for general bulk storage and distribution of explosives and small Reserves at Southern Cross, Meekatharra and Manjimup also continue to be used for bulk storage. Throughout all of the older gold-mining districts there are numerous small reserves vested in the Minister for Mines for the purpose of explosive storage. None of these older reserves is now used since either mining has ceased or explosives are stored in magazines on the mine leases. No objection has therefore been raised when applications are received for Mineral Claims which encroach on these Reserves.

EXPLOSIVES DESTROYED

On twenty-eight occasions during the year the inspectors found it necessary to confiscate and destroy a total of 4,190 lb. explosives and 1,400 detonators. In addition the usual sample material and explosives received from the Police were destroyed by the staff at Woodman Point.

About 150 pyrotechnic signals were received from the Harbour and Light Department for destruction but owing to age and some deterioration these were found to be dangerous when fired. Arrangements were therefore made to dispose of them by dumping at sea.

DISPLAYS OF FIREWORKS

Nineteen permits were issued for public displays and in each case the application was referred to local controlling authorities to ensure that there was not likely to be any undue hazard and that the location was considered satisfactory. Some few complaints were received from members of the public mainly in respect of noise caused by exploding fireworks. Such complaints are usually referred back to the local Councils and in some instances restrictions were imposed on future displays at the same location. There was one instance of a grass fire started by a public display but no injuries resulted from the use of fireworks. In this respect the legislation which banned shop-goods fireworks in Western Australia has been very successful. Injuries to children from fireworks have been eliminated and there is no evidence of any increase in the illegal manufacture of explosive or pyrotechnic devices by juveniles.

ANALYSIS AND TESTING

Since the Explosives Branch does not have facilities for laboratory analysis, samples of ammonium nitrate and other materials requiring chemical analysis are submitted to the Government Chemical Laboratories for examination and subsequent report to the Explosives Branch. The Branch technical officer carried out velocity and sensitivity testing at Woodman Point when necessary and during the year a total of 818 samples were submitted to the Abel Heat Test. Explosives consigned direct to north-west ports are sampled and heat tested by the Explosives Department in Victoria immediately before shipment and test certificates are received in this State before the explosives arrive at our ports.

Samples are received at regular intervals of ammonium nitrate produced at Kwinana and these are analysed at the Government Laboratories for total oxidisable matter and for oil absorption. It is very satisfactory to note that ammonium nitrate produced at Kwinana has always complied with the requirements of both the Australian Port Authorities Association and the Western Australian Government Railways.

All tests for the burning time of Safety Fuse which were made during the year gave results which were regular and consistently within the limits prescribed by the Regulations.

TRAINING COURSES FOR SHOTFIRERS

In 1971 the State Government Industrial Safety Committee requested that the Explosives Branch conduct training courses aimed at improving the standards of safe practice for shotfirers employed by Government Departments. Two courses each of three days' duration were held in 1971 and 32 men attended in that year. In 1972 the Branch was further requested to continue this work and two courses were held in May and August attended by a total of 32 men. These short courses of three days' duration do not constitute a full comprehensive training on all aspects of explosives and blasting practice; they are intended only to effect a general improvement in standards of shotfiring and to make the operators more conscious of safety.

During this year the Explosives Regulations were amended to provide for the issue of Shotfirer's Permits to men who have attained a standard of proficiency in the use of explosives. Such permits will soon become a statutory requirement on works to be controlled and regulated under the Construction Safety Regulations. Courses of instruction, consisting of seventeen evening classes, were commenced under control of the Technical Education Branch. Three complete courses were held this year. There was a total enrollment of 43 and 37 men sat for the examination. Of these 36 men passed successfully and at the end of the year 34 Shotfirer's Permits had been issued.

Training programmes have made heavy demands on the technical officer of the Branch this year and may have to be restricted to some extent to avoid neglecting the primary functions of the Branch.

ACCIDENTS AND EXPLOSIONS

Magazines Exploded by Fire

At a railroad construction site about 10 miles from Roebourne the main magazine and a detonator magazine were both destroyed by explosion when surrounded by a scrub fire. No person was injured and there was no damage to any other property. The licensee was reprimanded for failing to provide an adequate firebreak around the magazines.

Fire on Vehicle Conveying Ammonium Nitrate

About 170 miles north of Meekatharra a double bottom road train caught fire while conveying a total load of about 50 tons of ammonium nitrate. Fire was restricted to the second trailer unit which the driver succeeded in uncoupling and separating from the main unit. The fire then burned without explosion but with total loss of the trailer and about 24 tons of ammonium nitrate.

Outrage in Grocery Store

A general store in Attadale was damaged by an explosion on 13th March. It was believed that an explosive device was used but subsequent investigation at the site failed to produce any evidence of the nature of the explosive.

Telephone Box Wrecked

On 8th August a telephone box at Glen Forrest was completely wrecked by an explosion when vandals attempted to break open the coin operation box. An explosive charge had evidently been used.

Explosion Near Airport

On 10th August an explosion occurred on the ground directly in the line of flight for light aircraft when taking off from Jandakot Airport. From an inspection of the site it appeared that three 44 gallon drums of flammable liquid, probably a paint product, had been ignited and dispersed by an explosive charge placed under one of the drums and fired electrically. Samples taken at the site were examined by special techniques at the Government Chemical Laboratories and yielded some information on the nature of the drum contents. Investigations in this matter are being continued.

Bomb in City Building

When reports are received of bombs having been placed in buildings a thorough search is made by the Police. In most cases no bomb is found but on 24th August an effective time bomb containing about 15 pounds of explosive was located in a city building and was made safe for removal by Army personnel. No conventional authorised explosives were used in the bomb which consisted of improvised devices and mixtures which could nevertheless have operated quite effectively had the device not been discovered in time by the caretaker of the building. The Police have made charges in the case and legal action is proceeding.

Miscellaneous

In various instances the Branch technical officers assisted Police in their investigations by examining, and when possible identifying, materials collected from the site following an explosion.

FLAMMABLE LIQUIDS REGULATIONS

The total number of premises licensed for storage of flammable liquids has remained at about 5,000 and although 672 new licences were issued during the year there was a fairly large number of premises for which licences were cancelled owing to closure of business or because the owners preferred to discontinue storage rather than comply with the regulations. The four inspectors of the Branch have inspected licensed premises in all parts of Western Australia and have directed their efforts very effectively to a general improvement of safety standards and compliance with the regulations. The Branch received numerous requests from Councils and from Country Fire Services for assistance of the inspectors in application of the Flammable Liquids Regulations to particular storage problems in country towns. This shows very clearly the value of having one central controlling Department with inspectors having the same interpretation and thorough knowledge of one uniform code of regulations which is applicable in all parts of the State.

A total number of 3,646 premises storing flammable liquids were inspected and breaches of regulations were discussed with the licensees in a manner which in nearly all cases resulted in ready compliance within reasonable time. A persistent neglect to comply with requirements of an inspector is dealt with under section 51 of the Act which empowers the Chief Inspector to suspend a licence or to refuse renewal of a licence. The inspectors have by their tact and capacity for good public relations achieved a great deal in a comparatively short time without the need for any prosecution or legal coercion.

In this year it has become possible for inspectors to direct more of their attention to road conveyance of flammable liquids and since these do not involve licensed premises such inspections are not accounted for in the total number given above. It is conceded that much remains to be done in the field of road conveyance but already a large number of private contractors have been made aware that there are certain specific requirements made in the interest of safety which must be complied with.

Discussions with the W.A. Fire Brigade have continued in respect of the necessary fire protection for large tank installations and although such negotiations can continue for some time they are finally resolved by agreement to provide satisfactory protection for the type, size and location of the liquid storage.

In the City of Perth there were problems of hazardous storage and dispensing of motor spirit left as a legacy from past years but with the demolition of old premises and rebuilding which has intensified in recent years most of those problems have been removed. All new buildings and particularly industrial premises are now planned to comply with the regulations.

Much remains to be done before all storage and conveyance of flammable liquids is under complete control but the progress made in three years of operation is satisfactory and reflects greatly on the diligence and keen interest of the small staff concerned.

ACCIDENTS WITH FLAMMABLE LIQUIDS

There were no fires or fatalities directly connected with bulk storage depots or drum depots but the Branch technical officer was called upon to investigate and report on a number of fires and explosions which occurred at places where flammable liquids or similar dangerous goods were handled or used. Although only one of the occurrences was on licensed premises, it is the policy of the Branch to give technical assistance when requested by other State Government Authorities.

Hospital Explosion

Small quantities of volatile petroleum spirit were placed without cover in a refrigerator. The explosive atmosphere was ignited by a spark and the explosion blew off the refrigerator door and broke several windows but no person was injured. It was arranged that volatile liquids will in future be kept in effectively sealed bottles or containers.

Garage Workshop Fire

An elevated tank containing diesel fuel was involved in a fire which caused considerable damage to the premises. Although the tank was located in the yard, sparks from a grinding operation ignited oil soaked rags under the tank and there was spillage of fuel when the hose burned through because the shut-off valve had been left open.

Fatality in Plastics Factory

An employee died and the premises were destroyed by fire when flammable liquid used for manufacture of fibre-glass resin was ignited.

Polyester Resin Fire

The resin was in process of manufacture in an autoclave when it became overheated and was ejected into a catchment pit below the vessel. Spontaneous ignition of the hot resin may have occurred on contact with air or otherwise the hot resin may have vapourised residues of oil in the pit and caused ignition of the oil vapour.

Spontaneous Ignition

Rags which had been used for application of a wood staining preparation, ignited spontaneously in a house. Ignition was considered to have been aided by the high temperature and low humidity prevailing at the time.

Explosion in Dental Surgery

L.P. Gas leaked from a cylinder located in a small work room which was closed during the week-end. An explosion occurred when an assistant opened the door and operated the switch of an electric motor.

COMMITTEES LECTURES AND PUBLICATIONS

Standards Association of Australia

The Explosives Branch is now represented on the newly constituted Committee ME-17 and one general meeting of all members was held in Melbourne during the year. It is the intention of the new committee to revise the existing standard CB5 for Fuel Oil Burning Installations in a manner which will make it applicable to general storage of all flammable liquids.

Advisory Committee on Transport of Dangerous Goods

One meeting of this Committee was held in Melbourne and the Department was represented by the Deputy Chief Inspector of Explosives.

Committee of Flammable Liquids Statutory Authorities

No further meeting of the Committee was held this year but the Code for Tank Wagons designated as FL1001 was issued during the year and is in general circulation as a guide to the authorities and the manufacturers concerned.

Lectures to Trainee Detectives

The Deputy Chief Inspector of Explosives delivered two lectures to the Detectives' Training School at the request of the Police Department. The first lecture was given in August and was repeated in November.

Lecture to Shotfirers at Geraldton

At the request of the Public Works Department the Deputy Chief Inspector visited Geraldton in September and delivered a lecture on safe working with explosives to shotfirers employed on the Geraldton Harbour Development Project.

Army Fire Prevention Training

The Department of the Army organised a Fire Prevention Training Course in November. The Course was attended by representatives from all divisions and the Chief Inspector contributed one session concerned with the properties and fire risks of flammable liquids and gases.

Flammable Liquids and Fishermen

An article was prepared for publication by the Department of Fisheries and Fauna to direct attention of boat owners to the risk associated with liquid fuels.

Shotfirer's Training Courses

Details are given elsewhere in this report of two short training courses for Government Shotfirers and of three courses of night lectures which constituted full comprehensive training for issue of Shotfirer's Permits.

CONCLUSION

The Explosives Branch has changed considerably during the past ten years and its general functions are now applied to a more varied and wider field of work. There is now less attention given to the practical applications of explosives in underground mining than was usual in former years and although this is regrettable it is the inevitable result of increased responsibilities associated with the extended work of the Branch.

The Branch continues to receive excellent co-operation from all other Departments and Authorities with which it has a working association and it is recorded once again that all Inspectors and other staff members have given their utmost in serving the public with every personal consideration while at the same time maintaining due observance of the regulations which are directed toward the safety of life and property.

G. A. GREAVES,
Chief Inspector of Explosives.

15th March, 1973.

DIVISION VIII

Report of Superintendent, Mine Workers' Relief Act, and Chairman, Miners' Phthisis Board 1972

Under Secretary for Mines:

1. I submit for the information of the Honourable Minister for Mines my report of this Branch of the Mines Department for the year, 1972.

2. General

The State Public Health Department, under arrangements made with this Department, continued the periodical examination of mine workers throughout the year and mines at Kalgoorlie, Kambalda, Nepean, Scotia, Leonora, Norseman, Widgiemooltha, Esperance, Amery, Herne Hill, Kwinana, Mundijong, Jarrahdale, Bunbury, Capel and Greenbushes were visited by the mobile X-ray unit.

3. Mine Workers' Relief Act

3.1 Total Examinations

The examinations under the Mine Workers' Relief Act during the year totalled 4,982 and compared with 4,265 for the previous year; an increase of 717. The results of examinations are as follows:—

Normal	4,647
Silicosis early previously normal	20
Silicosis early, previously silicosis early	306
Silicosis advanced, previously normal	—
Silicosis advanced, previously silicosis early	5
Silicosis advanced, previously silicosis advanced	2
Silico-tuberculosis, previously normal	—
Silico-tuberculosis, previously silicosis early	—
Silico-tuberculosis, previously silicosis advanced	—
Silico-tuberculosis, previously tuberculosis	—
Tuberculosis, previously normal	—
Asbestosis early, previously normal	—
Asbestosis early, previously asbestosis early	—
Asbestosis advanced, previously normal	—
Asbestosis advanced, previously asbestosis early	—
Silico-asbestosis early, previously normal	—
Silico-asbestos early, previously asbestosis early	—
Silico-asbestosis early, previously silicosis early	—
Silico-asbestosis early, previously silico-asbestosis early	2
Silico-asbestosis advanced, previously silico-asbestosis early	—
Silico-asbestosis advanced, previously silicosis early	—
Silico-asbestosis plus tuberculosis, previously normal	—
Silico-asbestosis advanced plus tuberculosis, previously silico-asbestosis early	—
Total	4,982

The 1972 figures, together with figures for previous years are shown on the table annexed hereto. Graphs are also attached illustrating the trend of examinations since 1940.

3.2 Analyses of Examinations

In explanation of the examination figures, I desire to make the following comments:—

3.2.1 Normal, etc.

These numbered 4,647 or 93.30% of the men examined and include men having first class lives or suffering from fibrosis only. The figures for the previous year being 3,915 or 91.80% of the men examined.

3.2.2 Early Silicosis

These numbered 326 of which 20 were new cases and 306 had previously been reported; the figures for 1971 being 338 and 15 respectively. Early silicotics represent 6.50% of the men examined, the percentage for the previous year was 7.93%.

3.2.3 Advanced Silicosis

There were 7 cases reported 5 of which advanced from early silicosis. Advanced silicotics represent 0.15% of the men examined, the percentage for the previous year being 0.16%.

3.2.4 Silicosis Plus Tuberculosis

There were no cases reported. This compares with the year 1971.

3.2.5 Tuberculosis only

There were no cases reported. This compares with one in 1971.

3.2.6 Asbestosis

There were no new cases reported.

3.2.7 Silico Asbestosis

Two cases were reported of which none were new cases.

4. Mines Regulation Act

4.1 Total Examinations

Examinations under the Mines Regulation Act totalled 4,683. There was a decrease of 1,735 under this Act in 1972 as compared with 1971.

Of the total of 4,683 examined, 4,272 were new applicants and 411 were re-examinees. In addition, Provisional Certificates were issued to 572 persons in isolated country areas.

4.2 Analyses of Examinations

Particulars of examinations are as follows:—

4.2.1 New Applicants

Normal	4,267
Silicosis early	1
Silicosis early with tuberculosis	—
Tuberculosis	4
Other conditions	—
Total	4,272

4.2.2 Re-examinees

Normal	407
Silicosis early	4
Silicosis early with tuberculosis	—
Tuberculosis	—
Other conditions	—
Total	411

These men had previously been examined and some were in the industry prior to this examination.

4.3 Health Certificates Issued to New Applicants and Re-examinees

The following health certificates were issued under the Mines Regulation Act:—

Initial Certificates (Form 2)	4,663
Temporary Rejection Certificates (Form 3)	—
Rejection Certificates (Form 4)	9
Re-admission Certificates (Form 5)	11
Special Certificate (Form 9)	—
Total	4,683

5. Miners' Phthisis Act

The amount of compensation paid during the year was \$7,988.00 compared with \$9,712.00 for the previous year.

The number of beneficiaries under the Act as on 31/12/1972 was 37 being 3 ex miners and 34 widows.

6. Administrative

There were no administrative changes during the year.

A. L. DAY,
Superintendent, Mine Workers
Relief Act,
and
Chairman, Miners' Phthisis
Board

PERIODICAL EXAMINATION OF MINE WORKERS GRAPH Nº 1

SHOWING PERCENTAGES OF NORMALS AND EARLY SILICOTICS FROM 1945 ONWARDS

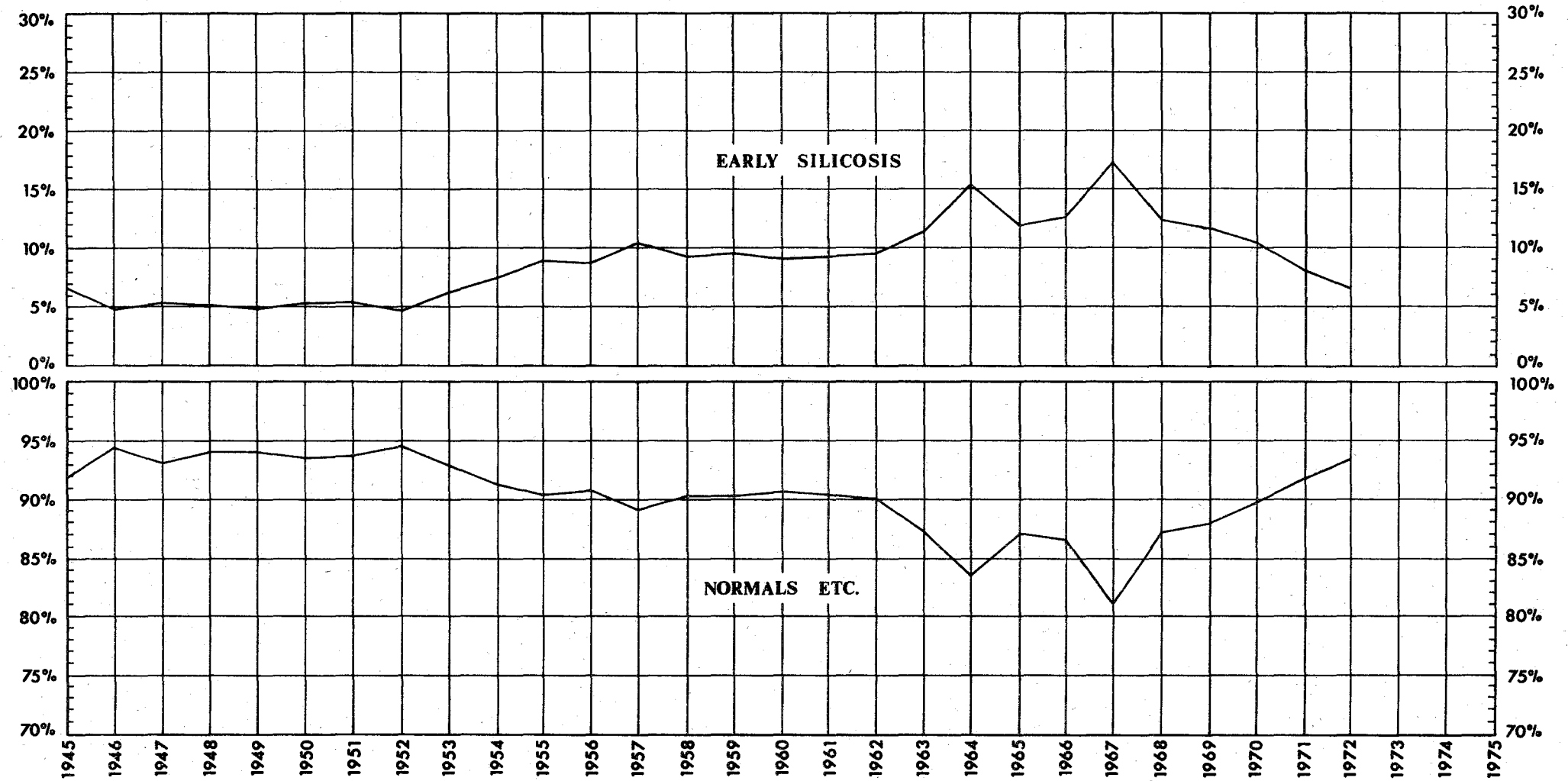

PERIODICAL EXAMINATION OF MINE WORKERS GRAPH N^o2

SHOWING PERCENTAGES OF SILICOSIS ADVANCED, SILICOSIS PLUS TUBERCULOSIS AND TUBERCULOSIS ONLY, FROM 1945 ONWARDS

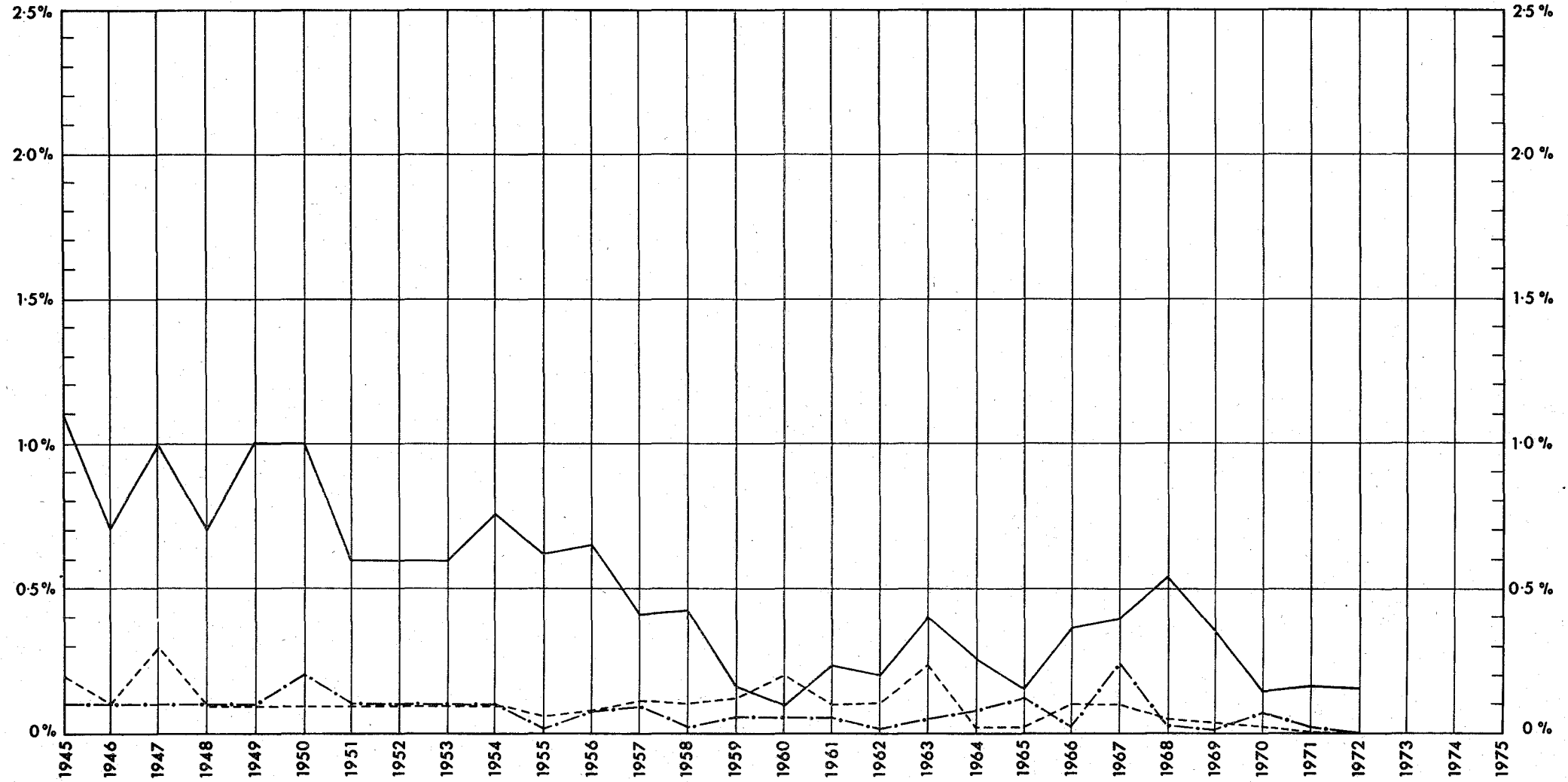

SILICOSIS ADVANCED ——— SILICOSIS PLUS TUBERCULOSIS - - - - - TUBERCULOSIS ONLY - · - · - ·

TABLE SHOWING RESULTS OF PERIODICAL EXAMINATION OF MINE WORKERS FROM INCEPTION OF EXAMINATIONS (1925)

Year	Normal		Silicosis Early		Silicosis Advanced		Silicosis plus Tuberculosis			Tuberculosis Only		Asbestosis						Total	Per Cent.	Total							
	Total	Per Cent.	Previously reported as Normal etc.	Previously reported as Silicosis Early	Total	Per Cent.	Previously reported as Normal etc.	Previously reported as Silicosis Early	Previously reported as Silicosis Advanced	Total	Per Cent.	Total	Per Cent.	Asbestosis early previously normal	Asbestosis early previously asbestosis early	Asbestosis advanced previously normal	Asbestosis advanced previously asbestosis early				Asbestosis advanced previously asbestosis advanced	Asbestosis plus tuberculosis previously normal	Asbestosis plus tuberculosis previously asbestosis				
1925	3,239	80.5	459	11.4	183	4.5	131	3.3	11	0.3	4,023
1926	3,116	83.6	33	348	381	10.2	85	93	2.5	27	62	123	3.4	10	0.3	3,728
1927	2,977	85.5	59	303	362	10.4	16	79	98	2.8	18	14	42	1.2	4	0.1	3,483
1928	2,120	81.9	102	224	326	12.6	34	60	94	3.6	8	14	41	1.6	7	0.3	2,588
1929	2,785	81.9	136	247	383	11.3	22	43	87	2.0	8	60	114	3.3	50	1.5	3,399
1930	2,530	84.0	94	252	346	11.5	18	35	53	1.8	4	35	58	1.9	3,012
1931	3,835	89.5	35	338	373	8.7	6	47	53	1.2	3	9	16	.4	4,285
1932	2,920	86.5	57	322	379	11.2	15	44	60	1.8	2	9	15	.4	3,377
1933	5,140	92.4	54	315	369	6.6	1	24	12	.7	6	6	12	.2	4,285
1934	4,437	92.3	35	303	338	7.0	24	2	.6	5	5	.1	3,377
1935	6,972	94.7	29	323	352	4.8	1	15	4	.3	3	8	11	.1	4,808
1936	7,487	95.4	15	319	334	4.3	14	4	.2	1	10	11	.1	5,563
1937	6,833	95.7	13	266	279	3.9	15	2	.2	1	8	17	.2	4,808
1938	6,670	95.6	18	264	282	4.0	7	3	.1	1	9	11	.1	7,363
1939	7,023	96.2	12	245	257	3.5	10	1	.2	40	7,852
1940	6,840	95.8	32	248	280	3.9	11	3	.20	7,141
1941	5,469	93.9	61	264	325	5.6	20	5	.4	20	6,975
1942	3,932	91.5	63	262	325	7.6	25	7	.7	51	7,299
1943	4,079	91.5	70	270	340	7.5	21	14	.8	71	7,141
1944	3,071	92.1	54	166	220	6.6	26	10	1.1	31	5,824
1945	5,294	94.4	89	172	261	4.7	36	2	.7	21	4,298
1946	6,021	93.3	101	237	338	5.2	49	9	1.0	133	4,468
1947	4,827	94.0	24	239	263	5.1	18	17	.7	11	3,334
1948	5,162	94.0	24	239	263	4.8	20	31	1.0	21	6,450
1949	5,077	93.6	14	269	283	5.2	14	41	1.0	11	5,134
1950	4,642	93.9	13	248	261	5.3	9	20	.9	41	5,489
1951	5,073	94.6	8	234	242	4.5	4	31	.6	21	4,942
1952	4,474	93.03	74	225	299	6.22	8	24	.61	5,359
1953	5,142	91.33	154	275	429	7.62	22	21	.43	61	4,809
1954	4,559	90.40	63	386	449	8.90	9	22	.31	11	5,630
1955	4,600	90.78	25	401	426	8.41	8	25	.33	11	5,043
1956	3,925	89.08	30	424	454	10.30	8	10	.18	412	5,067
1957	5,154	90.20	46	483	529	9.26	15	9	.24	610	4,406
1958	5,242	90.10	66	485	551	9.47	915	112	5,818
1959	5,214	90.54	50	473	523	9.08	509	219	5,759
1960	5,188	90.18	54	479	533	9.26	1323	309	5,753
1961	5,183	89.98	50	499	549	9.53	1019	110	5,760
1962	4,795	87.21	188	451	639	11.62	2240	724	4,498
1963	3,484	83.85	64	561	625	15.04	924	11	4,155
1964	3,770	87.39	53	459	512	11.87	614	102	4,314
1965	3,411	86.56	26	469	495	12.56	1436	310	3,941
1966	1,644	81.03	19	332	351	17.30	739	210	2,029
1967	3,364	86.93	39	431	470	12.14	1854	105	3,870
1968	3,406	87.77	36	412	448	11.55	1336	103	3,881
1969	3,841	89.73	30	400	430	10.04	614	102	4,281
1970	3,915	91.80	15	327	342	8.02	51602	4,265
1971	4,647	93.30	20	308	328	6.55	515	4,982

Segregation of asbestosis diagnoses commenced in 1959

MINING STATISTICS

to 31st December, 1972

Table of Contents

	Page
Table I.—Tonnage of Ore Treated and Yield of Gold and Silver, in fine ounces, reported to the Mines Department, from operating mines during 1972, and Total Production recorded to 31st December, 1972, from those mines	194
Table II.—Total Alluvial, Dollied and Specimen Gold, Tonnage of Ore Treated, Yield of Gold and Silver therefrom, reported to Mines Department from each respective Goldfield and District during 1972	200
Table III.—Total Production of Alluvial, Dollied and Specimen Gold, Tonnage of Ore Treated, Yield of Gold and Silver therefrom, since inception to 31st December, 1972	201
Table IV.—Total Output of Gold Bullion, Concentrates, etc., entered for Export, and received at the Perth Mint from 1st January, 1886	202

MINERALS OTHER THAN GOLD

Table V.—Quantity and Value of Minerals, other than Gold, as reported to the Mines Department during 1972	203
Table VI.—Total Mineral output of Western Australia, showing for each mineral, the progressive quantity produced and value thereof as reported to the Mines Department to 31st December, 1972	208
Table VII.—Showing average number of Men Employed above and underground in the larger mining companies operating in Western Australia during the Years 1971 and 1972	210

TABLE I

PRODUCTION OF GOLD AND SILVER AS REPORTED TO THE MINES DEPARTMENT DURING 1972.

(For details concerning Mines and Centres not listed see Annual Report for 1966 or previous Reports.)

(Note.—Lease numbers in brackets indicate that the holding was voided during the year.)

(Note.—* Denotes mainly derived from treatment of tailings. † Denotes mainly derived from Lead Ore. ‡ Denotes mainly derived from Copper Ore. § Concentrates.)

Mining Centre	Number of Lease	Registered Name of Company or Lease	Total for 1972					Total Production				
			Alluvial	Dolled and Specimens	Ore treated	Gold therefrom	Silver	Alluvial	Dolled and Specimens	Ore treated	Gold therefrom	Silver
			Fine ozs.	Fine ozs.	Tons (2,240 lb.)	Fine ozs.	Fine ozs.	Fine ozs.	Fine ozs.	Tons (2,240 lb.)	Fine ozs.	Fine ozs.
Pilbara Goldfield.												
MARBLE BAR DISTRICT.												
Bamboo Creek	G.M.L. 1118	Kitchener	620.00	721.46	1,755.50	2,191.01	3.53	
	1203	Mt. Prophecy	523.00	157.85	5,221.55	2,600.28	113.70	
	1255	Welcome	5.00	2.19	5.00	2.19	
194 Marble Bar	1092	Halley's Comet North Sundry Claims	35.00	8.90 3.33	67.08	255.30	21,873.79	8.90 12,932.57	10.96
North Pole	1254	Normay	564.00	119.29	669.00	145.36	
Warrawoona	(1315)	The Dawn State Battery, Marble Bar	10.00	16.76	10.00	16.76	
			*214.42	55.88	12.00	*14,894.94	531.23
Nullagine District												
Nullagine	Sundry Claims Banks and Gold Dealers	6.33	321.36	696.04	6,875.20	10,620.70	18.75
			3.92	10,129.20	147.52	48.03	6.12
Gascoyne Goldfield												
Mangaroon Station	G.M.L. 46	Star of Mangaroon	2.78	203.00	41.26	6.28	3,707.50	5,444.69	100.83
Peak Hill Goldfield.												
Peak Hill	Sundry Claims	47.74	61.51	478.19	35,365.35	9,030.99	5.35
East Murchison Goldfield.												
LAWLERS DISTRICT.												
Lawlers	G.M.L. 1400	Waroonga	1.62	19.30	1.62
	1352	Waroonga North	9.79	9.79
BLACK RANGE DISTRICT.												
Barrambie	G.M.L. 1117B	Scheelite Leases	140.00	101.34	1,667.00	1,050.73	19.60
Nungarra	Sundry Claims	128.00	5.33	50.27	1,458.98	7,825.40	2,971.70

Murchison Goldfield.

MEEKATHARRA DISTRICT.

Meekatharra	G.M.L. 2016N	Commodore	12-00	6-89				12-00	6-89		
	2068N	Halcyon	2,172-00	143-07				2,172-00	143-07		
	2062N	Havelock West	1,330-00	71-41				2,968-00	178-38		
	2070N	Grizzly's Reward	154-00	6-60				154-00	6-60		
	2071N	The Lucky Cut	200-00	7-60				200-00	7-60		
		Sundry Claims	52-00	1-24		279-84	1,392-22	32,651-46	11,762-09	13-10	
Yaloginda		Sundry Claims	10-00	5-38		61-89	647-51	11,753-67	5,125-04	1-02	

DAY DAWN DISTRICT.

Day Dawn		Sundry Claims	224-00	1-11		96-42	523-56	13,999-01	6,781-38	2-89	
----------	--	---------------	--------	------	--	-------	--------	-----------	----------	------	--

MOUNT MAGNET DISTRICT.

Jumbulyer		Sundry Claims	8-75	21-99		20-32	116-27	1,225-45	908-46		
Mt. Magnet	G.M.L. 1282N, etc.	Hill 50 Gold Mine N.L.	78,857-00	25,291-67	1,876-08			3,089,480-40	1,333,086-69	67,464-48	

YALGOO GOLDFIELD.

195

Goodingnow	G.M.L. 1063	Ark	205-00	38-94			12-49	2,613-50	2,007-86		
	1244	Sweet William Extended	12-00	2-40				30-00	3-40		
	1243	Threybit	100-00	3-04				602-00	32-35		
Noongal		Sundry Claims	3-75	14-80		39-32	340-42	8,510-30	3,984-89	1-16	

Mt. Margaret Goldfield.

MOUNT MALCOLM DISTRICT.

Diorite	G.M.L. (1908C)	Jasper Hills	60-00	10-12				187-75	49-64		
	1905C	King of the Hills	84-00	2-39			14-83	84-00	2-39		
	1974C	Puzzle	24-50	7-26				24-50	7-26		
Lake Darlot	1978C	Weebo Gold Mine	48-00	3-37				48-00	3-37		
		Sundry Claims	615-00	17-34		129-92	914-83	13,647-87	7,036-60	45-18	
Leonora	G.M.L. 1897C	Bon Boo	282-00	79-93				1,420-55	631-39		
	1906C	Sons of Gwalia	346-00	114-71				457-75	171-74		
	1762C, etc.	Sons of Gwalia Ltd.	133-50	103-22	2-48		21-21	7,031,784-53	2,581,728-85	188,812-19	
	1860C	W.A. Gold Development N.L.	973-00	90-93				973-00	90-93		
		Sundry Claims	15-32	91-32		37-73	392-58	23,988-95	13,150-87	26-77	
Mertondale		Sundry Claims	270-75	14-20		5-42	85-74	3,662-16	2,335-84	-87	
		State Battery, Leonora		*679-47				91-00	*1,364-78	37-75	

Table I.—Production of Gold and Silver from all sources, etc.—continued.

Mining Centre	Number of Lease	Registered Name of Company or Lease	Total for 1972					Total Production				
			Alluvial	Dollied and Specimens	Ore treated	Gold therefrom	Silver	Alluvial	Dollied and Specimens	Ore treated	Gold therefrom	Silver
			Fine ozs.	Fine ozs.	Tons (2,240 lb.)	Fine ozs.	Fine ozs.	Fine ozs.	Fine ozs.	Tons (2,240 lb.)	Fine ozs.	Fine ozs.
North Coolgardie Goldfield.												
MENZIES DISTRICT.												
Menzies	G.M.L. 5799Z 5804Z	First Hit Gladys Mary			22·00 10·75	2·29 2·24			830·00 600·00	164·29 26·72		
Mt. Ida	5787Z 5701Z, etc.	Lake View & Star Ltd. Lake View & Star Ltd. Prior to transfer to present holders Sundry Claims			570·50 320·50 6·72	414·51 132·75			570·50 421·00 487,579·36 16,195·11	414·51 182·78 248,250·96 8,284·32	3·22 8,505·69 ·12	
ULARRING DISTRICT.												
Mulwarrie	G.M.L. 1113U	Oakley Gold and Scheelite Synd. L.T.T. 1U/66 (1639H)				293·93 1·81			5,612·00	9,089·45 1·81	333·95	
NIAGARA DISTRICT.												
Kookynie		Sundry Claims			1·74	334·00	37·91	60·92	108·34	9,936·30	7,038·25	4·19
YERILLA DISTRICT.												
Yarri	G.M.L. (1347R) 1126R, etc.	Dawn Porphyry (1939) G.M.N.L. Prior to transfer to present holders Sundry Claims			14·00 469·00 71·00	1·83 73·79 20·53			212·50 68,474·00 30,344·50 18,499·05	30·85 10,082·05 5,448·82 6,420·36	261·95 507·51 1·40	
Broad Arrow Goldfield.												
Bardoo		Sundry Claims			385·00	10·26		54·95	1,218·09	19,366·18	8,599·26	
Black Flag		Sundry Claims			26·34	7·00	7·65	712·92	277·93	8,406·66	5,034·79	
Broad Arrow	G.M.L. 2341W	Chancelot Sundry Claims			204·00 10·96	18·10		1,008·56	3,177·54	753·00 40,950·15	43·30 17,821·78	1·42
Grants Patch	2311W	Bent Tree Sundry Claims			47·00 19·01	13·21		4·42	375·67	212·00 7,829·62	147·81 3,402·86	4·28
Ora Banda	2270W, 2290W	Gimlet South Leases			4,802·00	290·02				53,165·00	6,082·99	164·62
Paddington	2298W	Rona Lucille			57·50	42·56				1,219·75	897·77	17·97
Riches Find	2358W	Pole			2·70				2·70	96·00	19·53	

North-East Coolgardie Goldfield.

KANOWNA DISTRICT.

Gindalbie	G.M.L. 1594X	Binti Binti Sundry Claims	80-50 11-75	29-69 4-14						123-50 5,935-77	37-15 3,323-83		
Kalpini	1598X 1599X	Kalpini Enterprise Kalpini Main Lode	72-75 1,276-00	14-08 194-59						72-75 1,554-25	14-08 223-85		

East Coolgardie Goldfield.

EAST COOLGARDIE DISTRICT.

Binduli	G.M.L. 6703E	Royal Standard South	81-00	3-78						81-00	3-78			
Boorara	6671E	Waterfall North	161-50	95-08						302-50	216-43			
Boulder	5695E, etc. 5345E, etc. 5708E, etc. 5431E, etc. 5405E, etc.	Great Boulder Prop. Gold Mines Ltd. Gold Mines of Kalgoorlie (Aust.) Ltd. Prior to transfer to present holders Lake View & Star Ltd. Prior to transfer to present holders North Kalgurli (1912) Ltd. North Kalgurli (1912) Ltd. (Croesus Pty. Ltd.) Prior to transfer to present holders	132,492-00 397,496-00 158,753-00	28,904-59 81,600-37 26,474-72	17-94 29,501-46 9,960-66 24,679-21					1-53 849-95 8-49 127-55	16,772,306-97 6,418,503-75 15,916,923-07 22,728,974-30 15,792,500-38 9,669,818-24	7,054,899-59 1,620,740-23 6,416,710-17 6,308,006-47 9,149,223-80 2,366,374-86	1,885,182-30 524,140-49 819,123-27 711,051-94 1,348,055-82 720,952-60	
Feysville		Sundry Claims	5-00	1-82						199-00	1,485-25	675-83		
197 Hampton Plains	P.P.L. 277, Loc. 50	Lake View & Star Ltd. (Pernatty) Prior to transfer to present holders	4,990-00	848-57							32,529-00	3,024-44		
Kalgoorlie	G.M.L. 6678E 6692E 6563E, etc. 6485E 6615E 6639E	Domeyer Golden Pennies Gold Mines of Kalgoorlie (Aust.) Ltd. (Mt. Charlotte) Prior to transfer to present holders Maritana Hill Middle Hannans Old Hinchcliffe Sundry Claims	51-25 30-00 677,364-00 1,571-25 917-50 345-50 69-50	11-99 12-28 114,936-00 91-52 219-20 25-66 1-77							51-25 30-00 4,355,353-00 85,723-60 6,250-75 3,226-50 1,774-25 64,092-37	11-99 12-28 629,714-05 18,167-21 654-20 712-64 198-48 23,498-85		2-06 171-56 20
Wombola	5497E 5500E 5497E 5500E 5689E, etc. 6635E 6614E 6676E 6707E	Daisy Leases Daisy Happy-Go-Lucky Haoma Leases Prior to transfer to present holders Hodad Logan's Gold Mine Rosemary Sobers Sundry Claims State Battery, Kalgoorlie F. E. Regan—L.T.T. 26/30 (1953H)	702-25 73-00 112-50 3,724-50 255-50 147-25 456-00 5-00	999-49 7-57 56-91 745-89 194-21 17-28 319-58 *357-91 12-52							25,992-20 6,282-25 2,075-25 7,502-50 60,201-00 3,625-00 4,924-75 366-25 147-25 27,395-18 390-70 5-00	25,196-69 5,031-93 1,675-85 7,896-68 57,932-14 559-99 942-41 229-17 17-28 15,804-89 *41,723-34 12-52	884-76 1,011-58 827-18 51-81 1-25 20 739-51	

BULONG DISTRICT.

Balagundi		Sundry Claims	30-88	67-00	37-08			3-51	326-60	883-26	545-78		
-----------	--	---------------	-------	-------	-------	--	--	------	--------	--------	--------	--	--

Table I.—Production of Gold and Silver from all sources, etc.—continued.

Mining Centre	Number of Lease	Registered Name of Company or Lease	Total for 1972					Total Production				
			Alluvial	Dollied and Specimens	Ore treated	Gold therefrom	Silver	Alluvial	Dollied and Specimens	Ore treated	Gold therefrom	Silver
			Fine ozs.	Fine ozs.	Tons (2,240 lb.)	Fine ozs.	Fine ozs.	Fine ozs.	Fine ozs.	Tons (2,240 lb.)	Fine ozs.	Fine ozs.
Coolgardie Goldfield.												
COOLGARDIE DISTRICT.												
Bonnievale	G.M.L. 6151	Melva Maie		1.18	292.00	33.75			1.18	619.00	70.33	
	5890	Rayjax			45.50	125.57				1,182.25	1,640.68	5.12
Bulla Bulling	6003	Worked Out			11.00	21.65				194.00	223.51	
Burbanks	6069	New Lord Bobs			24.50	14.94				123.00	40.12	
	6018	Stephen Frederick			42.00	1.13				42.00	1.13	
		Sundry Claims			20.50	11.02		55.05	497.55	18,260.35	9,489.61	.93
Coolgardie	G.M.L. 6167	Fly Tox		5.04	154.00	75.78			5.04	358.00	284.73	
	5844	Jackpot			32.00	2.50				10,373.75	4,301.10	
	6176	Three Mile			727.00	42.29				727.00	42.29	
	6158	Tindals East			10.00	5.78				29.00	9.56	
	6175	Yellow Belle			375.50	10.97				375.50	10.97	
		Sundry Claims			422.50	44.11		236.14	3,044.77	90,724.44	30,238.01	1.90
Gibraltar	5723	Lloyd George		3.55	98.00	9.69			3.55	861.00	186.47	
		Sundry Claims			102.00	5.78		1.39	50.76	3,693.60	1,452.19	
Gnarlbine	(6177)	Gnarlbine			248.00	6.49				248.00	6.49	
Higginsville	5647	Fair Play Gold Mine			600.50	33.70		4.42	62.70	29,420.25	3,291.15	.02
	6106	Liberator			221.00	114.81				221.00	114.81	
	6061	Two Boys		175.02	259.00	422.28			291.73	1,209.25	697.08	
Larkinville		Sundry Claims			9.00	7.86			147.20	537.28	1,124.36	
Logans	6157	Westmin			108.00	9.15				108.00	9.15	
Londonderry		Sundry Claims			30.00	1.87		16.68	80.78	4,306.42	2,697.46	22.42
Ryans Find	5999	Consolidated Gold Mining Areas N.L.			1,021.00	754.89				1,098.00	800.04	
		Prior to transfer to present holders							3,126.84	241.75	2,469.56	
KUNANALLING DISTRICT.												
Carbine		Sundry Claims			30.75	16.59		136.27	96.96	6,814.88	2,411.35	
Dunnsville		Sundry Claims			59.50	6.89		21.00	1,034.08	3,130.46	2,124.21	
Kintore	G.M.L. 1059S	New Haven			1,298.00	196.45				1,298.00	196.45	
		Sundry Claims			318.50	6.32		111.91	102.70	5,817.28	2,715.75	
Kunanalling	1052S	Catherwood			70.00	4.77				485.75	34.57	

Yilgarn Goldfield.

Bullfinch	G.M.L. 4535	Casas	363.00	153.11					447.75	210.54	2.21
		Sundry Claims	94.75	11.51		8.47	45.49	7,788.89	4,306.18	24.27	
Eenuin	4540	North End	40.00	8.18				95.00	15.66	.20	
Golden Valley	4427	W.A. Gold Development N.L. Prior to transfer to present holders	107.25	164.82				3,636.35 46,599.80	1,276.60 66,913.71	45.02 2,004.72	
Marvel Loch	4522	Brindisi	257.75	18.84				257.75	18.84		
	4657	Bronco Links	84.75	1.92				84.75	1.92		
	3724	Frances Firness	750.75	32.27			591.90	24,706.75	10,558.59	306.81	
	(4618)	Mary Lena	1,503.00	184.09				2,270.00	468.72		
Parkers Range	4508	Buffalo	79.75	8.42			10.36	1,355.75	241.87	5.62	
	4670	Garibaldi	110.25	17.33				110.25	17.33		
	4621	The Dollar	94.50	30.60				124.75	42.48		
		Sundry Claims	185.25	27.38		6.59	303.93	14,378.55	5,713.61	3.24	
Southern Cross	4634	Frasers	1,290.50	333.92				1,290.50	333.92		
		State Battery, Marvel Loch		*348.72		.44		147.00	*5,241.18	2,649.89	

Dundas Goldfield.

Beete	G.M.L. 2044	Beete	18.00		3.00		196.30	82.00	156.57	54.98	
Dundas	2054	Abbotshall		182.00	24.45	.26		372.00	32.14	.44	
	2128	Maybe	3.35	10.00	1.36	.43	3.35	10.00	1.36	.43	
		Sundry Claims		30.00	12.22	2.95	.76	413.85	2,360.75	1,189.44	24.02
Norseman	1936, etc.	Central Norseman Gold Corporation N.L. Prior to transfer to present holders		145,484.00	47,082.36	32,364.13		5,120,422.20	2,339,093.15	1,611,137.54	
		Sundry Claims	.70	32.50	5.95	.25	1,052.25	1,663.32 3,621.89	69,819.83 49,908.95	47,892.08 22,657.20	16,508.85 245.10

Phillips River Goldfield.

Kundip	G.M.L. 277	Western Gem	93.00	80.88	.05			656.00	209.11	.05	
--------	------------	-------------	-------	-------	-----	--	--	--------	--------	-----	--

TABLE II

Production of Gold and Silver from all Sources, showing in fine ounces the output, as reported to the Mines Department during the year 1972.

Goldfield	District	District						Goldfield								
		Alluvial	Dolled and Specimens	Ore Treated	Gold Therefrom	Total Gold	Silver	Alluvial	Dolled and Specimens	Ore Treated	Gold Therefrom	Total Gold	Silver			
		Fine ozs.	Fine ozs.	Tons (2,240 lb.)	Fine ozs.	Fine ozs.	Fine ozs.	Fine ozs.	Fine ozs.	Tons (2,240 lb.)	Fine ozs.	Fine ozs.	Fine ozs.			
Kimberley			
West Kimberley			
West Pilbara			
Pilbara	Marble Bar	1,757.00	1,244.20	1,244.20	55.88	} 3.92	6.33	1,757.00	1,244.20	1,254.45	55.88			
	Nullagine	3.92	6.33	10.25		
Ashburton		
Gascoyne	2.78	203.00	41.26	44.04		
Peak Hill	47.74	47.74		
East Murchison	Lawlers	11.41	11.41		} 11.41	11.41	268.00	106.67	118.08		
	Wiluna	
	Black Range	268.00	106.67	106.67	
	Cue	
Murchison	Meekatharra	3,930.00	242.19	242.19			} 83,019.75	83,019.75	25,556.96	25,556.96	1,876.08	
	Day Dawn	224.00	1.11	1.11	
	Mt. Magnet	78,865.75	25,313.66	25,313.66	1,876.08	
Yalgoo			320.75	59.18	59.18	
Mt. Margaret	Mt. Morgans	} 17.80			17.80	2,989.75	1,214.26	1,232.06	5.87	
	Mt. Malcolm	17.80	2,989.75	1,214.26	1,232.06
	Mt. Margaret	
North Coolgardie	Menzies	6.72	923.75	551.79	558.51		} 8.46		8.46	1,811.75	981.59	990.05	
	Ularring	295.74	295.74
	Niagara	1.74	334.00	37.91	39.65
	Yerilla	554.00	96.15	96.15	
Broad Arrow			} 59.01	59.01	5,502.50	381.80	440.81	
North-East Coolgardie	Kanowna	1,441.00	242.50	242.50	1,441.00	242.50	242.50
	Kurnalpi
East Coolgardie	East Coolgardie	1,379,803.50	256,074.97	256,074.97	64,197.48	} 30.88			30.88	1,379,870.50	256,112.05	256,142.93	64,197.48	
	Bulong	30.88	67.00	37.08	67.96
Coolgardie	Coolgardie	184.79	4,853.00	1,756.01	1,940.80				} 184.79	184.79	6,629.75	1,987.03	2,171.82
	Kunanalling	1,776.75	231.02	231.02
Yilgarn	4,961.50	1,341.11	1,341.11
Dundas		} 22.05			22.05	145,738.50	47,126.34	47,148.39	32,371.02
Phillips River	93.00	80.88	80.88
South-West Mineral Field
Northampton Mineral Field
State Generally
Outside Proclaimed Goldfield	
Total	3.92		391.25		1,634,606.75	336,475.83	336,871.00	98,506.82	

TABLE III

Return showing total production reported to the Mines Department, and respective Districts and Goldfields from whence derived, to 31st December, 1972.

Goldfield	District	District						Goldfield					
		Alluvial	Dollied and Specimens	Ore Treated	Gold Therefrom	Total Gold	Silver	Alluvial	Dollied and Specimens	Ore Treated	Gold Therefrom	Total Gold	Silver
		Fine ozs.	Fine ozs.	Tons (2,240 lb.)	Fine ozs.	Fine ozs.	Fine ozs.	Fine ozs.	Fine ozs.	Tons (2,240 lb.)	Fine ozs.	Fine ozs.	Fine ozs.
Kimberley								1.30	24.68	1.00	2.49	28.47	37,317.55
West Kimberley								9,086.26	3,035.43	22,931.90	17,292.01	29,413.70	128.76
West Pilbara								6,359.08	374.74	24,900.96	24,379.30	31,113.12	1,910.66
Pilbara	Marble Bar	15,530.82	4,581.71	351,766.27	338,258.29	358,370.82	33,476.39	26,044.27	7,497.73	502,017.94	473,765.49	507,307.49	34,557.31
	Nullagine	10,513.45	2,916.02	150,251.67	135,507.20	148,936.67	1,080.92						
Ashburton								9,268.52	482.46	6,807.10	2,913.43	12,664.41	41,971.38
Gascoyne								698.49	124.11	4,191.50	6,340.66	7,163.26	127.75
Peak Hill								3,387.79	5,482.62	783,070.73	322,738.34	331,608.75	3,794.07
East Murchison	Lawlers	7,122.81	2,373.46	2,022,688.17	827,881.22	837,377.49	27,268.77	9,032.39	22,237.54	12,629,277.08	3,656,031.06	3,687,300.99	60,324.41
	Wiluna	236.48	1,254.11	8,873,653.69	1,872,323.07	1,873,813.66	10,322.32						
	Black Range	1,673.10	18,609.97	1,732,935.22	955,826.77	976,109.84	22,733.32						
Murchison	Cue	5,145.34	9,109.95	6,815,630.31	1,403,613.40	1,417,868.69	274,844.04	25,789.49	59,689.54	15,443,330.18	6,046,647.13	6,132,126.16	523,898.40
	Meekatharra	14,705.91	18,758.87	2,338,099.57	1,312,336.01	1,345,800.79	5,278.85						
	Day Dawn	3,291.61	11,341.80	2,037,934.13	1,375,649.34	1,390,282.75	169,447.42						
Mt. Magnet		2,646.63	20,478.92	4,251,666.17	1,955,048.38	1,978,173.93	74,328.09	1,815.77	3,263.38	445,280.83	264,452.49	269,531.64	1,523.06
Yalgoo	Mt. Morgans	3,574.87	9,401.98	1,218,186.31	718,019.63	730,996.48	5,831.33	11,790.63	35,484.99	11,509,205.07	4,968,603.03	5,015,878.65	262,849.79
	Mt. Malcolm	4,067.66	16,728.66	7,762,345.52	3,076,539.84	3,097,336.16	190,827.76						
	Mt. Margaret	4,148.10	9,354.35	2,528,173.24	1,174,043.56	1,187,546.01	66,190.70						
North Coolgardie	Menzies	1,696.69	7,046.43	1,955,759.98	1,434,629.89	1,443,373.01	39,179.65	4,858.70	19,986.59	3,739,453.23	2,590,063.30	2,614,908.59	72,529.03
	Ularring	129.66	7,299.53	539,222.45	447,865.82	455,295.01	22,286.97						
	Niagara	1,718.48	1,823.51	944,859.02	528,643.14	532,185.13	5,716.17						
Yerilla		1,313.87	3,817.12	299,611.78	178,924.45	184,055.44	5,346.24	22,002.94	28,211.95	1,426,718.74	755,766.80	805,981.69	5,703.32
Broad Arrow													
North-East Coolgardie	Kanowna	106,549.25	13,635.61	1,039,482.86	631,596.01	751,780.87	3,051.22	119,386.73	21,942.62	1,054,321.68	650,841.69	792,171.04	3,063.93
	Kurnalpi	12,837.48	8,307.01	14,838.82	19,245.68	40,390.17	12.71						
East Coolgardie	East Coolgardie	33,741.51	41,472.41	100,313,324.74	38,923,332.26	38,998,546.18	6,555,281.50	61,147.04	57,540.06	100,502,370.29	39,056,642.60	39,175,329.70	6,555,381.26
	Bulong	27,405.53	16,067.65	189,045.55	133,310.34	176,783.52	99.76						
Coolgardie	Coolgardie	17,212.95	22,339.10	3,023,607.97	1,550,783.72	1,590,335.77	54,478.99	18,734.84	28,222.92	3,393,779.67	1,805,049.41	1,852,007.17	55,252.05
	Kunanalling	1,521.89	5,883.82	370,171.70	254,265.69	261,671.40	773.06						
Yilgarn								2,198.76	6,414.14	8,305,729.72	2,448,716.67	2,457,329.57	216,511.60
Dundas								2,256.21	16,698.55	7,167,496.12	3,311,980.79	3,330,935.55	2,029,164.48
Phillips River								607.11	823.32	131,315.24	125,867.32	127,297.75	81,021.04
South-West Mineral Field								313.08	48.66	4,938.33	2,522.24	2,883.98	15.18
Northampton Mineral Field													5,286.31
State Generally								1,200.86	1,111.85	27.00	10,203.49	12,516.20	32,662.66
Outside Proclaimed Goldfield													1,259.58
Total								335,980.26	318,697.88	167,097,164.31	66,540,819.74	67,195,497.88	10,026,253.58

201

TABLE IV

Total output of Gold Bullion, Concentrates, etc., entered for export and received at the Perth Mint from 1st January, 1886.

Year	Export	Mint	Total	Estimated Value
	Fine ozs.	Fine ozs.	Fine ozs.	\$A
1886	270.17	270.17	2,204
1887	4,359.37	4,359.37	37,036
1888	3,124.82	3,124.82	26,546
1889	13,859.52	13,859.52	117,742
1890	20,402.42	20,402.42	173,323
1891	27,116.14	27,116.14	230,364
1892	53,271.65	53,271.65	452,568
1893	99,202.50	99,202.50	842,770
1894	185,298.73	185,298.73	1,574,198
1895	207,110.20	207,110.20	1,759,498
1896	251,618.69	251,618.69	2,137,616
1897	603,846.44	603,846.44	5,129,954
1898	939,489.49	939,489.49	7,981,394
1899	1,285,380.25	187,244.41	1,470,604.66	12,493,464
1900	894,387.27	519,923.59	1,414,310.86	12,015,220
1901	925,695.96	779,729.56	1,703,416.52	14,471,308
1902	707,039.75	1,163,937.80	1,871,037.55	15,895,322
1903	835,665.78	1,231,115.62	2,064,801.40	17,541,438
1904	810,618.04	1,172,614.03	1,983,230.07	16,848,452
1905	655,989.98	1,300,226.00	1,955,315.88	16,611,308
1906	562,250.59	1,232,226.01	1,794,546.60	15,245,498
1907	431,303.14	1,265,750.45	1,697,553.59	14,421,500
1908	356,353.96	1,291,557.17	1,647,911.13	13,999,762
1909	386,370.58	1,208,898.83	1,595,269.41	13,552,548
1910	293,970.34	1,236,661.68	1,470,632.02	12,493,696
1911	180,422.28	1,210,445.24	1,370,867.52	11,646,150
1912	83,577.12	1,199,080.87	1,282,657.99	10,896,770
1913	86,255.13	1,227,788.15	1,314,043.28	11,163,402
1914	51,454.65	1,181,522.17	1,232,976.82	10,474,704
1915	17,340.47	1,192,771.23	1,210,111.70	10,280,456
1916	26,742.17	1,084,655.87	1,061,398.04	9,017,064
1917	9,022.49	961,294.67	970,317.16	8,243,292
1918	15,844.12	880,867.03	876,511.15	7,446,366
1919	6,445.69	727,619.90	734,065.59	7,237,018
1920	5,261.13	612,581.00	617,842.13	7,197,862
1921	7,170.74	546,559.92	553,730.66	5,885,052
1922	5,320.16	532,926.12	538,246.28	5,051,624
1923	5,933.82	498,577.59	504,511.41	4,464,372
1924	2,585.20	482,449.78	485,034.98	4,511,854
1925	3,910.59	437,341.56	441,252.15	3,748,640
1926	3,188.22	434,154.98	437,343.20	3,715,430
1927	3,359.10	404,993.41	408,352.51	3,469,144
1928	3,339.30	390,069.19	393,408.49	3,342,186
1929	3,087.12	374,138.96	377,176.08	3,204,284
1930	1,753.09	415,765.00	417,518.09	3,728,884
1931	1,726.66	508,845.36	510,572.02	5,996,274
1932	3,887.07	601,674.33	605,561.40	8,807,284
1933	2,446.97	634,760.40	637,207.37	9,772,508
1934	3,520.40	647,817.95	651,338.35	11,117,746
1935	9,868.71	639,180.38	649,049.09	11,404,293
1936	55,024.58	791,183.21	846,207.79	14,747,073
1937	71,646.91	928,999.84	1,000,646.75	17,487,510
1938	113,620.06	1,054,171.13	1,167,791.19	20,726,046
1939	98,739.88	1,115,497.76	1,214,237.64	23,685,928
1940	71,680.47	1,119,801.08	1,191,481.55	25,393,006
1941	65,925.94	1,043,391.96	1,109,317.90	23,702,890
1942	15,676.48	882,503.97	848,180.45	17,730,990
1943	6,403.34	540,067.08	546,470.42	11,421,338
1944	1,824.99	464,439.76	466,264.75	9,799,994
1945	5,029.38	463,521.34	468,550.72	10,021,082
1946	6,090.14	610,873.52	616,963.66	13,280,138
1947	5,220.09	698,366.29	703,586.38	15,151,148
1948	4,653.72	660,332.07	664,985.79	14,313,818
1949	4,173.14	644,252.48	648,425.62	15,925,616
1950	4,161.53	606,171.88	610,333.41	18,932,540
1951	5,589.45	622,189.64	627,779.09	19,450,686
1952	9,608.62	720,366.44	729,975.06	23,695,834
1953	5,396.30	818,515.65	823,911.95	26,598,184
1954	3,089.08	847,451.09	850,540.17	26,627,236
1955	4,091.51	837,913.72	842,005.23	26,351,118
1956	2,331.10	810,048.68	812,379.78	25,411,162
1957	2,042.27	894,638.71	896,680.98	28,076,370
1958	1,810.69	865,376.80	867,187.49	27,109,868
1959	2,321.99	864,286.87	866,608.86	27,033,858
1960	2,068.66	853,690.02	855,758.68	26,748,322
1961	2,942.58	868,902.39	871,844.97	27,413,780
1962	4,539.02	854,829.13	859,368.20	26,871,460
1963	4,663.37	795,546.34	800,211.71	25,035,372
1964	3,070.91	709,776.09	712,847.00	22,299,866
1965	2,986.66	656,440.42	659,427.08	20,722,164
1966	1,462.05	627,314.65	628,776.70	19,765,287
1967	2,743.28	573,277.73	576,021.01	18,071,924
1968	913.26	510,734.17	511,703.03	16,735,723
1969	1,413.06	463,998.56	465,411.62	17,707,219
1970	1,578.25	340,029.82	341,608.07	11,069,049
1971	988.24	347,071.08	348,059.32	11,921,570
1972	343,851.74	348,851.74	16,042,688
	11,606,290.78	57,153,069.17	68,759,359.95	\$1,121,050,370

Estimated Mint value of above production	1971 \$A 1,091,212,847	1972 \$A 1,103,462,894
Overseas Gold Sales Premium distributed by Gold Producers Association, 1920-1924	5,179,204	5,179,204
Overseas Gold Sales Premium distributed by Gold Producers Association from 1952	8,615,631	13,774,877
Estimated Total	\$A1,105,007,682	\$A1,122,416,975
Bonus paid by Commonwealth Government under Commonwealth Bounty Act, 1930	322,896	322,896
Subsidy paid by Commonwealth Government under Gold Mining Industry Assistance Act, 1954, from 1955	23,086,614	29,169,983
Gross estimated value of gold won	\$A1,133,417,192	\$A1,151,909,764

TABLE V

Quantity and Value of Minerals, other than Gold, Reported during the year 1972

Number of Lease, Claim or Area	Goldfield or Mineral Field	Registered Name of Producer	Quantity Long Tons	Metallic Content	Value \$A
ALUMINA					
M.L. 1SA	South-West	Alcoa of Australia (W.A.) Ltd.	1,184,484.00	75,806,800.00
M.L. 1SA	South-West	Alcoa of Australia (W.A.) Ltd.	228,693.00	14,636,600.00
			1,413,182.00	90,443,400.00 (l)
BERYL (g) (h)					
M.C. 874	Yalgoo	Seleka Mining & Investments Ltd.	61.49	Be O Units 733.30	(b) 12,870.39
BUILDING STONE (Quartzite)					
M.C. 1158H, etc.	South-West	House, R. P.	1,091.00	(c) 4,410.00
BUILDING STONE (Quartz)					
M.C. 2110H	South-West	Snowstone Pty. Ltd.	3,781.00	37,810.00 (a) (b)
BUILDING STONE (Quartz Crystal)					
M.C. 2110H	South-West	Snowstone Pty. Ltd.	210.00	(c) 3,192.00
BUILDING STONE (Granite-facing stone)					
M.C. 719H	South-West	Crawford Quarries Pty. Ltd.	60.00	(c) 5,400.00
BUILDING STONE (Spongolite)					
M.C. 1062H	South-West	Worth, H.	90.50	(a) (c) 1,267.00
CLAYS (Bentonite)					
M.C. 1042H, etc.	South-West	Scott, M. E., W. T. and R. J.	162.00	(a) 2,322.00
CLAYS* (Brick Pipe and Tile Clay)					
M.C. 1438H	South-West	Hawker Siddeley Building Supplies Pty. Ltd.	10,214.00	10,214.00
M.C. 1438H	South-West	Concrete Industries (Monier) Ltd.	9,792.00	9,792.00
Private Property	South-West	Swaby, F. W.	53,000.00	132,500.00
	South-West	† Unspecified Producers	49,330.00	26,145.00
			122,336.00	(c) 178,651.00
CLAYS (Cement Clay)					
M.C. 788H	South-West	Bell Bros. Pty. Ltd.	31,548.00	88,134.40
M.C. 1018H	South-West	Swan Portland Cement Ltd.	712.95	1,768.11
			32,260.95	(c) 89,902.51
CLAYS (Fireclay)					
M.C. 1302H	South-West	Bridge, J. S.	25,327.00	25,327.00
M.C. 522H, 523H	South-West	Bridge, J. S. & T. D.	36,160.00	36,160.00
M.C. 304H, etc.	South-West	Clackline Refractories Ltd.	1,000.00	2,000.00
M.C. 436H	South-West	Midland Brick Co. Pty. Ltd.	92,566.00	38,711.50
M.C. 435H	South-West	Midland Brick Co. Pty. Ltd.	14,288.00	4,981.75
			169,341.00	(c) 107,180.25
CLAYS (White Clay-Ball Clay)					
M.C. 109H	South-West	H. L. Brisbane & Wunderlich Ltd.	901.00	(c) 10,812.00
* Incomplete. † From private property not held under the Mining Act.					
COAL					
C.M.L. 448, etc.	Collie	Griffin Coal Mining Co. Ltd.	607,676.80	2,556,436.78
C.M.L. 437, etc.	Collie	Western Collieries Ltd.	541,423.90	3,350,725.51
			1,149,100.70	5,907,162.29 (e)
COBALT (Metallic By-Product Nickel Mining)					
M.L. 150, etc.	Coolgardie	Western Mining Corporation Ltd.	Cobalt Tons 145.47	452,100.00
M.C. 39W	Broad Arrow	Great Boulder Mines Limited and North Kalgurli Mines Ltd.	45.01	177,400.00
			190.48	(f) 629,500.00

TABLE V.—Quantity and Value of Minerals, other than Gold, Reported during the Year 1972—continued

Number of Lease, Claim or Area	Goldfield or Mineral Field	Registered Name of Producer	Quantity Long Tons	Metallic Content	Value \$A
COPPER (Metallic By-Product Nickel Mining)					
M.L. 150	Coolgardie	Western Mining Corporation Ltd.		Copper Tons 713·16	(f) 632,400·00
COPPER ORE AND CONCENTRATES (g) (h)					
M.C. 97P	Peak Hill	Group Explorations Pty. Ltd.	999·69	Copper Units 30,650·61	(a) 254,990·00
FELSPAR					
M.L. 80, etc.	Coolgardie	Australian Glass Manufacturers Co. Pty. Ltd.	560·50		(a) 8,407·50
GLASS SAND					
M.C. 365H	South-West	Leach, R. J.	20·00		30·00
M.C. 1827H	South-West	Oma, R. C.	369·00		2,587·00
M.C. 417H	South-West	Australian Glass Manufacturers	12,861·15		17,362·83
M.C. 521H	South-West	Bell Bros.	5,828·00		15,472·00
M.C. 1074H	South-West	Ready Mix Group (W.A.)	1,031·00		N.A.
M.C. 1191H	South-West	Silicon Quarries Pty. Ltd.	142,117·00		90,761·00
M.C. 619H, 620H	South-West	Westralian Sands Limited	536·00		1,664·00
			162,762·15		(c) 127,876·83
GYPSUM					
M.C. 30, etc.	Yilgarn	Ajax Plaster Co. Pty. Ltd.	18,509·00		37,042·00
M.C. 9, etc.	Yilgarn	West Australian Plaster Mills	21,328·66		46,050·19
M.C. 50, etc.	Yilgarn	H. B. Brady & Co. Pty. Ltd.	16,112·00		40,280·00
M.C. 43, etc.	Gascoyne	Garrick Agnew Pty. Ltd.	73,748·00		258,118·00
M.C. 485H	South-West	Swan Portland Cement	1,694·50		4,369·18
M.C. 1115H, etc.	South-West	McAndrew, R. W.	50·00		95·00
M.C. 712H	South-West	Gypsum Industries of Aust. Pty. Ltd.	242·00		484·00
			131,684·16		(a) 386,438·37
Plaster of Paris reported as manufactured during the year being 30,731 tons from 43,648 tons of Gypsum by four Companies.					
Gypsum used in the manufacture of cement = 14,061·50 tons.					
IRON ORE (Pig Iron)					
T.R. 1258H	Yilgarn	Charcoal Iron and Steel Industry	Ore Treated Tons 98,113·00	Pig Iron Recovered Tons 60,829·00	3,987,937·00 (c) (d)
IRON ORE (Ore Railed to Kwinana)					
M.L. 2SA	Yilgarn	Dampier Mining Co. Ltd.	*1,551,356·00	Av. Assay Fe % 63·00	11,612,943·00 (n)
* Includes 647,200 W.L. Tons shipped to Eastern States.					
IRON ORE (Ore Shipped to Eastern States)					
M.L. 10, etc.	West Kimberley	Dampier Mining Co. Ltd.	980,920·00	66·04	7,334,901·00
M.L. 50/60	West Kimberley	Dampier Mining Co. Ltd.	66,923·00	65·70	(n)
M.L. 244SA	Peak Hill	Mt. Newman Mining Co. Pty. Ltd.	1,938,863·00	64·00	12,939,223·00 (b)
			2,986,706·00		20,274,124·00
IRON ORE (Ore Exported Overseas)					
M.L. 50/60	West Kimberley	Dampier Mining Co. Ltd.	1,572,250·00	66·42	9,981,858·00 (b)
M.L. 235SA	Pilbara	Goldsworthy Mining Ltd.	6,154,134·00	63·87	45,202,509·00 (b)
T.R. 2041H	West Pilbara	Cliffs W.A. Mining Co. Pty. Ltd.	1,368,758·00	58·99	7,103,975·00 (b)
M.L. 4SA	West Pilbara	Hamersley Iron Pty. Ltd.	18,845,184·38	64·46	131,904,392·87 (b)
M.L. 244SA	Peak Hill	Mt. Newman Mining Co. Pty. Ltd.	18,958,491·00	63·00	128,571,778·00 (b)
M.C. 876H, etc.	South-West	Western Mining Corp. Ltd.	549,450·00	59·84	4,026,365·00 (b)
			47,448,267·38		326,790,877·87
IRON ORE—Pellets (Exported Overseas)					
M.L. 4SA	West Pilbara	Hamersley Iron Pty. Ltd.	2,577,325·56	63·00	25,332,185·56 (b)

TABLE V.—Quantity and Value of Minerals, other than Gold, Reported during the Year 1972—continued

Number of Lease, Claim or Area	Goldfield or Mineral Field	Registered Name of Producer	Quantity Long Tons	Metallic Content	Value \$A
*LIMESTONE (For Building, Burning Purposes, etc.)					
M.C. 1662H	South-West	Bell Bros. Pty. Ltd.	41,078.00	32,862.40
M.C. 1290H	South-West	Bellombra, V.	1,795.00	5,305.50
M.C. 1596/97H	South-West	Hall, H. K.	1,742.00	435.50
M.C. 2133H	South-West	List & Sons Pty. Ltd.	200.00	80.00
M.C. 1040H	South-West	Messina, S.	301.00	325.50
M.C. 1105H, 1702H	South-West	Moore, F. W. & E. M.	1,064.00	2,128.00
M.C. 1093H	South-West	Multari, N.	78.00	253.50
M.C. 1227H	South-West	Korsunski, G.	59,686.00	29,843.00
M.C. 1386H	South-West	Marks, H. O.	71,487.00	35,743.50
M.C. 1988-89H	South-West	Menchetti, E. N.	25,354.00	25,354.00
M.C. 709H	South-West	Snader, R.	30,234.00	15,116.50
M.C. 713H	South-West	Steel Bros. Aust.	5,628.00	3,744.00
M.C. 1660H	South-West	Swan Portland Cement Ltd.	243,943.43	313,369.88
M.C. 1081H	South-West	Swan Portland Cement Ltd.	4,627.75	6,756.57
M.C. 1284H	South-West	W.A. Limestone Co.	54,550.00	81,823.00
	South-West	†Unspecified Producers	586,777.00	625,328.00
			1,128,545.18	1,178,468.85 (c)
*LIMESTONE (For Agricultural Purposes)					
M.C. 50	Dundas	Esperance Lime Supply	675.00	3,260.00
M.C. 1298H	South-West	Waroonia Lime Co.	500.00	500.00
			1,175.00	(c) 3,760.00
		* Incomplete.	† From Private Property not held under the Mining Act.		
LITHIUM ORES (Petalite) (h)					
M.L. 80, etc.	Coolgardie	Australian Glass Manufacturers Co.	1,053.50	Li2O Units 4,424.70	(a) 16,771.25
MAGNESITE					
M.C. 76	Phillips River	Magnesite (W.A.) Pty. Ltd.	30.00	(b) 450.00
MANGANESE (Metallurgical Grade)					
M.C. 244L, etc.	Pilbara	Westralian Ores Pty. Ltd.	97,934.00	Av. Assay Mn % 42.60	1,541,332.00 (b)
MINERAL BEACH SANDS (Ilmenite) (g)					
Sussex Loc. 7	South-West	Cable (1956) Ltd.	11,316.83	Av. Assay TiO2 % 53.77	N.A.
M.C. 746H, 1192H	South-West	Ilmenite Minerals Pty. Ltd.	33,957.98	53.77	N.A.
M.L. 389, etc.	South-West	Western Mineral Sands Pty. Ltd.	134,057.00	54.00	N.A.
M.C. 619H, 620H	South-West	Westralian Sands Pty. Ltd.	105,423.75	58.72	N.A.
M.C. 516H	South-West	Western Titanium N.L.	206,185.10	54.74	N.A.
			490,940.66	5,936,709.61 (b)
MINERAL BEACH SANDS (Upgraded Ilmenite) (g)					
M.C. 516H	South-West	Western Titanium N.L.	6,054.00	91.90
MINERAL BEACH SANDS (Rutile) (g) (h)					
M.C. 516H	South-West	Western Titanium N.L.	3,317.45	TiO2 Tons 3,185.54	(b) 345,185.13
MINERAL BEACH SANDS (Leucoxene)					
Sussex Loc. 7	South-West	Cable (1956) Ltd.	2,617.75	TiO2 Tons 2,282.68	92,803.00
M.C. 746H, 1192H	South-West	Ilmenite Minerals Pty. Ltd.	7,853.25	6,848.03	278,409.00
M.C. 516H	South-West	Western Titanium N.L.	824.00	747.28	49,827.50
M.C. 619H, 620H	South-West	Westralian Sands Ltd.	3,598.60	3,239.20	299,946.00
			14,893.60	13,117.19	(b) 720,985.50

TABLE V.—Quantity and Value of Minerals, other than Gold, Reported during the Year 1972—continued

Number of Lease, Claim or Area	Goldfield or Mineral Field	Registered Name of Producer	Quantity Long Tons	Metallic Content	Value \$A
MINERAL BEACH SANDS (Monazite) (g) (h)					
Sussex Loc. 7	South-West	Cable (1956) Ltd.	103.19	ThO ₂ Units 686.85	13,022.75
M.C. 746H, 1192H	South-West	Ilmenite Minerals Pty. Ltd.	309.56	2,096.96	39,068.25
M.C. 516H	South-West	Western Titanium N.L.	1,261.48	8,195.50	160,274.53
M.C. 619H, 620H	South-West	Westralian Sands Ltd.	647.80	4,210.70	89,391.00
			2,322.03	15,190.01	(b) 301,756.53
MINERAL BEACH SANDS (Zircon) (g) (h)					
Sussex Loc. 7	South-West	Cable (1956) Ltd.	882.28	ZrO ₂ Tons 574.79	26,857.09
M.C. 746H, 1192H	South-West	Ilmenite Minerals Pty. Ltd.	2,646.86	1,724.32	80,541.28
M.C. 516H	South-West	Western Titanium N.L.	47,223.50	31,004.95	1,067,994.55
M.C. 619H, 620H	South-West	Westralian Sands Ltd.	10,854.85	7,109.93	433,361.00
			61,607.49	40,413.99	1,608,753.92 (b)
MINERAL BEACH SANDS (Xenotime) (g) (h)					
M.C. 516H	South-West	Western Titanium N.L.	6.00	Y ₂ O ₃ lb. 4,085.76	(b) 6,603.74
NICKEL CONCENTRATES					
M.L. 150, etc.	Coolgardie	Western Mining Corp. Ltd.	209,269.37	Av. Assay Ni% 12.65	73,620,000.00
M.C. 39W	Broad Arrow	Great Boulder Mines Ltd. and North Kalgurli Mines Ltd.	22,371.34	12.16	7,494,200.00
			231,640.71	81,114,200.00 (b)
NICKEL ORES					
M.C. 1288	Coolgardie	Metals Exploration N.L.	71,273.90	Av. Assay Ni% 2.70	3,298,563.44
M.L. 246, 283	Coolgardie	Anaconda Australia Inc.	1,395.00	2.01	80,934.00
			72,668.90	2.69	3,379,497.44 (c)
OCHRE (Red)					
M.C. 26	Murchison	Universal Milling Co. Pty. Ltd.	542.50	(a) 9,121.86
PETALITE (See Lithium Ores)					
PETROLEUM (Crude Oil)					
1H	Ashburton	West Australian Petroleum Pty. Ltd.	Barrels 15,402,695.00	34,346,900.00 (m)
PETROLEUM (Natural Gas)					
Lic. 1	South-West	West Australian Petroleum Pty. Ltd.	M.C.F. 23,466,978.00	3,176,203.14 (p)
PETROLEUM (Condensate)					
Lic. 1	South-West	West Australian Petroleum Pty. Ltd.	43,629.00	N.A.
SALT					
		State Total (Reported to Mines Department)	2,182,824.00	6,247,617.00 (b)
SEMI PRECIOUS STONES (Quartz)					
P.A. 395	Pilbara	Soklich, F.	lb. 18,501.00	4,434.80
SEMI PRECIOUS STONES (Amethyst)					
M.C. 444	Gascoyne	Soklich, F.	lb. 8,437.00	2,697.65

TABLE V.—Quantity and Value of Minerals, other than Gold, Reported during the Year 1972—continued

Number of Lease, Claim or Area	Goldfield or Mineral Field	Registered Name of Producer	Quantity Long Tons	Metallic Content	Value \$A
SEMI PRECIOUS STONES (Chalcedony)					
M.C. 498	Gascoyne	Soklich, F.	lb. 40,374.00	7,008.50
SEMI PRECIOUS STONES (Moss Opal)					
M.C. 60	Dundas	Soklich, F.	lb. 35,254.00	6,539.83
SEMI PRECIOUS STONES (Moss Agate)					
M.C. 50P	Outside Proclaimed	Wingellina Nickel Australia Ltd.	lb. 35,840.00	4,800.00
SEMI PRECIOUS STONES (Tourmaline)					
M.C. 346	Gascoyne	Soklich, D.	lb. 1,825.00	1,657.00
SEMI PRECIOUS STONES (Chrysoprase)					
M.C. 50P	Outside Proclaimed	Wingellina Nickel Australia Ltd.	lb. 43,121.00	17,156.00
SEMI PRECIOUS STONES (Magnesite)					
M.C. 50P	Outside Proclaimed	Wingellina Nickel Australia Ltd.	lb. 11,184.00	2,780.00
SILVER					
		By-Product Gold Mining	Fine oz. 133,320.50	190,065.61
TALC					
M.L. 433H	South-West	Three Springs Talc Pty. Ltd.	25,602.00	N.A.
TANTO COLUMBITE ORES AND CONCENTRATES (g) (h)					
M.C. 647, 648	Greenbushes	Vultan Minerals Ltd.	27.32	Ta2O5 Units 1,085.65	102,947.00
M.L. 660, etc.	Greenbushes	Greenbushes Tin N.L.	225.86	9,735.77	1,074,098.04
D.C. 195, etc.	Pilbara	Pilbara Tin Pty. Ltd.	12.34	238.82	24,644.00
			265.52	11,110.24	1,201,689.04 (b)
TIN CONCENTRATES (g) (h)					
M.L. 657, etc.	Greenbushes	Greenbushes Tin N.L.	1,375.71	Tons 973.04	2,943,435.00
M.L. 647, 648	Greenbushes	Vultan Minerals Ltd.	104.80	68.06	217,851.00
D.C. 497	Pilbara	J. M. Henderson & Son	3.31	2.41	7,618.00
D.C. 195, etc.	Pilbara	Pilbara Tin Pty. Ltd.	319.45	223.62	693,491.00
D.C. 281, etc.	Pilbara	J. A. Johnston & Sons Pty. Ltd.	132.41	95.21	282,716.00
D.C. 53, etc.	Pilbara	Marshall, W. (Cooglegong Tin Pty. Ltd.)	43.06	29.11	84,633.00
M.C. 1457	Pilbara	McLeod, D. W.	15.51	11.14	32,125.00
	Pilbara	Crown Lands—District Generally	5.07	3.51	10,245.00
M.C. 305WP	West Pilbara	Yule River Mining Pty. Ltd.	5.93	4.06	11,972.00
			2,005.25	1,410.16	4,284,086.00 (b)
VERMICULITE					
M.C. 965	Yilgarn	Mineral By-Products Pty. Ltd.	374.36	(a) 2,266.16

REFERENCES

N.A. Not available for publication.

(a) Estimated F.O.R. value.

(b) Estimated F.O.B. value.

(c) Value at works.

(d) Value of mineral recovered.

(e) Value at pit-head.

(f) Estimated value based on current published prices.

(g) Only results of sales realised during the period under review.

(h) Metallic content calculated on assay basis.

(i) Concentrates.

(j) By-Product of Gold Mining.

(k) By-Product of Tin Mining.

(l) Value computed by the Dept. of Mines based on the price for Alumina F.O.B. Jamaica.

(m) Value based on the price per barrel as assessed by the Tariff Board for Barrow Island Crude Oil at Kwinana.

(n) Nominal value.

(o) Estimated nominal F.O.B. value based on the current price for Nickel Cathodes.

(p) Nominal value at Well-Head.

NOTE—If utilised for publication please acknowledge release from the Hon. Minister for Mines.

TABLE VI
TOTAL MINERAL OUTPUT OF WESTERN AUSTRALIA

Recorded mineral production of the State to 31st December, 1972, showing for each mineral the progressive quantity produced and value thereof, as reported to the Department of Mines; including Gold (Mint and Export) as from 1886, and Other Minerals as from commencement of such records in 1899.

Mineral	Quantity	Value \$A
Abrasive Silica Stone	1.50	18.00
Alumina (From Bauxite)	5,772,778.00	365,794,640.00
Alumite (Crude Potash)	9,073.05	431,729.44
Antimony Concentrates (a)	9,829.69	484,994.00
Arsenic (a)	38,674.08	1,494,410.00
Asbestos—		
Anthophyllite	509.35	13,547.42
Chrysotile	11,239.38	989,397.40
Crocidolite	152,466.74	33,496,644.98
Tremolite	1.00	50.00
Barytes	8,800.20	125,551.90
Bauxite (Crude Ore) (g)	36,741.00	187,069.50
Beryl	3,796.87	985,922.30
Bismuth	16,259.70	14,495.67
Building Stone (g)—		
Chrysotile—Serpentine	4.45	106.00
Granite (Facing Stone)	1,042.00	38,904.00
Lepidolite	8.35	146.00
Prase	9.50	275.00
Quartz (Dead White)	1,592.23	33,914.00
Quartz Crystal	210.00	3,192.00
Quartz	18,822.23	220,861.55
Quartzite	9,109.00	39,499.00
Sandstone	654.00	3,924.00
Sandstone (Donnybrook)	83.00	3,486.00
Slate	235.00	2,115.00
Spongolite	3,707.50	40,766.00
Tripolite	264.00	264.00
Calcite	5.00	50.00
Chromite	14,419.05	416,593.50
Clays—		
Bentonite	12,236.83	79,546.52
Brick, Pipe and Tile Clays (g)	889,511.95	1,373,965.16
Cement Clays	444,870.37	783,550.46
Fireclay	1,123,070.16	1,409,304.56
Fullers Earth	459.40	3,821.00
White Clay—		
Ball Clay	28,981.60	198,085.60
Kaolin	6,408.99	24,739.97
Coal	42,664,662.13	143,508,100.00
Cobalt (Metallic By-Product Nickel Mining)	903.02	2,883,985.00
Copper (Metallic By-Product Nickel Mining)	5,396.68	4,661,138.00
Copper (Metallic By-Product) (a)	191.50	65,375.10
Copper Ore and Concentrates	308,414.41	10,783,226.03
Corundum	63.15	1,310.00
Cupreous Ore and Concentrates (Fertiliser)	87,120.72	3,311,561.30
Diamonds	(e)	48.00
Diatomaceous Earth (Calcined)	520.00	15,991.00
Dolomite	3,046.82	26,118.20
Emeralds (cut and rough)	18,799.68	4,642.00
Emery	21.15	750.00
Felspar	71,945.61	544,385.06
Fergusonite30	782.80
Gadolinite	1.00	224.00
Glass Sand	(g) 696,791.90	506,739.33
Glauconite	(f)(h) 6,467.00	300,769.00
Gold (Mint and Export)	68,759,359.95	1,121,050,370.00
Graphite	153.20	2,608.40
Gypsum	1,552,090.92	3,701,096.50
Iron Ore—		
Pig Iron Recovered	848,405.08	42,507,344.12
Ore Exported	201,752,329.12	1,396,308,777.81
Pellets Exported	9,562,841.05	97,662,801.03
Locally used Ore	7,744,099.00	42,474,879.00
For Flux	58,064.35	74,096.00
Jarosite	9.54	75.00
Kyanite	4,215.69	43,562.00
Lead Ores and Concentrates	481,841.25	10,618,881.56
Limestone (g)	7,955,482.35	8,327,794.42
Lithium Ores—		
Petalite	7,695.98	120,641.20
Spodumene	106.58	3,627.20
Magnesite	30,855.64	335,422.86
Manganese—		
Metallurgical Grade	1,841,970.56	40,436,952.08
Battery Grade	2,218.25	90,860.20
Low Grade	5,054.36	81,538.20
Mica	32,930.00	7,968.48

TABLE VI.—Total Mineral Output of Western Australia—continued

Mineral	Quantity	Value
Mineral Beach Sands—		
Ilmenite Concentrates	5,289,943·35 tons	54,353,557·93
Monazite Concentrates	23,603·83	2,781,929·04
Rutile	13,255·12	1,078,565·19
Leucoxene	50,759·35	2,905,189·14
Zircon	336,551·13	9,359,432·10
Xenotime	129·00	159,927·32
Crude Concentrates (Mixed)	155·95	1,553·00
Molybdenite	77·50	1,730·00
Nickel Concentrates	910,205·51	285,466,914·00
Nickel Ore	195,004·12	8,270,417·55
Ochre—		
Red	12,103·43	246,969·11
Yellow	447·60	5,955·50
Peat	3,987·55	62,633·00
Petroleum (Crude Oil)	76,848,441·00 bbls.	221,502,262·73
(Natural Gas)	24,688,199·00 m.c.f.	(l)3,334,961·87
(Condensate)	43,269·00 bbls.	N.A.
Palladium (By-Product Nickel Mining)	320·75 troy ozs.	9,656·00
Platinum (By-Product Nickel Mining)	1,921·87	192,385·00
Phosphatic Guano	11,857·06 tons	145,420·90
Pyrites Ore and Concentrates (For Sulphur) (b)	1,353,268·24	16,309,423·52
Quartz Grit	829·50	1,400·70
Salt	6,951,972·62	22,245,316·00
Semi-Precious Stones—		
Amethyst	50,596·90 lb.	18,882·44
Beryl (Coloured)	200·00	100·00
Chalcedony	157,231·00	27,114·30
Chrysoprase	269,410·00	121,142·00
Dravite	19,048·00	15,593·78
Magnesite	11,184·00	2,780·00
Moss Opal	117,221·00	20,281·43
Moss Agate	35,840·00	4,800·00
Opaline	25·00	7·50
Prase	8,720·00	729·50
Quartz	18,501·00	4,434·80
Tiger Eye Opal	120·00	194·00
Topaz (Blue)	7·00	3·50
Tourmaline	1,825·00	1,657·00
Sillimanite	2·00 tons	26·00
Silver (c)	13,413,221·96 fine ozs.	8,610,507·89
Soapstone	565·40 tons	3,855·70
Talc	218,780·21	4,719,451·65
Tanto/Columbite Ores and Concentrates	1,675·65	3,745,817·88
Tin	29,838·65	25,097,351·76
Tungsten Ore and Concentrates—		
Scheelite	169·18	143,424·24
Wolfram	304·96	125,810·16
Vermiculite	2,560·84	28,048·48
Zinc (Metallic By-Product) (d)	2,887·75	(j)
Zinc Ore (Fertiliser)	20·00	200·00
Total Value to 31st December, 1972		\$3,984,955,648·86

(a) By-Product from Gold Mining.

(b) Part By-Product from Gold Mining.

(c) By-Product from Gold, Copper and Lead Mining.

(d) By-Product from Lead Mining.

(e) Quantity not recorded.

(f) Value of mineral or concentrate recovered.

(g) Incomplete.

(h) Mineral Recovered.

(i) Assayed Metallic Content.

(j) Value included in Lead Value.

(k) Based on the price assessed by the Tariff Board for Barrow Island crude oil at Kwinana.

(l) Nominal well-head value.

Footnote.—Comprehensive mineral production records maintained in the Statistical Branch of the Department of Mines show locality, producers, period, quantity, assayed or metallic content, and value of the various minerals listed above.

TABLE VII

Showing average number of men employed above and below ground in the larger mining companies operating in Western Australia during 1971 and 1972.†

Company	1971			1972		
	Above	Under	Total	Above	Under	Total
Gold*—						
Central Norseman Gold Corporation N.L.	126	100	226	128	91	219
Gold Mines of Kalgoorlie (Aust.) Ltd. (Boulder)	316	137	453	319	129	448
Hill 50 Gold Mine N.L.	64	52	116	60	52	112
Lake View & Star Ltd.	257	250	507	260	278	538
Gold Mines of Kalgoorlie (Aust.) Ltd. (Mt. Charlotte)	12	113	125	14	128	142
North Kalgurli (1912) Ltd.	143	135	278	126	127	253
All other operators	37	33	70	159	111	270
State Average	955	820	1,775	1,066	916	1,982
Alumina (from Bauxite)—						
Alcoa of Australia (W.A.) N.L.	1,374	1,374	1,671	1,671
Coal—						
Griffin Coal Mining Co. Ltd.	177	177	174	174
Western Collieries Ltd.	129	317	446	132	311	443
Iron Ore—						
Charcoal Iron & Steel	8	8	11	11
Dampier Mining Co. Ltd.	422	422	373	373
Goldsworthy Mining Ltd.	438	438	457	457
Hamersley Iron Pty. Ltd.	971	971	985	985
Mt. Newman Mining Co. Pty. Ltd.	821	821	804	804
Western Mining Corporation	94	94	92	92
Cliffs Western Australian Mining Co. Pty. Ltd.	104	104
Mineral Beach Sands—						
Cable (1956) Ltd.	14	14	5	5
Ilmenite Minerals Pty. Ltd.	102	102	54	54
Western Mineral Sands Pty. Ltd.	43	43	45	45
Westralian Sands Ltd.	62	62	71	71
Western Titanium N.L.	178	178	159	159
Nickel—						
Great Boulder Gold Mines Limited	304	108	412	264	67	331
Metals Exploration N.L.	56	94	150	70	116	186
Western Mining Corporation	783	516	1,299	763	498	1,261
Anaconda Australia Inc.	12	14	26
Petroleum—Crude Oil—						
West Australian Petroleum Pty. Ltd.	106	106	133	133
Salt—						
Lefroy Salt Pty. Ltd.	15	15
Leslie Salt Co.	47	47	28	28
Texada Mines Pty. Limited	197	197	173	173
Dampier Salt Limited	89	89
All other minerals	336	15	351	280	10	290
State Total (Other than Gold)	6,677	1,050	7,727	6,949	1,016	7,965

* For details of individual years prior to 1967—see Annual Report for 1966 or previous reports.

† Effective workers only and totally excluding non-workers for any reason whatsoever.